

CBR-SMD RF COG, Ceramic, High Q, 5.4 pF, +/-0.1 pF, 250 VDC, COG, SMD, Fixed, RF, Ultra High Q, Low ESR, Class I, 0603

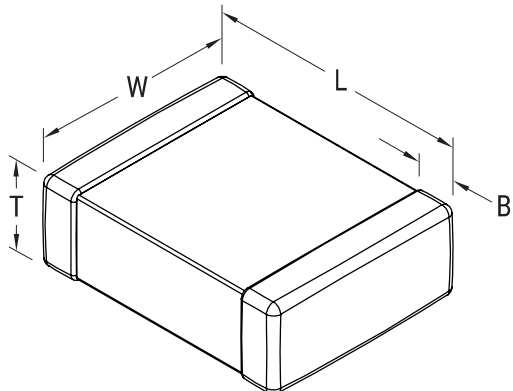

**Dimensions**

<b>L</b>	1.6mm +/-0.1mm
<b>W</b>	0.8mm +/-0.1mm
<b>T</b>	0.8mm +/-0.07mm
<b>B</b>	0.4mm +/-0.15mm

**Packaging Specifications**

<b>Packaging:</b>	T&R, 180mm, Plastic Tape
<b>Packaging Quantity:</b>	4000

**General Information**

<b>Supplier:</b>	KEMET
<b>Series:</b>	CBR-SMD RF COG
<b>Style:</b>	SMD Chip
<b>Description:</b>	SMD, Fixed, RF, Ultra High Q, Low ESR, Class I
<b>Features:</b>	Ultra High Q, Low ESR, Class I
<b>RoHS:</b>	Yes
<b>Termination:</b>	Tin
<b>Marking:</b>	No
<b>Miscellaneous:</b>	Minimum Q = 908
<b>Notes:</b>	Solder Wave or Solder Reflow
<b>Chip Size:</b>	0603

**Specifications**

<b>Capacitance:</b>	5.4 pF
<b>Capacitance Tolerance:</b>	+/-0.1 pF
<b>Voltage DC:</b>	250 VDC
<b>Dielectric Withstanding Voltage:</b>	500 V
<b>Temperature Range:</b>	-55/+125C
<b>Temperature Coefficient:</b>	COG
<b>Dissipation Factor:</b>	0.20%
<b>Aging Rate:</b>	0% Loss/Decade Hour
<b>Insulation Resistance:</b>	10 GOhms
<b>Quality Factor:</b>	908