

KEMET, SCR, AC Line Filters, Common Mode, 2000 uH

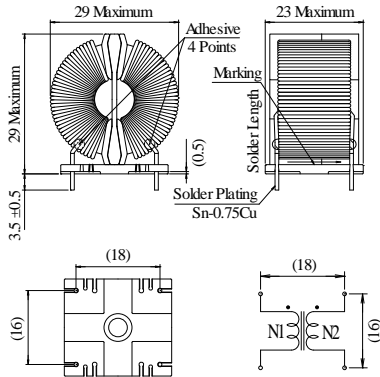

Dimensions

L	29mm MAX
T	23mm MAX
H	29mm MAX
LL	3.5mm +/-0.5mm
S	16mm NOM

Packaging Specifications

Packaging:	Tray
Packaging Quantity:	240
Weight:	25 g

General Information

Series:	SCR
Style:	Through-Hole
Features:	High Impedance
RoHS:	Yes
Notes:	Lead Spacing (S/S1) Are For Reference Only.
Miscellaneous:	Temperature Rise Maximum: 55 K

Specifications

Voltage AC:	250 VAC/VDC
Voltage DC:	250 VDC
Inductance:	2 mH
Current:	8 A
Temperature Range:	-25/+120C
DC Resistance:	15.9 mOhms