

KEMET, SCR22, AC Line Filters, Common Mode, 7500 uH

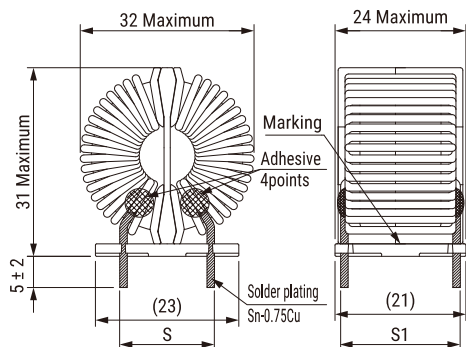

Dimensions

D	32mm MAX
L	32mm MAX
T	31mm MAX
H	24mm MAX
LL	5mm +/-2mm
S	14mm NOM
L2	23mm NOM

Packaging Specifications

Packaging:	Tray
Packaging Quantity:	200
Weight:	34 g

General Information

Series:	SCR22
Style:	Through-Hole
Features:	High Impedance, Space Saving
RoHS:	Yes
Miscellaneous:	70 (K) Temperature Rise Max.

Specifications

Voltage AC:	250 VAC
Inductance:	7500 uH
Current:	6 A
Temperature Range:	-25/+120C
DC Resistance:	42 mOhms