

# Wiha Catalogue 2015 - 2017



Wiha Schonach  
(Headquarters)



Wiha Mönchweiler



Wiha Buchs (KWB AG)



Wiha Danzig



Wiha Song Cong

Dear Wiha customer,  
Dear business associate,

» Where are good ideas and innovative solutions created? In practice, where users work. Identifying needs, understanding and implementing these requires not only technical expertise but a view of the complete situation and an eye for details. Wiha customers have been able to rely for more than 70 years on our proximity to the practical world and our feeling for solutions that facilitate work.

We wish to express our gratitude for your trust in our brand, service, quality and solution expertise with many innovative further developments.

This annual catalogue contains a series of new products, for example the new magazine bit holder. The space-saving handle magazine contains a compact exchange bit system for standard bits and slimBits. A new opening mechanism ensures that the user receives the correct bit simply through the push of a button and a lifting function. The new BiCut pliers also demonstrate genuine user proximity. Users gain a doubling in cutting strength by simply pressing a button – 200% BiCut power! The SoftFinish® screwdriver is celebrating its 15th anniversary.

Attractive packaging with optically relaunched displays and elegant stand walls in anthracite ideally complement visual appearances and are transformed into real eye-catchers.

I cordially invite you to discover the new catalogue. Browse, see and wonder about the high diversity and professional quality of our tools, and experience in words and images how our tools are able to make your everyday work even more successful. Finding ideal solutions for you is the philosophy that drives us. Typical in fact for Wiha premium tools.

With best regards,

Wilhelm Hahn



## Inspiration 2014

by Innovation

### Wiha Services

**Orders:**

- By phone, fax, email or EDI

**Consulting service:**

- Field service incl. key accounts everywhere on site
- Internal service can be reached from Mon. – Fri. 7:30 am – 5 pm CET by phone

**eBusiness** (for catalogue articles):

- Media-neutral database for data export
- eClass classification
- BMEcat Version 1.2

**Warranty:**

- 5-year warranty on materials and workmanship

**Quality level:**

- ISO 9001:2008
- Production depth far above average
- Virtually 100% own production

**Patents and licenses:**

- over 80 trademark rights (patents or registered designs)
- long-term cooperation with licensors guarantees maximum quality and fitting accuracy of tools

**Special articles:**

- Production of semi-standard and drawing-dependent tools. Just ask us!









**Sales aids:**

- CD or DVD with article data and photos
- Equipment consulting with sales aids
- Presentation materials













# Wiha product innovations.

The clever addition to our assortment.





## Screwdriver

PicoFinish TORX PLUS® Security IPR		38
Magazine bit holder LiftUp electric with 6 slimBits. Doubled security. – Slotted/ PH/ PZ Xeno		54
SoftFinish® electric slimFix set, 6 pcs. – Slotted/ PH/ PZ/ Xeno SL/PZ2		53
SoftFinish® electric slimBits – Hex/ Set, 7 pcs.		57
Topra 2K electric Ratchet screwdriver with pistol grip for individually tested VDE torque		67
Topra 2K electric blades – TORX®/ Hex/ Hex nut driver		67
PicoFinish electric – Slotted/ PH/ Set, 6 pcs.		69
Volt Detector		70

## Torque screwdrivers

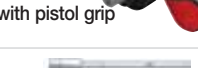
slimTorque starter set, 5 pcs. – bit holder, Torque-Setter, slimBits SL/PZ		93
slim Selection set, 11 pcs.		97
Wiha Torque TR The intelligent torque tool		101
TorqueVario®-S TR		102
TorqueFix® TR		102
easyTorque TR		104
Universal bit holder Torque TR/Topra 2K		104
Adapter blade Torque TR/Topra 2K		105
TorqueVario®-S TR VDE – 3 - 12 Nm		105
Torque TR electric electric reversible blade – TORX®/ Hex/ Hex nut driver		107
TorqueFix®-Key – 0,9 - 4,0 Nm		107
Torque reversible blade – Hex/ TORX®/ TORX PLUS®		107

## Torque screwdrivers

SYSTEM 6 Topra 2K ratchet screwdriver with pistol grip		111
SYSTEM 6 nut driver for hex nuts		112
SYSTEM 6 adapter Topra 2K		113
SYSTEM 6 reversible blades set, 11 pcs.		117

## L-keys

TORX® titanium silver Surface for premium quality demands – TORX®/ Set 13 pcs.		154
--	---	-----



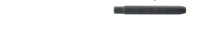



## Special tools

Universal switching cabinet key electro		44
Screw extractor hex		45

## Bits

Wiha MaxxTor-Bits The dual components bit – 29er / 49er Robertson		177
DryWall stop bit, PH		189
Industrial bits Specialist for fastening: – Halfmoon Hex/ PH/ TORX®/TORX PLUS® – Wing shape PH/ TORX®/ TORX PLUS®		199
Adapter Drive G 12,5 with quick release chuck		212
CentroFix Force Quick release holder magnetic 1/4"		216
CentroFix SuperSlim Quick release holder magnetic 1/4"		216
MagicFlip Force universal holder with ring magnet		217
Industrial bit holder with magnet, Halfmoon		217
Magazine bit holder LiftUp Several assortments: – 25 mm bits: Slotted/ PH/ PZ/ TORX® – 70 mm bits: Slotted/ PH/ PZ/ TORX® – SB variants		225
Magazine bit holder Topra 2C magnetic Several assortments: – 25 mm bits: Slotted/ PH/ PZ/ TORX®/ Hex – SB variants		226
BitBuddy – Several assortments 29er: PZ/ Hex – SB variants		227
BitBuddy displays – 3 variants		230
FlipSelector – Several assortments: Torsion Dura, Diamant, TiN, HOT, ZOT, SIT, Inkra, stainless steel – Slotted/ PH/ PZ/ TORX®/ TORX® H/ Hex – SB variants – Display		231
		238
		243

## Pliers

Wiha BiCut – more power by pushing the button. – Power: double cutting forces for extremely hard material – Powerful: up to 50% less hand-force needed for cutting applications		266
		272
		282
		291
TriCut – Installation pliers		273
		292
Water pump pliers Professional electric		274
		274
Crimping pliers Professional electric		274
Cable stripping knife		279
Industrial electric – Range – Set, 3 pcs. – Display, 10 pcs.		285
		285
Diagonal cutter for plastic materials, Classic		293

## Hammers

Dead-blow hammer with polyamide (nylon®) faces		338
--	---	-----

# Wiha product line directory.

Where do I find it?

## Screwdrivers

The Wiha screwdriver concept	
Wiha SoftFinish®	14
Wiha SoftFinish® with mm-scale	17
Wiha SoftFinish® Stubby screwdrivers	18
Wiha MicroFinish®	27
Wiha Classic screwdrivers	30
Wiha spezial tools	33
Wiha Wooden handle screwdrivers	34
Wiha PicoFinish	36
Wiha universal scraper	42

Wiha VDE screwdrivers	
Wiha SoftFinish® electric slimFix	50
Wiha magazine bit holder LiftUp electric	54
Wiha SoftFinish® electric slimVario	56
Wiha SoftFinish® electric	61
Wiha SoftFinish® electric Xeno	64
Wiha Topra 2K electric	66
Wiha Classic electric	68
Wiha PicoFinish electric	69
Wiha Volt Detector	70
Wiha voltage testers	70
Wiha Torque VDE screwdrivers	88

Wiha ESD screwdrivers	
Wiha SoftFinish® ESD	72
Wiha Precision ESD	75
Wiha Ceramic	79
Wiha special tools	
Wiha seal scraper, trim pin remover	33
Wiha square reamer, awl	33
Wiha universal scraper	42
Wiha magnetisers/ demagnetisers	44
Wiha screw extractor set	45

## Torque screwdrivers

The Wiha torque range	
Wiha iTorque	86

Wiha torque screwdrivers	88
Wiha Torque VDE screwdrivers	92
Wiha Torque ESD screwdrivers	98

Wiha Torque TR tools	102
Wiha T-handle torque tools	103
Wiha Torque TR VDE tools	105
Wiha TorqueFix® key torque screwdriver	106

## Reversible blade systems

Wiha reversible blade systems	
Wiha SYSTEM 6	110
Wiha SYSTEM 6 Topra 2K	110
Wiha SYSTEM 4	118

Wiha ESD reversible blade systems	
Wiha SYSTEM 6 ESD	116
Wiha SYSTEM 4 ESD	123

## L-keys

Wiha holder overview	124
Wiha ErgoStar holder	130
Wiha MagicRing®	132
Wiha Hex L-keys with MagicRing®	133
Wiha hex L-keys	136
Wiha PocketStar	158
Wiha Mini PocketStar	162

Wiha MagicSpring®	
Wiha TORX® MagicSpring® products	148
Wiha TORX® ball end L-keys	152
Wiha TORX® Titanium silver	154
Wiha TORX® L-keys	155
Wiha TORX® Tamper Resistant L-keys	157
Wiha TORX PLUS® L-keys	157

Wiha T-handles	
Wiha ComfortGrip	163
Wiha T-handle	166
Wiha key and flag handles	
Wiha key handle	172
Wiha flag handle	173
Wiha offset screwdrivers	173

## Bits

Individual bits	
Wiha MaxxTorBit 29er   49er	176
Wiha DuraBit®	178
Wiha Diamond bit	180
Wiha Torsions bit	182
Wiha Inkra bit	187
Wiha Standard bit	188
Wiha stainless steel bit	193
Wiha Professional bit	199
Wiha Industrial bits	199
Wiha threaded bit	200

Wiha special bits	201
Wiha drive system C 4	202
Wiha drive system C 8 (5/16"), G 7	204
Wiha CentroFix System	
Wiha drill bits	206
Wiha nut driver product line	
Wiha adapters	212
Wiha impact screwdriver assortment	213
Wiha Gripper	214
Bit holder	
Wiha bit holder for power machines	216

Wiha bit holder with handle	218
Wiha Offset screwdriver	219
Wiha magazine bit holder	220
Bit ranges	
Wiha BitBuddy	228
Wiha XLSelector	234
Wiha FlipSelector	237
Wiha Collector	244
Wiha bit case	246
Wiha bit bulk pack	246
Wiha SB bit range	
	246

## Pliers / Tweezers

Wiha Inomic®. Pliers. Reinvented.	
Wiha Inomic®	260
Wiha Inomic® VDE	262

Wiha quality pliers	
Wiha Professional	264
Wiha Professional electric	270
Wiha Industrial	260
Wiha Industrial electric	285

Wiha Basic	289
Wiha Electronic	302
Wiha Professional ESD	305
Wiha quality tweezer	
	310

## Soft-face hammers

Wiha Safety soft-face hammer	332
------------------------------	-----

Wiha dead-blow hammer	337
-----------------------	-----

## Measuring tools

Wiha folding rulers	342
digitMax, calliMax, dialMax, dialMax ESD	343

Wiha callipers	344
Longlife Plus Composite	344
Longlife/ Longlife All in One/ Longlife Plus	344

## Articulated hoses

Wiha maxiflex® system 3200	348
----------------------------	-----

Wiha maxiflex® system 3400	349
----------------------------	-----



# Wiha content.

Product range.



► See symbols key,  
page 390

	<b>Wiha Awards.</b>	6 – 7
	<b>Screwdrivers</b>	8 – 79
	<b>Torque screwdrivers</b>	80 – 107
	<b>Reversible blade systems</b>	108 – 123
	<b>L-keys</b>	124 – 173
	<b>Bits</b>	174 – 253
	<b>Pliers</b>	254 – 313
	<b>Mixed sets</b>	314 – 329
	<b>Soft-face hammers</b>	330 – 339
	<b>Measuring tools</b>	340 – 346
	<b>Articulated hoses</b>	347 – 349
	<ul style="list-style-type: none"> <li>How to find the correct tip? 350 – 351</li> <li>VDE in detail 352 – 353</li> <li>Technical specifications 354 – 359</li> <li>Wiha Values 360 – 362</li> <li>Article series 364 – 368</li> <li>List of order numbers 369 – 384</li> <li>iPOSS 385 – 388</li> </ul>	

# Wiha Values.

Tuev-Certificate. Awards.

ZERTIFIKAT ♦ CERTIFICATE ♦ CERTIFICADO ♦ CERTIFICADO ♦ CERTIFICAT



## CERTIFICATE

The Certification Body  
of TÜV SÜD Management Service GmbH  
certifies that



**Wiha Werkzeuge GmbH**  
Obertalstraße 3-7  
D-78136 Schonach

including the  
sites and scope of application  
see enclosure

has established and applies  
a Quality Management System.  
An audit was performed, Report No. 70012578  
Proof has been furnished that the requirements according to

### ISO 9001:2008

are fulfilled. The certificate is valid until 2015-11-07  
Certificate Registration No. 12 100 20764 TMS



Munich, 2012-11-19  
Page 1 of 2



GMS-TGA-ZM-07-02

TÜV SÜD Management Service GmbH • Zertifizierungsstelle • Ridlerstraße 65 • 80339 München • Germany



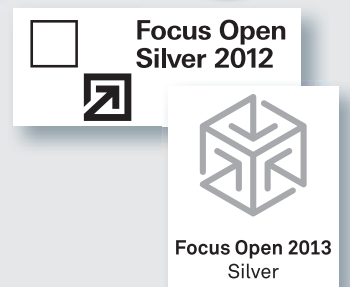

**Tested safety with industrial quality:**  
all Wiha VDE tools are individually tested in a water bath at 10,000 volts according to IEC 60900:2012.

**For use with electrostatically endangered components:**  
all Wiha ESD tools are equipped with dissipative handles with a defined surface resistance of  $10^6 - 10^9$  ohms.





The iF product design award counts as one of the most renowned international design awards and represents both innovation and outstanding design excellence.



The red dot award is one of the most renowned international design awards, featuring one of the world's largest exhibitions of contemporary design.

The "red dot" seal of quality is awarded exclusively to especially creative, innovative and high-quality products.



The Design Center Stuttgart regularly announces the international design award according to a special thematic focus.

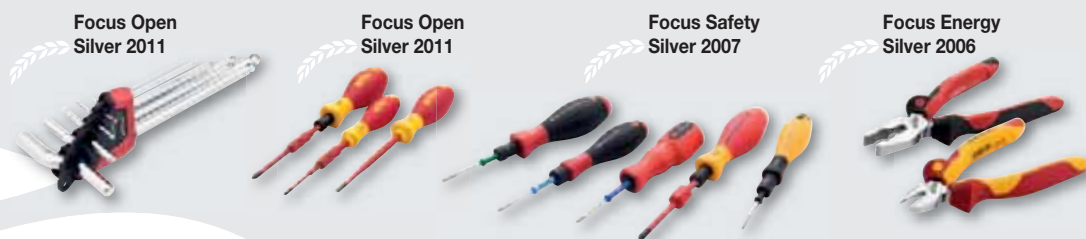

### Innovation Quality Reliability

Our system of values is reflected in the following areas:

#### Company

- We develop and manufacture top-quality and highly functional tools which reflect their innovative design.
- We are an independent, family-owned company.
- We are experiencing strong and healthy growth.

#### Processes

- We optimise internal process by the use of state-of-the-art technologies and concepts.
- We guarantee the highest possible inventory availability and a comprehensive service.
- We enjoy an active and committed collaboration with our customers, sales partners and suppliers all over the world.

#### Employees

- We are a team, with each member being directly responsible for their own actions, as well as being target and performance-oriented.
- Ongoing training and support strengthen the commitment and qualification of our employees.
- In all our actions, we are fully aware of our responsibility to the environment.

# Wiha screwdrivers.

Wiha makes it possible: Optimal handling for perfect work.



	Slotted	Phillips PH	Xeno PH	Pozidriv PZ	Xeno SL/PZ	TORX®	TORX® Tamper Resistant	TORX PLUS®	For internal hex screws	For hex nuts	For internal square screws	For internal triangular screws	Slotted nuts
SoftFinish® screwdrivers	15 22-23	16 22-23		16 22-23		18-19 24	19	19	20	21 25		21	20
Screw-holding screwdrivers	15	16											
SoftFinish® with mm scale	17	17		17									
SoftFinish® Stubby-screwdrivers	18	18		18									
MicroFinish screwdrivers	27 29	27 29		28 29		28				28			
Classic screwdrivers	31-32	31 32		31 32		31			32	32			
Pocket screwdrivers	33												
Wooden handle screwdrivers	35	35		35									
PicoFinish screwdrivers	37 40	37 40		37		37 41	38	38	38 39	39 41			
SoftFinish® electric slimFix screwdriver	51-53	51-53	51	51-53	51-53	51 53						51	
Magazine bit holder LiftUp electric	55	55			55								
SoftFinish® electric slimVario screwdriver	57-60	57-60	57	57-58 60	57-59	57-60						57 58	
SoftFinish® electric screwdriver	61 63	62 63	65	62 63	65	62			62	62 63	62		
Topra 2K electric						67			67	67			
Classic electric screwdriver	68	68											
PicoFinish electric	69	69											
Voltage testers	71												
SoftFinish® ESD screwdriver	73 74	73 74		73		74							
SoftFinish® ESD Stubby-screwdrivers	73	73		73									
Precision ESD	76	76		76		77		77	76	76			
Ceramic	79	79											



## Screwdriver range

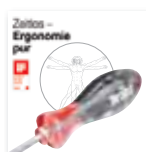

<b>Wiha SoftFinish concept.</b> Innovative. Timeless. Ergonomics at its best.....	10
Handle design adapted to screw sizes.....	11
Tangible advantages.....	12
Wiha SoftFinish® range.....	13



<b>Wiha SoftFinish®.</b> The convenient expert for dry applications.....	14 – 25
---	---------



<b>Wiha MicroFinish.</b> The specialist for wet and oily applications.....	26 – 29
---	---------



<b>Wiha Classic.</b> The classic for a range of uses.....	30 – 32
--	---------



<b>Wiha special tools.</b> Scraper, clamp lifter.....	33
Reamer, awl and small screwdriver.....	33
Magnetiser. Screw extractor.....	44 – 45



<b>Wiha wooden handle.</b> The all-rounder for woodworking applications.....	34 – 35
---	---------



<b>Wiha PicoFinish.</b> The comfortable precision screwdriver.....	36 – 41
---	---------



<b>Wiha universal scraper.</b> Easily removes sealing, paint and glue.....	42 – 43
---	---------



<b>Wiha VDE screwdrivers.</b> For safety and quality	
- Wiha slim family.....	46 – 47
- Wiha slim selection set.....	48 – 49



<b>Wiha SoftFinish® electric slimFix.....</b>	50 – 53
---	---------



<b>Wiha Magazine bit holder LiftUp electric.</b> With 6 slimBits.....	54 – 55	<b>NEW</b>
--	---------	------------



<b>Wiha SoftFinish® electric slimVario.....</b>	56 – 60
---	---------



<b>Wiha SoftFinish® electric.....</b>	61 – 63
<b>Wiha SoftFinish® electric Xeno.....</b>	64 – 65



<b>Wiha Topra 2K electric.</b> Pure power for electrical applications.....	66 – 67	<b>NEW</b>
---	---------	------------



<b>Wiha Classic electric.....</b>	68
-----------------------------------	----



<b>Wiha PicoFinish electric.....</b>	69	<b>NEW</b>
--------------------------------------	----	------------



<b>Wiha Volt Detector.....</b>	70	<b>NEW</b>
--------------------------------	----	------------



<b>Wiha single-pole voltage tester.....</b>	71
---	----



<b>Wiha ESD screwdrivers.</b> For use on electrostatically sensitive components.	
---	--



<b>Wiha SoftFinish® ESD.....</b>	72 – 74
----------------------------------	---------



<b>Wiha Precision ESD.....</b>	75 – 78
--------------------------------	---------



<b>Wiha Ceramic.....</b>	79
--------------------------	----

# Wiha SoftFinish concept.

Innovative. Timeless. Ergonomics at its best.



product  
design  
award

1997

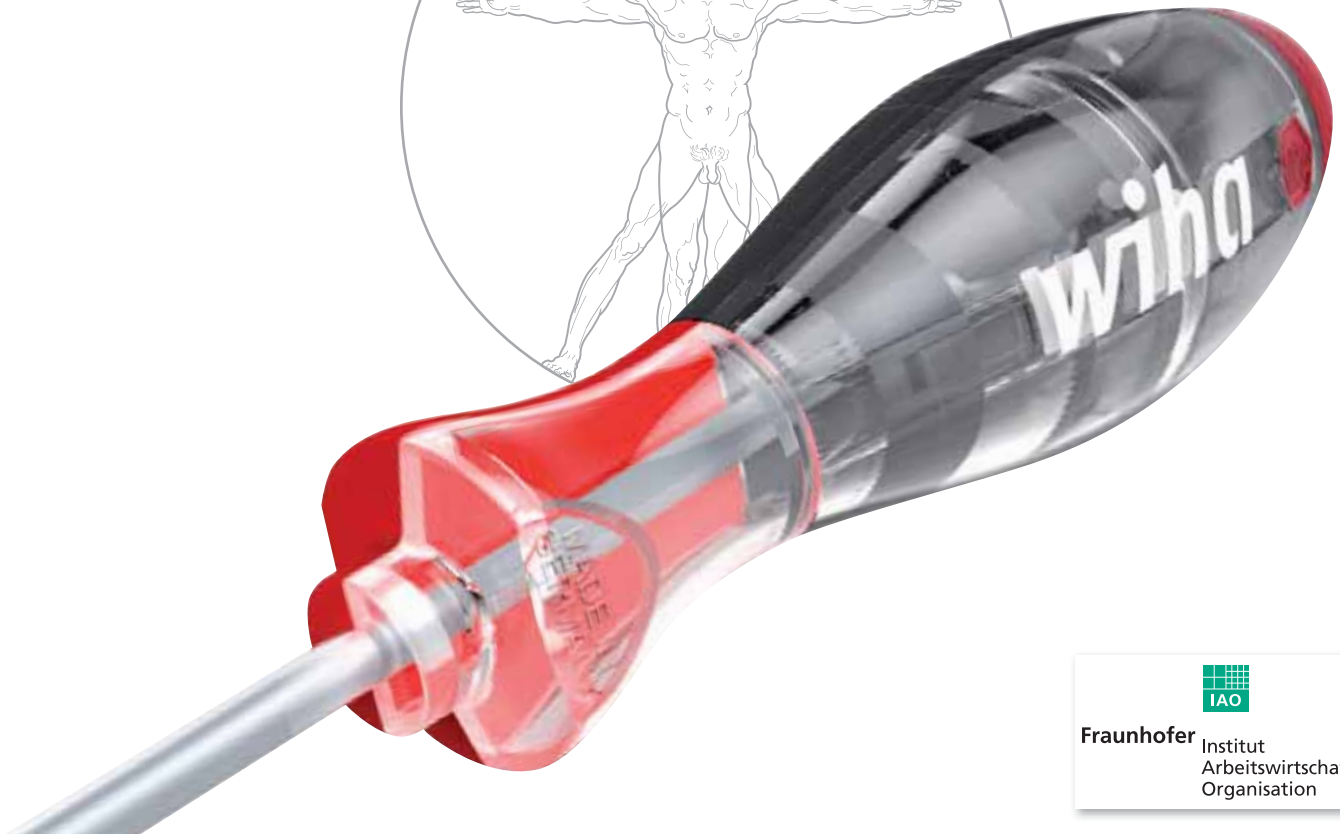

Fraunhofer  
Institut  
Arbeitswirtschaft und  
Organisation

With its innovative handle concept, Wiha designs for the hand. Existing handle designs available on the market are not ergonomically designed with the constancy of human hands in mind. The handle sizes are created by scaling a basic style. This causes disadvantages for users when guiding the tool or transmitting torque.

Wiha is breaking new ground and designing its handle to suit the constancy of all hands.

Thanks to four different SoftFinish® handle sizes, the basic requirements for fastening are fulfilled ideally. Thus, each Wiha handle provides a perfectly correlated ratio of guidance, speed and torque for any task.

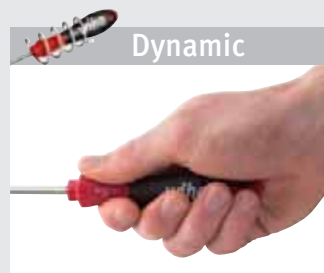

Special practical conditions result for

- **quick turning:** consistent consideration of motor skills
- **maximum power transmission:** Comfortable and loss-free transmission of physical strength, even for intensive fastening.

Power-turning and quick-turning zones (length) are integrated in the four handle sizes in various forms.

Handle design adapted to screw sizes.

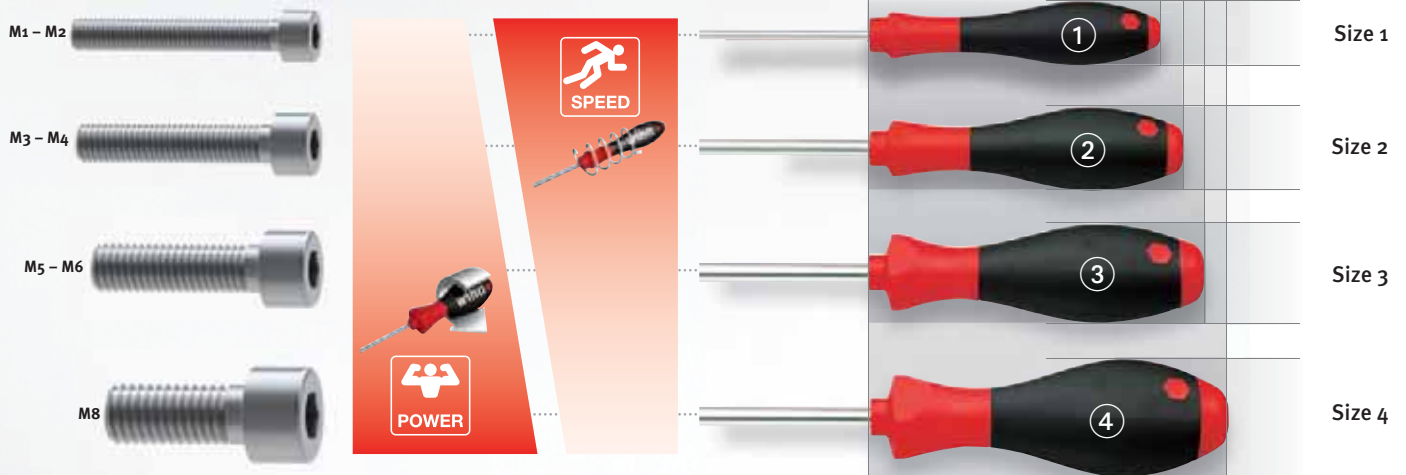

### Dynamic



#### Design features for turning speed:

- Small quick-turning zone with circular cross-section for fast turning at the beginning of the handle
- Extended slim handles with tapered handle ends for stable guidance
- Perfect for sensitive fastenings



### Power

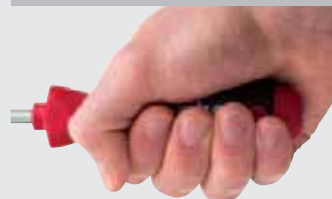

#### Design features for power transmission:

- Power turning zone with extra large, octagonal cross-section for comfortable maximum power transmission
- All the fingers are positioned on the handle and add to power transmission
- No painful edges
- Ideal for large screws with a high torques

# Wiha SoftFinish®.

Tangible advantages.



product  
design  
award

1997



**Fraunhofer** Institut  
Arbeitswirtschaft und  
Organisation



**Wiha SoftFinish®.**

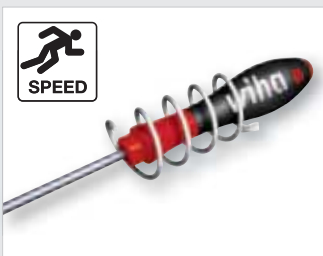

#### Quick-turning zone

- Safe, fast turning between the thumb and index finger
- Perfect guidance thanks to tapered handle end
- Long, slim handles
- Circular cross-section



#### Power turning zone

- Comfortable maximum power transmission
- All fingers can be placed on the handle
- No painful edges
- Large, octagonal cross-section

**Long lifespan:**  
Through hardened blade of chrome-vanadium-molybdenum steel

**Perfect fit in the screw head:**  
Precisely manufactured tip

**Durable corrosion protection:**  
Chromed surface

**Fast tip identification:**  
Cap imprint for tip and size

**No complaints even after intensive use, no pressure marks, calluses, or blisters:**  
Burr-free and offset-free

**Optimal material distribution:**  
The position of the soft and hard zones also supports the perfect grip for quick and powerful turning



**Optimal for scanning:**  
EAN code on each article

**Work safety:**  
Dual roll-off protection



# Wiha SoftFinish® range

Made in Germany.

Caps	SoftFinish	Blades	Drive
 		   	
 		   	
 		   	
 		   	

① round, ② round, insulated, ③ slimTECHNOLOGIE, ④ Hex, wrench



## Applications

	Standard
	Stubby
	Reversible blade system
	Torque
	Magazine bit holder
	Magazine bit holder Stubby
	Magazine bit holder LiftUp

# Wiha SoftFinish®.

The convenient expert for dry applications.



product  
design  
award

1997



*The right tool at a glance, thanks to the printed screw symbol on the handle end.*

The Wiha SoftFinish® zone features a solid moulded core with soft outer grip. This requires less force, yet achieves 40% more torque than conventional handles. The handle is shaped to fit comfortably in the hand, providing maximum through forces in dry working conditions.

If a stuck screw has to be loosened, a precise hammer blow can be applied to the solid steel cap. Due to the hex blade extending through the handle to the steel cap, there is no loss of impact energy.



*The solid steel cap at the end of the SoftFinish® handle enables controlled hammer blows, for example, when loosening a tight screw.*



*Due to the solid steel cap and hex blade extending through the handle, there is no loss of impact energy when a precise hammer blow is applied.*

*Blade with hex bolster for wrenches to use on particularly tight screws.*



## Wiha SoftFinish®.

- Multi-component SoftFinish® handle provides maximum user comfort
- Ergonomically perfect handle design
- Printed screw symbol on handle end for fast identification
- Available in versions with round blade, hex blade or hex blade with solid steel cap
- Blade made of high quality CVM-steel, through-hardened and chrome plated
- Wiha ChromTop®-finish on tip for a perfect fit every time

## For slotted screws.

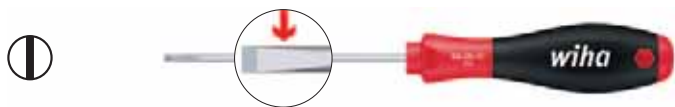
**302** SoftFinish® slotted cabinet screwdriver.**Round blade.**

Blade: High quality chrome-vanadium-molybdenum steel, through hardened, chrome-plated.  
Wiha ChromTop® finish on tip for a perfect fit every time.

Handle: Ergonomic Wiha SoftFinish® multi-component handle with roll-off protection.

Standards: DIN ISO 2380.

Application: Particularly suitable for dry applications.

Order-No.	⌀	↔	⊖	●	↔	↕	↔
00684	2.0•	65	0.4	2.0	169	23	10
00685	2.5	75	0.4	2.5	179	23	10
00686	3.0•	80	0.5	3.0	184	23	10
00687	3.0	100	0.5	3.0	204	23	10
00689	3.0•	150	0.5	3.0	254	23	10
00690	3.0•	200	0.5	3.0	304	23	10
32383	3.0	300	0.5	3.0	404	23	5
00691	3.5	100	0.6	3.5	204	23	10
26931	3.5•	200	0.6	3.5	304	23	10
00692	4.0	100	0.8	4.0	211	30	10
00694	4.0•	150	0.8	4.0	261	30	10
00695	4.0•	200	0.8	4.0	311	30	10
00696	4.0•	300	0.8	4.0	411	30	5
27753	4.5•	80	0.8	4.5	191	30	10
00697	4.5•	125	0.8	4.5	236	30	10
00698	5.5	125	1.0	5.5	236	30	10
00700	5.5	150	1.0	5.5	261	30	10
00701	5.5•	200	1.0	5.5	311	30	10
00702	5.5•	300	1.0	5.5	411	30	5
32384	6.0	300	1.0	6.0	418	36	5

• Additional dimension. Non-DIN size.

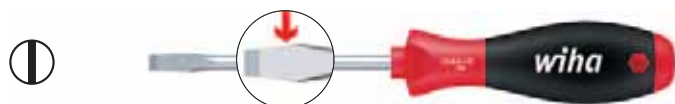
**302** SoftFinish® slotted workshop screwdriver.**Round blade.**

Blade: High quality chrome-vanadium-molybdenum steel, through hardened, chrome-plated.  
Wiha ChromTop® finish on tip for a perfect fit every time.

Handle: Ergonomic Wiha SoftFinish® multi-component handle with roll-off protection.

Standards: DIN ISO 2380.

Application: Particularly suitable for dry applications.

Order-No.	⌀	↔	⊖	●	↔	↕	↔
27754	6.0	100	1.0	5.5	218	36	10
27755	6.0	150	1.0	5.5	268	36	10
00704	6.5	100	1.2	6.0	218	36	10
00703	6.5	150	1.2	6.0	268	36	10
00706	6.5•	200	1.2	6.0	318	36	5
00708	8.0	150	1.2	7.0	274	41	10
00707	8.0	175	1.2	7.0	299	41	5
00709	8.0	175	1.6	7.0	299	41	5
32399	8.0	300	1.2	7.0	424	41	5
00711	10.0	200	1.6	8.0	324	41	5
32400	10.0	300	1.6	8.0	424	41	5
00712	12.0	250	2.0	8.0	374	41	5
00713	14.0	250	2.5	11.0	374	41	5

• Additional dimension. Non-DIN size.

## For slotted screws.

**308** SoftFinish® slotted screwdriver.**Hex blade with hex bolster.**

Blade: High quality chrome-vanadium-molybdenum steel, through hardened, chrome-plated.  
Wiha ChromTop® finish on tip for a perfect fit every time.

Handle: Ergonomic Wiha SoftFinish® multi-component handle with roll-off protection.

Standards: DIN 5265, ISO 2380.

Application: Particularly suitable for dry applications.

Order-No.	⌀	↔	⊖	●	⊖	↔	↕	↔
00731	3.5	75	0.6	4.0	-	186	30	10
00732	4.5•	90	0.8	4.0	-	201	30	10
00733	5.5	100	1.0	5.0	8	213	36	10
00734	6.5	125	1.2	6.0	10	238	36	10
00735	7.0•	125	1.1	6.0	10	238	36	10
00736	8.0	150	1.2	8.0	13	268	41	10
00737	9.0•	150	1.4	8.0	13	268	41	10
00738	10.0	175	1.6	8.0	13	293	41	5
00739	12.0	200	2.0	10.0	16	318	41	5
00740	14.0	250	2.5	10.0	16	368	41	5

• Additional dimension. Non-DIN size.

**530** SoftFinish® slotted screwdriver.**Hex blade with hex bolster, solid steel cap.**

Order-No.	⌀	↔	⊖	●	⊖	↔	↕	↔
03223	3.5	75	0.6	4.0	-	186	30	10
03224	4.5•	90	0.8	4.0	-	201	30	10
03225	5.5	100	1.0	5.0	8	213	36	10
03226	6.5	125	1.2	6.0	10	238	36	10
03228	8.0	150	1.2	8.0	13	271	41	5
03230	10.0	175	1.6	8.0	13	296	41	5
03231	12.0	200	2.0	10.0	16	321	41	5
03232	14.0	250	2.5	10.0	16	371	41	5

• Additional dimension. Non-DIN size.

**398** SoftFinish® slotted screw-holding screwdriver.**Clamping sleeve holds the screw.**

Blade: Chrome-vanadium steel, through hardened, black-finish.

Handle: Ergonomic Wiha SoftFinish® multi-component handle with roll-off protection.

Application: For setting and turning screws in difficult to access areas.

Order-No.	⌀	↔	⊖	↔	↕	↔
32867	2.5	75	0.4	186	30	5
32868	3.0	100	0.5	211	30	5
32869	4.0	125	0.8	243	36	5
32870	5.0	150	1.0	268	36	5
32871	6.0	175	1.2	293	36	5

# Wiha SoftFinish®.

The convenient expert for dry applications.

## For Phillips screws.



### 311 SoftFinish® Phillips screwdriver. Round blade.

Blade: High quality chrome-vanadium-molybdenum steel, through hardened, chrome-plated.  
Wiha ChromTop® finish on tip for a perfect fit every time.

Handle: Ergonomic Wiha SoftFinish® multi-component handle with roll-off protection.

Standards: DIN ISO 8764.

Application: Particularly suitable for dry applications.

Order-No.	⊕	↔	●	↔	↔	↔
00754	PH0	60	3.0	164	23	10
27756	PH0	100	3.0	204	23	10
00756	PH1	80	4.5	191	30	10
27757	PH1	100	4.5	211	30	10
00757	PH1•	200	4.5	311	30	10
03738	PH1•	300	4.5	411	30	5
00759	PH2	100	6.0	218	36	10
27758	PH2	150	6.0	268	36	10
00760	PH2•	200	6.0	318	36	5
03739	PH2•	300	6.0	418	36	5
00762	PH3	150	8.0	274	41	10
00763	PH4	200	10.0	324	41	5

• Additional dimension. Non-DIN size.



### 312 SoftFinish® Phillips screwdriver. Hex blade with hex bolster.

Order-No.	⊕	↔	⬡	⬡	↔	↔	↔
00764	PH1	80	5.0	8	186	30	10
00765	PH2	100	6.0	10	213	36	10
00766	PH3	150	8.0	13	268	41	10
00767	PH4	200	10.0	16	318	41	5



### 531 SoftFinish® Phillips screwdriver. Hex blade with hex bolster, solid steel cap.

Order-No.	⊕	↔	⬡	⬡	↔	↔	↔
03237	PH1	80	5.0	8	186	30	10
03238	PH2	100	6.0	10	213	36	10
03239	PH3	150	8.0	13	268	41	10



### 397 SoftFinish® Phillips screw-holding screwdriver. Clamping sleeve holds the screw.

Blade: Chrome-vanadium steel, through hardened, black-finish.

Handle: Ergonomic Wiha SoftFinish® multi-component handle with roll-off protection.

Application: For setting and turning screws in difficult to access areas.

Order-No.	⊕	↔	↔	↔	↔
32406	PH0	100	211	30	5
32404	PH1	125	236	36	5
32405	PH2	175	286	36	5

## For Pozidriv screws.



### 313 SoftFinish® Pozidriv screwdriver. Round blade.

Blade: High quality chrome-vanadium-molybdenum steel, through hardened, chrome-plated.  
Wiha ChromTop® finish on tip for a perfect fit every time.

Handle: Ergonomic Wiha SoftFinish® multi-component handle with roll-off protection.

Standards: DIN ISO 8764.

Application: Particularly suitable for dry applications.

Order-No.	⊕	↔	●	↔	↔	↔
00768	PZ0	60	3.0	164	23	10
00770	PZ1	80	4.5	191	30	10
26454	PZ1	300	4.5	411	30	5
00772	PZ2	100	6.0	218	36	10
26455	PZ2	300	6.0	418	36	5
00774	PZ3	150	8.0	274	41	10



### 314 SoftFinish® Pozidriv screwdriver. Hex blade with hex bolster.

Blade: High quality chrome-vanadium-molybdenum steel, through hardened, chrome-plated.  
Wiha ChromTop® finish on tip for a perfect fit every time.

Handle: Ergonomic Wiha SoftFinish® multi-component handle with roll-off protection.

Standards: DIN ISO 8764.

Application: Particularly suitable for dry applications.

Order-No.	⊕	↔	⬡	⬡	↔	↔	↔
00776	PZ1	80	5.0	8	186	30	10
00777	PZ2	100	6.0	10	213	36	10
00778	PZ3	150	8.0	13	268	41	10
00779	PZ4	200	10.0	16	318	41	5



### 532 SoftFinish® Pozidriv screwdriver. Hex blade with hex bolster, solid steel cap.

Blade: High quality chrome-vanadium-molybdenum steel, through hardened, chrome-plated.  
Wiha ChromTop® finish on tip for a perfect fit every time.

Handle: Ergonomic Wiha SoftFinish® multi-component handle with roll-off protection.

Standards: DIN ISO 8764.

Application: Particularly suitable for dry applications.

Order-No.	⊕	↔	⬡	⬡	↔	↔	↔
03245	PZ1	80	5.0	8	186	30	10
03246	PZ2	100	6.0	10	213	36	10
03247	PZ3	150	8.0	13	268	41	10



**Screwdriver with mm scale.**



**3021 SoftFinish® slotted screwdriver.**

**Round blade with lasered mm scale.**

Blade: High quality chrome-vanadium-molybdenum steel, through hardened, chrome-plated.  
 Wiha ChromTop® finish on tip for a perfect fit every time.

Handle: Ergonomic Wiha SoftFinish® multi-component handle with roll-off protection.

Standards: DIN ISO 2380.

Application: Particularly suitable for dry applications.

Extra: High-contrast millimetre scale permanently lasered on to the blade for depth, inner, outer and step measurements.

Order-No.	⌀	↔	⊖	●	↔	↔	Scale	↔
36085	4.0	100	0.8	4.0	211	30	20-90	10
35397	5.5	125	1.0	5.5	236	30	30-110	10



**3111 SoftFinish® Phillips screwdriver.**

**Round blade with lasered mm scale.**

Blade: High quality chrome-vanadium-molybdenum steel, through hardened, chrome-plated.  
 Wiha ChromTop® finish on tip for a perfect fit every time.

Handle: Ergonomic Wiha SoftFinish® multi-component handle with roll-off protection.

Standards: DIN ISO 8764.

Application: Particularly suitable for dry applications.

Extra: High-contrast millimetre scale permanently lasered on to the blade for depth, inner, outer and step measurements.

Order-No.	⊕	↔	●	↔	↔	Scale	↔
36072	PH1	80	4.5	191	30	20-70	10
35398	PH2	100	6.0	218	36	20-90	10



**3131 SoftFinish® Pozidriv screwdriver.**

**Round blade with lasered mm scale.**

Blade: High quality chrome-vanadium-molybdenum steel, through hardened, chrome-plated.  
 Wiha ChromTop® finish on tip for a perfect fit every time.

Handle: Ergonomic Wiha SoftFinish® multi-component handle with roll-off protection.

Standards: DIN ISO 8764.

Application: Particularly suitable for dry applications.

Extra: High-contrast millimetre scale permanently lasered on to the blade for depth, inner, outer and step measurements.

Order-No.	⊕	↔	●	↔	↔	Scale	↔
36073	PZ1	80	4.5	191	30	20-70	10
35399	PZ2	100	6.0	218	36	20-90	10

**Screwdriver with mm scale.**



**SB 3021 S2 SoftFinish® slotted/ Phillips screwdriver set, 2-pcs.**  
**Round blade with lasered mm scale.**  
**Blister packed.**

Order-No.	Series	↔
36205	SB 3021 S2	1
⌀	3021	5.5x125
⊕	3111	PH2x100



**3021 VB Display SoftFinish® with scale.**  
**Card display with 18 pcs.**

Size: 28 x 13 x 36 cm (WxDxH).

Order-No.	Series	↔
35555	3021 VB	1
⌀	3021	6x5.5
⊕	3111	6xPH2
⊕	3131	6xPZ2

# Wiha SoftFinish®.

The convenient expert for dry applications.

## Stubby-screwdriver.



### 302 SoftFinish® slotted screwdriver. Short round blade.

Blade: High quality chrome-vanadium-molybdenum steel, through hardened, chrome-plated.

Wiha ChromTop® finish on tip for a perfect fit every time.

Handle: Ergonomic Wiha Stubby SoftFinish® handle, multi-component with roll-off protection.

Standards: DIN 5265, ISO 2380, handle based on DIN 5268 - style K.

Application: For working in confined spaces.

Order-No.	⌀	↔	⊖	●	↔	↔	↔
26964	4.0	25	0.8	4.0	81	34	10
26965	5.5	25	1.0	5.5	81	34	10
26966	6.5	25	1.2	6.5	81	34	10
26967	8.0	25	1.2	8.0	81	34	10



### 311 SoftFinish® Phillips screwdriver. Short round blade.

Blade: High quality chrome-vanadium-molybdenum steel, through hardened, chrome-plated.

Wiha ChromTop® finish on tip for a perfect fit every time.

Handle: Ergonomic Wiha Stubby SoftFinish® handle, multi-component with roll-off protection.

Standards: DIN ISO 8764, handle based on DIN 5268 - style K.

Application: For working in confined spaces.

Order-No.	⊕	↔	●	↔	↔	↔
26968	PH1	25	4.5	81	34	10
26969	PH2	25	6.0	81	34	10
26970	PH3	25	8.0	81	34	10



### 313 SoftFinish® Pozidriv screwdriver. Short round blade.

Blade: High quality chrome-vanadium-molybdenum steel, through hardened, chrome-plated.

Wiha ChromTop® finish on tip for a perfect fit every time.

Handle: Ergonomic Wiha Stubby SoftFinish® handle, multi-component with roll-off protection.

Standards: DIN ISO 8764, handle based on DIN 5268 - style K.

Application: For working in confined spaces.

Order-No.	⊕	↔	●	↔	↔	↔
26971	PZ1	25	4.5	81	34	10
26972	PZ2	25	6.0	81	34	10
26973	PZ3	25	8.0	81	34	10

## For TORX® screws.



### 362 SoftFinish® TORX® screwdriver. Round blade.

Blade: High quality chrome-vanadium-molybdenum steel, through hardened, chrome-plated.

Wiha ChromTop® finish on tip for a perfect fit every time.

Handle: Ergonomic Wiha SoftFinish® multi-component handle with roll-off protection.

Application: Particularly suitable for dry applications.

Order-No.	⊗	↔	●	↔	↔	↔
26259	T3	60	2.5	164	23	10
26260	T4	60	2.5	164	23	10
01285	T5	60	2.5	164	23	10
01286	T6	60	3.5	164	23	10
01287	T7	60	3.5	164	23	10
01288	T8	60	3.5	164	23	10
01289	T9	60	4.0	171	30	10
01290	T10	80	4.0	191	30	10
01291	T15	80	4.0	191	30	10
01292	T20	100	4.0	218	36	10
01293	T25	100	4.5	218	36	10
01294	T27	115	5.5	233	36	10
01295	T30	115	6.0	233	36	10
01296	T40	130	7.0	254	41	10
01297	T45	130	8.0	254	41	5



### 362BE SoftFinish® TORX® ball end screwdriver. Hex blade.

Blade: High-quality chrome-molybdenum steel, through-hardened, chrome-plated.

Wiha ChromTop® finish on tip for a perfect fit every time.

Handle: Ergonomic Wiha SoftFinish® multi-component handle with roll-off protection.

Application: For all hard-to-reach TORX® screws.

Extra: The TORX® ball end enables fastening and unfastening at an angle of up to 25°.

With elongated TORX® profile behind ball end.

Order-No.	⊗	↔	●	●	↔	↔	↔
32250	T9	60	7/64	2.8	164	23	10
32251	T10	60	1/8	3.2	184	23	10
32252	T15	80	9/64	3.6	191	30	10
32253	T20	80	5/32	4.0	211	30	10
32254	T25	100	3/16	4.8	218	36	10
32255	T27	115	7/32	5.6	233	36	10
32256	T30	115	1/4	6.4	233	36	10

## For TORX® and TORX® tamper resistant screws.

**362R** SoftFinish® TORX® MagicSpring® screwdriver.  
Retaining spring holds TORX® screws in place.

Blade: High quality chrome-vanadium-molybdenum steel, through hardened, chrome-plated.

Wiha ChromTop® finish on tip for a perfect fit every time.

Handle: Ergonomic Wiha SoftFinish® multi-component handle with roll-off protection.

Application: For setting and tightening TORX® screws in difficult to access areas.

Order-No.	⊕	↔	●	↔	↔	↔
27736	T6	60	3.5	164	23	10
27737	T7	60	3.5	164	23	10
27738	T8	60	3.5	164	23	10
27739	T9	60	4.0	171	30	10
27740	T10	80	4.0	191	30	10
27741	T15	80	4.0	191	30	10
27742	T20	100	4.0	218	36	10
27743	T25	100	4.5	218	36	10
27811	T27	115	5.5	233	36	10
27744	T30	115	6.0	233	36	10
27745	T40	130	7.0	254	41	10

## For TORX PLUS® screws.

**362IP** SoftFinish® TORX PLUS® screwdriver.  
Round blade.

Blade: High quality chrome-vanadium-molybdenum steel, through hardened, chrome-plated.

Wiha ChromTop® finish on tip for a perfect fit every time.

Handle: Ergonomic Wiha SoftFinish® multi-component handle with roll-off protection.

Application: Particularly suitable for dry applications.

Extra: The stronger profile of the TORX PLUS® tip allows up to 25% extra torque than the TORX® profile.

Order-No.	⊕	↔	●	↔	↔	↔
26091	6IP	60	3.5	164	23	10
26093	7IP	60	3.5	164	23	10
26095	8IP	60	3.5	164	23	10
26097	9IP	60	4.0	171	30	10
26099	10IP	80	4.0	191	30	10
26101	15IP	80	4.0	191	30	10
26103	20IP	100	4.0	218	36	10
26105	25IP	100	4.5	218	36	10
26107	27IP	115	5.5	233	36	10
26109	30IP	115	6.0	233	36	10
26111	40IP	130	7.0	254	41	10

**362TR** SoftFinish® TORX® Tamper Resistant screwdriver.  
With borehole in the blade tip.  
For TORX® screws with locking pin.

Blade: High quality chrome-vanadium-molybdenum steel, through hardened, chrome-plated.

Wiha ChromTop® finish on tip for a perfect fit every time.

With borehole in the blade tip.

Handle: Ergonomic Wiha SoftFinish® multi-component handle with roll-off protection.

Order-No.	⊕	↔	●	↔	↔	↔
03106	T7H	60	3.5	164	23	10
03107	T8H	60	3.5	164	23	10
03108	T9H	60	4.0	171	30	10
26456	T9H	300	4.0	411	30	5
01300	T10H	80	4.0	191	30	10
26457	T10H	300	4.0	411	30	5
01301	T15H	80	4.0	191	30	10
26458	T15H	300	5.0	411	30	5
01302	T20H	100	4.0	211	30	10
28005	T20H	300	5.0	411	30	5
01303	T25H	100	4.5	211	30	10
01304	T27H	115	5.5	233	36	10
01305	T30H	115	6.0	233	36	10
01306	T40H	130	7.0	254	41	10

**362RIP** SoftFinish® TORX PLUS® MagicSpring® screwdriver.  
Retaining spring holds TORX PLUS® screws in place.

Blade: High quality chrome-vanadium-molybdenum steel, through hardened, chrome-plated.

Wiha ChromTop® finish on tip for a perfect fit every time.

Handle: Ergonomic Wiha SoftFinish® multi-component handle with roll-off protection.

Application: For setting and tightening TORX PLUS® screws in hard to reach areas.

Extra: The stronger profile of the TORX PLUS® tip allows up to 25% extra torque than the TORX® profile.

Order-No.	⊕	↔	●	↔	↔	↔
28760	6IP	60	3.5	164	23	10
28761	7IP	60	3.5	164	23	10
28762	8IP	60	3.5	164	23	10
28763	9IP	60	4.0	171	30	10
28764	10IP	80	4.0	191	30	10
28765	15IP	80	4.0	191	30	10
28766	20IP	100	4.0	218	36	10
28767	25IP	100	4.5	218	36	10
28768	27IP	115	5.5	233	36	10
28769	30IP	115	6.0	233	36	10
28770	40IP	130	7.0	254	41	10

# Wiha SoftFinish®.

The convenient expert for dry applications.

## For hex socket screws.



**367** SoftFinish® ball end hex screwdriver.  
Hex blade.

Blade: Chrome-vanadium steel, through hardened, chrome-plated.  
Handle: Ergonomic Wiha SoftFinish® multi-component handle with roll-off protection.  
Application: For all screws that are difficult to access.  
Extra: The ball end enables the user to work at angles up to 25°.

Order-No.	●	↔	↔	↕	↔
26303	1.5	75	179	23	10
26304	2	100	204	23	10
26305	2.5	100	204	23	10
26328	3	100	204	23	10
26329	4	100	211	30	10
26330	5	100	211	30	10
26331	6	125	243	36	10
26332	8	150	268	36	10
26333	10	150	271	41	5
26307	12	150	271	41	5

## For hex and slotted screws.



**357** SoftFinish® offset hex screwdriver.  
Hex blade.

Blade: Chrome-vanadium steel, through hardened, chrome-plated.  
Handle: Ergonomic Wiha SoftFinish® multi-component handle with roll-off protection.  
Application: Ideal for high-torque applications, e.g. in workshops.

Order-No.	●	↔	↔	↕	↔	
26230	3	35	20	139	23	10
26231	4	40	25	151	30	10
26232	5	45	28	156	30	10
26233	6	50	32	168	36	10
26234	8	60	36	178	36	10
26235	10	75	40	199	41	10



**367R** SoftFinish® MagicRing® ball end hex screwdriver.  
Ring made of spring steel holds hex screws in place.

Blade: Chrome-vanadium steel, through hardened, chrome-plated.  
Handle: Ergonomic Wiha SoftFinish® multi-component handle with roll-off protection.  
Application: For setting and turning screws in difficult to access areas.  
Extra: The ball end enables the user to work at angles up to 25°.

Order-No.	●	↔	↔	↕	↔
26077	3	100	204	23	10
26079	4	100	211	30	10
26081	5	100	211	30	10
26083	6	125	243	36	10
26085	8	150	268	36	10
26087	10	150	271	41	5



**305** SoftFinish® slotted nut driver.  
Round blade.

Blade: Chrome-vanadium steel, through hardened, chrome-plated.  
Handle: Ergonomic Wiha SoftFinish® multi-component handle with roll-off protection.  
Standards: DIN 3125.  
Application: For nuts DIN 546.

Order-No.	⊙	↔	⊙	⊙	↔	↕	↔
32364	M1.7	80	0.5	4.0	184	23	5
32363	M2	80	1.0	4.5	184	23	5
32362	M2.3	90	1.0	5.0	201	30	5
32361	M2.6	90	1.2	5.5	201	30	5
32360	M3	100	1.2	6.0	211	30	5
32358	M3.5	100	1.4	7.0	218	36	5
32359	M4	100	1.4	8.0	218	36	5
32357	M5	125	2.0	10.0	243	36	5
32356	M6	125	2.5	11.0	243	36	5
32355	M8	150	3.0	14.0	274	41	5
32354	M10	150	3.5	18.0	274	41	5



**356** SoftFinish® hex screwdriver.  
Hex blade.

Blade: Chrome-vanadium steel, through hardened, chrome-plated.  
Handle: Ergonomic Wiha SoftFinish® multi-component handle with roll-off protection.

Order-No.	●	↔	↔	↕	↔
32264	1.5	60	164	23	10
32265	2.0	60	164	23	10
26190	2.5	75	179	23	10
26191	3	75	179	23	10
26192	4	75	186	30	10
26193	5	75	186	30	10
26194	6	100	218	36	10
26195	8	100	218	36	10

## Wiha Info



**Wiha MagicRing®:**  
spring steel ring  
reliably holds hex screws  
in place.



**For hex nuts.**



**341** SoftFinish® hex nut driver.

**Round blade.**

Blade: Chrome-vanadium steel, through hardened, chrome-plated.  
Deep drawn socket.  
Handle: Ergonomic Wiha SoftFinish® multi-component handle with roll-off protection.  
Standards: DIN 3125.  
Application: Particularly suitable for dry applications.

Order-No.	Ø	↔	↔	↕	⊥	⊥
01018	4	125	236	30	6.9	10
01020	5	125	236	30	7.9	10
01021	5.5	125	236	30	7.9	10
01022	6	125	236	30	8.9	10
01023	7	125	243	36	10.9	10
01024	8	125	243	36	11.9	10
01025	9	125	243	36	12.9	10
01026	10	125	243	36	14.4	10
01027	11	125	249	41	15.9	5
01028	12	125	249	41	16.9	5
01029	13	125	249	41	18.4	5
01030	14	125	249	41	19.4	5
01031	15	125	249	41	21.9	5
01032	16	125	249	41	21.9	5
01033	17	125	249	41	23.4	5



**347** SoftFinish® hex nut driver.

**Round blade with hex bolster.**

Blade: Chrome-vanadium steel, through hardened, chrome-plated.  
Deep drawn socket.  
Handle: Ergonomic Wiha SoftFinish® multi-component handle with roll-off protection.  
Standards: DIN 3125.  
Application: Particularly suitable for dry applications.

Order-No.	Ø	↔	⊠	↔	↕	⊥	⊥
01092	7	125	10	238	36	11.0	10
01093	8	125	10	238	36	12.0	10
01094	9	125	10	238	36	13.0	10
01095	10	125	10	238	36	14.5	10
01096	11	125	13	246	41	16.0	5
01097	12	125	13	246	41	17.0	5
01098	13	125	13	246	41	19.0	5

**347 Zoll** SoftFinish® hex nut driver. Inch sizes.

**Round blade with hex bolster.**

Blade: Chrome-vanadium steel, through hardened, nickel-plated.  
Deep drawn socket.  
Handle: Ergonomic Wiha SoftFinish® multi-component handle with roll-off protection.  
Application: Particularly suitable for dry applications.

Order-No.	Ø	↔	⊠	↔	↕	mm	⊥	⊥
02836	3/16	125	10	231	30	4.76	8	10
02837	1/4	125	10	238	36	6.35	10	10
02838	5/16	125	10	238	36	7.94	12	10
02839	3/8	125	10	238	36	9.53	14	10
02840	7/16	125	13	246	41	11.11	16	10
02841	1/2	125	13	246	41	12.70	19	10

**For hex and triangular nuts.**



**343** SoftFinish® hex nut driver.

**Short round blade.**

Blade: Chrome-vanadium steel, through hardened, chrome-plated.  
Deep drawn socket.  
Handle: Ergonomic Wiha SoftFinish® multi-component handle with roll-off protection.  
Application: For working in confined spaces.

Order-No.	Ø	↔	↔	↕	⊥	⊥
01076	5.5	65	176	30	8	10
01077	6	65	176	30	9	10
01078	7	65	183	36	11	10
01079	8	65	183	36	12	10
01081	10	65	183	36	14	10



**372** SoftFinish® hex nut driver.

**Flexible shaft for hard to reach areas.**

Handle: Ergonomic Wiha SoftFinish® multi-component handle with roll-off protection.  
Application: E.g. for tightening and loosening adjustable hose clamps.

Order-No.	Ø	↔	↔	↕	⊥	⊥
01435	5	150	261	30	8	10
01436	5.5	150	261	30	8	10
01437	6	150	261	30	9	10
01438	7	150	268	36	11	10
01439	8	150	268	36	12	10
01440	10	175	293	41	14	10
01443	13	175	293	41	19	5



**344** SoftFinish® triangular nut driver.

**Round blade.**

Blade: Chrome-vanadium steel, through hardened, chrome-plated.  
Handle: Ergonomic Wiha SoftFinish® multi-component handle with roll-off protection.  
Standards: DIN 22416.  
Application: For triangular screws DIN 22424 and triangular nuts DIN 22425.

Order-No.	Ø	↔	↔	↕	⊥	⊥	
26212	M4	125	6.8	236	30	11	10
26213	M5	125	8.3	236	30	13	10
26216	M6	125	10.05	236	30	16	10
26214	M8	125	12.05	243	36	18	10
26217	M10	125	15.05	243	36	22	10
26218	M12	125	16.55	249	41	24	10

# Wiha SoftFinish®.

The convenient expert for dry applications.

## Sets with round blades.



**302 HK6 SO** SoftFinish® slotted/ Phillips screwdriver set, 6 pcs.  
Round blades.

Blade: High quality chrome-vanadium-molybdenum steel, through hardened, chrome-plated.  
Wiha ChromTop® finish on tip for a perfect fit every time.

Handle: Ergonomic Wiha SoftFinish® multi-component handle with roll-off protection.

Application: Particularly suitable for dry applications.

Order-No.	Series					
07152	302 HK6 SO					1
⓪	302	3.5x100	4.5x125	5.5x150	6.5x150	
⊕	311	PH1x80	PH2x100			

## Sets with round blades.



**302 HK6 01** SoftFinish® slotted/ Phillips/ Pozidriv screwdriver set, 6 pcs.  
Round blades.

Blade: High quality chrome-vanadium-molybdenum steel, through hardened, chrome-plated.  
Wiha ChromTop® finish on tip for a perfect fit every time.

Handle: Ergonomic Wiha SoftFinish® multi-component handle with roll-off protection.

Application: Particularly suitable for dry applications.

Order-No.	Series				
26113	302 HK6 01				1
⓪	302	4.0x100	5.5x125	6.5x150	
⊕	311	PH1x80	PH2x100		
⊕	313	PZ2x100			



**302 ZK6 SO** SoftFinish® slotted/ Pozidriv screwdriver set, 6 pcs.  
Round blades.

Order-No.	Series					
07153	302 ZK6 SO					1
⓪	302	3.5x100	4.5x125	5.5x150	6.5x150	
⊕	313	PZ1x80	PZ2x100			



**311 K6** SoftFinish® Phillips/Pozidriv screwdriver set, 6 pcs.  
Round blades.

Blade: High quality chrome-vanadium-molybdenum steel, through hardened, chrome-plated.  
Wiha ChromTop® finish on tip for a perfect fit every time.

Handle: Ergonomic Wiha SoftFinish® multi-component handle with roll-off protection.

Application: Particularly suitable for dry applications.

Order-No.	Series				
26146	311 K6				1
⊕	311	PH1x80	PH2x100	PH3x150	
⊕	313	PZ1x80	PZ2x100	PZ3x150	

Sets with hex blades.

Sets with steel caps.



**308 HK6** SoftFinish® slotted/ Phillips screwdriver set, 6 pcs.  
Hex blades with hex bolster.

**530 HK6** SoftFinish® slotted/ Phillips screwdriver set, 6 pcs.  
Hex blades with hex bolster, solid steel cap.

Blade: High quality chrome-vanadium-molybdenum steel, through hardened, chrome-plated.  
Wiha ChromTop® finish on tip for a perfect fit every time.

Handle: Ergonomic Wiha SoftFinish® multi-component handle with roll-off protection.

Application: Particularly suitable for dry applications.

Blade: High quality chrome-vanadium-molybdenum steel, through hardened, chrome-plated.  
Wiha ChromTop® finish on tip for a perfect fit every time.

Handle: Ergonomic Wiha SoftFinish® multi-component handle with roll-off protection.

Application: Particularly suitable for dry applications.

Order-No.	Series					
21248	308 HK6					1
⓪	308	3.5x75	4.5x90	5.5x100	7.0x125	
⊕	312	PH1x80	PH2x100			

Order-No.	Series					
21250	530 HK6					1
⓪	530	3.5x75	4.5x90	5.5x100	6.5x125	
⊕	531	PH1x80	PH2x100			



**308 ZK6** SoftFinish® slotted/ Pozidriv screwdriver set, 6 pcs.  
Hex blades with hex bolster.

**530 ZK6** SoftFinish® slotted/ Pozidriv screwdriver set, 6 pcs.  
Hex blades with hex bolster, solid steel cap.

Order-No.	Series					
21249	308 ZK6					1
⓪	308	3.5x75	4.5x90	5.5x100	7.0x125	
⊕	314	PZ1x80	PZ2x100			

Order-No.	Series					
21251	530 ZK6					1
⓪	530	3.5x75	4.5x90	5.5x100	6.5x125	
⊕	532	PZ1x80	PZ2x100			

# Wiha SoftFinish®.

The convenient expert for dry applications.

## TORX® sets.



### 362 K6 SO SoftFinish® TORX® screwdriver set, 6 pcs. Round blades.

- Blade: High quality chrome-vanadium-molybdenum steel, through hardened, chrome-plated. Wiha ChromTop® finish on tip for a perfect fit every time.
- Handle: Ergonomic Wiha SoftFinish® multi-component handle with roll-off protection.
- Application: Particularly suitable for dry applications.

Order-No.	Series				
07155	362 K6 SO	1			
☛	362	T10x80	T15x80	T20x100	T25x100
		T30x115	T40x130		

## TORX® sets.



### 362BE K6 SoftFinish® TORX® ball end screwdriver set, 6 pcs. Hex blade.

- Blade: High-quality chrome-vanadium-molybdenum steel, through-hardened, chrome-plated. Wiha ChromTop® finish on tip for a perfect fit every time.
- Handle: Ergonomic Wiha SoftFinish® multi-component handle with roll-off protection.
- Application: For all hard-to-reach TORX® screws.
- Extra: The TORX® ball end enables fastening and unfastening at an angle of up to 25°. With elongated TORX® profile behind ball end.

Order-No.	Series				
32249	362BE K6	1			
☛	362BE	T9x60	T10x60	T15x80	T20x80
		T25x100	T30x115		



### 362 K7 SoftFinish® TORX® screwdriver set, 7 pcs. Round blades.

- Blade: High quality chrome-vanadium-molybdenum steel, through hardened, chrome-plated. Wiha ChromTop® finish on tip for a perfect fit every time.
- Handle: Ergonomic Wiha SoftFinish® multi-component handle with roll-off protection.
- Application: Particularly suitable for dry applications.

Order-No.	Series				
01299	362 K7	1			
☛	362	T8x60	T9x60	T10x80	T15x80
		T20x100	T25x100	T30x115	



### 362R K6 SO SoftFinish® TORX® MagicSpring® screwdriver set, 6 pcs. Retaining spring holds TORX® screws in place.

- Blade: High quality chrome-vanadium-molybdenum steel, through hardened, chrome-plated. Wiha ChromTop® finish on tip for a perfect fit every time.
- Handle: Ergonomic Wiha SoftFinish® multi-component handle with roll-off protection.
- Application: For setting and tightening TORX® screws in difficult to access areas.

Order-No.	Series				
27746	362R K6 SO	1			
☛	362R	T10x80	T15x80	T20x100	T25x100
		T30x115	T40x130		

**TORX® tamper-resistant set.**

**Nut driver set.**



**362TR K6** SoftFinish® TORX® Tamper Resistant screwdriver set, 6 pcs.  
For TORX® screws with locking pin.

**341 K5** SoftFinish® hex nut driver set, 5 pcs.  
Round blades.

Blade: High quality chrome-vanadium-molybdenum steel, through hardened, chrome-plated.  
Wiha ChromTop® finish on tip for a perfect fit every time.  
With borehole in the blade tip.

Handle: Ergonomic Wiha SoftFinish® multi-component handle with roll-off protection.

Application: For turning TORX® Tamper Resistant safety screws.

Blade: Chrome-vanadium steel, through hardened, chrome-plated. Deep drawn socket.

Handle: Ergonomic Wiha SoftFinish® multi-component handle with roll-off protection.

Application: Particularly suitable for dry applications.

Order-No.	Series				
24506	362TR K6	1			
	362TR	T10Hx80	T15Hx80	T20Hx100	T25Hx100
		T30Hx115	T40Hx130		

Order-No.	Series				
01034	341 K5	1			
	341	5.5x125	7x125	8x125	10x125
		13x125			



**Wiha TORX® MagicSpring®.**  
Because of the "MagicSpring®" retaining spring made of stainless steel, TORX® screws are held securely in place. An innovation, which will convince each user.



# Wiha MicroFinish.

The specialist for wet and oily applications.



Non-slip



The non-slip handle is made from cellulose acetate and has a micro-fine surface structure. This gives maximum torque transmission and perfect handling in wet and oily work surroundings.

Optimum power transfer, even with very oily hands! Wiha MicroFinish screwdrivers stand for contemporary handle design, together with the ideal combination of materials for wet and oily applications.

The micro-fine surface of the finish zone made of sandblasted cellulose-acetate ensures maximum power transfer and provides an effective non-slip grip, even with very oily hands. The roll-off protection in the front area of the handle prevents the tool from rolling off the workbench. The screwdriver is also available with a solid steel cap for loosening tight screws with a single hammer blow. As the steel cap is connected to the blade, the entire energy from the impact is transmitted to the screw head without damaging either the handle or the blade.

The MicroFinish hex blades



with ChromTop® tip are made of highquality chrome-vanadium-molybdenum steel, are through-hardened and chrome-plated. This guarantees a particularly long tool life.

Wiha's MicroFinish screwdrivers are ideal for automotive applications, for use on building sites or when working with sanitary installations. However, they can also be used to perform repairs to machinery and equipment where oil and lubricants pose potential problems.

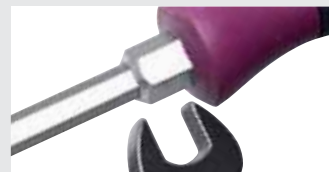

The hex blade and hex bolster model with solid steel cap is ideal for loosening tight screws.



## Wiha MicroFinish.

- Micro-fine handle surface for a non-slip grip in an oily working environment
- Ergonomic handle shape fits every hand
- Blades made of high-quality chrome-vanadium-steel, through-hardened and chrome-plated for a long tool life
- Wiha ChromTop® blade tip sits securely in the screw head and offers great dimensional accuracy

**For slotted screws.**



**5520** MicroFinish slotted screwdriver.  
**Round blade.**

Blade: High quality chrome-vanadium-molybdenum steel, through hardened, chrome-plated.  
Wiha ChromTop® finish on tip for a perfect fit every time.  
Handle: Non-slip Wiha MicroFinish handle with roll-off protection.  
Standards: DIN 5265, ISO 2380.  
Application: Best suited for turning screws in wet and oily applications.

Order-No.	⌀	↔	⊖	●	↔	↔	↔
29115	3.5	100	0.6	3.5	204	23	10
29116	4.0	100	0.8	4.0	211	30	10
29117	4.0•	150	0.8	4.0	261	30	10
29118	5.5	125	1.0	5.5	236	30	10
29119	5.5	150	1.0	5.5	261	30	10
29120	6.5	150	1.2	6.0	268	36	10
29121	8.0	150	1.2	7.0	274	41	10
29122	8.0	175	1.2	7.0	299	41	10
29123	10.0	200	1.6	8.0	324	41	5

• Additional dimension. Non-DIN size.



**5533** MicroFinish slotted screwdriver.  
**Hex blade with hex bolster, solid steel cap.**

Blade: High quality chrome-vanadium-molybdenum steel, through hardened, chrome-plated.  
Wiha ChromTop® finish on tip for a perfect fit every time.  
Handle: Non-slip Wiha MicroFinish handle with roll-off protection.  
Standards: DIN 5265, ISO 2380.  
Application: Best suited for turning screws in wet and oily applications.

Order-No.	⌀	↔	⊖	●	⊖	↔	↔	↔
29133	4.5•	90	0.8	4.0	-	201	30	10
29134	5.5	100	1.0	5.0	8	213	36	10
29135	6.5	125	1.2	6.0	10	238	36	10
29136	8.0	150	1.2	8.0	13	271	41	5
29137	10.0	175	1.6	8.0	13	296	41	5

• Additional dimension. Non-DIN size.

**For Phillips screws.**



**5521** MicroFinish Phillips screwdriver.  
**Round blade.**

Blade: High quality chrome-vanadium-molybdenum steel, through hardened, chrome-plated.  
Wiha ChromTop® finish on tip for a perfect fit every time.  
Handle: Non-slip Wiha MicroFinish handle with roll-off protection.  
Standards: DIN ISO 8764.  
Application: Best suited for turning screws in wet and oily applications.

Order-No.	⊕	↔	●	↔	↔	↔
29140	PH0	60	3.0	165	23	10
29141	PH1	80	4.5	192	30	10
29142	PH1•	200	4.5	312	30	5
29143	PH2	100	6.0	220	36	10
29144	PH2•	200	6.0	320	36	5
29145	PH3	150	8.0	277	41	10

• Additional dimension. Non-DIN size.



**5534** MicroFinish Phillips screwdriver.  
**Hex blade with hex bolster, solid steel cap.**

Blade: High quality chrome-vanadium-molybdenum steel, through hardened, chrome-plated.  
Wiha ChromTop® finish on tip for a perfect fit every time.  
Handle: Non-slip Wiha MicroFinish handle with roll-off protection.  
Standards: DIN ISO 8764.  
Application: Best suited for turning screws in wet and oily applications.

Order-No.	⊕	↔	●	⊖	↔	↔	↔
29149	PH1	80	5.0	8	187	30	10
29150	PH2	100	6.0	10	214	36	10
29151	PH3	150	8.0	13	271	41	10

**Wiha Info**



**Wiha MicroFinish®.**

Due to the sandblasted surface, oil and moisture flow away from the handle surface for a powerful, non-slip grip – a maximum force and comfort with dry, oily or wet hands is ensured.

The ergonomic handle shape ensures also exceptional torque transfer.

# Wiha MicroFinish®.

The specialist for wet and oily applications.

## For Pozidriv and TORX® screws.



### 5522 MicroFinish Pozidriv screwdriver. Round blade.

Blade: High quality chrome-vanadium-molybdenum steel, through hardened, chrome-plated.  
Wiha ChromTop® finish on tip for a perfect fit every time.  
Handle: Non-slip Wiha MicroFinish handle with roll-off protection.  
Standards: DIN ISO 8764.  
Application: Best suited for turning screws in wet and oily applications.

Order-No.	⊕	↔	●	↔	+	↔
29152	PZ1	80	4.5	192	30	10
29153	PZ2	100	6.0	220	36	10
29154	PZ3	150	8.0	277	41	10



### 5535 MicroFinish Pozidriv screwdriver. Hex blade with hex bolster, solid steel cap.

Blade: High quality chrome-vanadium-molybdenum steel, through hardened, chrome-plated.  
Wiha ChromTop® finish on tip for a perfect fit every time.  
Handle: Non-slip Wiha MicroFinish handle with roll-off protection.  
Standards: DIN ISO 8764.  
Application: Best suited for turning screws in wet and oily applications.

Order-No.	⊕	↔	⬡	⬡	↔	+	↔
29158	PZ1	80	5.0	8	187	30	10
29159	PZ2	100	6.0	10	214	36	10
29160	PZ3	150	8.0	13	271	41	5



### 5527 MicroFinish TORX® screwdriver. Round blade.

Blade: High quality chrome-vanadium-molybdenum steel, through hardened, chrome-plated.  
Wiha ChromTop® finish on tip for a perfect fit every time.  
Handle: Non-slip Wiha MicroFinish handle with roll-off protection.  
Application: Best suited for turning screws in wet and oily applications.

Order-No.	⊕	↔	●	↔	+	↔
29161	T9	60	4.0	172	30	10
29162	T10	80	4.0	192	30	10
29163	T15	80	4.0	192	30	10
29164	T20	100	4.0	212	30	10
29165	T25	100	4.5	212	30	10
29166	T27	115	5.5	235	36	10
29167	T30	115	6.0	235	36	10
29168	T40	130	7.0	257	41	5

## For hex nuts.



### 5525 MicroFinish hex nut driver. Round blade.

Blade: Chrome-vanadium steel, through hardened, chrome-plated.  
Deep drawn socket.  
Handle: Non-slip Wiha MicroFinish handle with roll-off protection.  
Standards: DIN 3125.  
Application: Best suited for turning screws in wet and oily applications.

Order-No.	⊙	↔	↔	+	↔	↔
29170	5.5	125	237	30	7.9	10
29171	6	125	237	30	8.9	10
29172	7	125	245	36	10.9	10
29173	8	125	245	36	11.9	10
29174	10	125	245	36	14.4	10



### 5528 MicroFinish hex nut driver. Flexible shaft for hard to reach areas.

Handle: Non-slip Wiha MicroFinish handle with roll-off protection.  
Application: E.g. for tightening and loosening adjustable hose clamps.

Order-No.	⊙	↔	↔	+	↔	↔
29175	6	150	262	30	9	10
29176	7	150	270	36	11	10
29177	8	150	270	36	12	10

## TORX® set.



### 5527 K6 MicroFinish TORX® screwdriver set, 6 pcs. Round blades.

Blade: High quality chrome-vanadium-molybdenum steel, through hardened, chrome-plated.  
Wiha ChromTop® finish on tip for a perfect fit every time.  
Handle: Non-slip Wiha MicroFinish handle with roll-off protection.  
Application: Best suited for turning screws in wet and oily applications.

Order-No.	Series	↔
29169	5527 K6	1
⊕	5527	T10x80 T15x80 T20x100 T25x100 T30x115 T40x130

## Sets with round blades.



**5520 HK6** MicroFinish slotted/ Phillips screwdriver set, 6 pcs.  
Round blades.

Blade: High quality chrome-vanadium-molybdenum steel, through hardened, chrome-plated.

Wiha ChromTop® finish on tip for a perfect fit every time.

Handle: Non-slip Wiha MicroFinish handle with roll-off protection.

Application: Best suited for turning screws in wet and oily applications.

Order-No.	Series					
29124	5520 HK6					1
⓪	5520	3.5x100	4.0x100	5.5x125	6.5x150	
⊕	5521	PH1x80	PH2x100			

## Sets with steel caps.



**5533 HK5** MicroFinish slotted/ Phillips screwdriver set, 5 pcs.  
Hex blades with hex bolster, solid steel cap.

Blade: High quality chrome-vanadium-molybdenum steel, through hardened, chrome-plated.

Wiha ChromTop® finish on tip for a perfect fit every time.

Handle: Non-slip Wiha MicroFinish handle with roll-off protection.

Application: Best suited for turning screws in wet and oily applications.

Order-No.	Series				
29138	5533 HK5				1
⓪	5533	5.5x100	6.5x125	8.0x150	
⊕	5534	PH1x80	PH2x100		



**5520 ZK6** MicroFinish slotted/ Pozidriv screwdriver set, 6 pcs.  
Round blades.

Blade: High quality chrome-vanadium-molybdenum steel, through hardened, chrome-plated.

Wiha ChromTop® finish on tip for a perfect fit every time.

Handle: Non-slip Wiha MicroFinish handle with roll-off protection.

Application: Best suited for turning screws in wet and oily applications.

Order-No.	Series					
29125	5520 ZK6					1
⓪	5520	3.5x100	4.0x100	5.5x125	6.5x150	
⊕	5522	PZ1x80	PZ2x100			



**5533 ZK5** MicroFinish slotted/ Pozidriv screwdriver set, 5 pcs.  
Hex blades with hex bolster, solid steel cap.

Blade: High quality chrome-vanadium-molybdenum steel, through hardened, chrome-plated.

Wiha ChromTop® finish on tip for a perfect fit every time.

Handle: Non-slip Wiha MicroFinish handle with roll-off protection.

Application: Best suited for turning screws in wet and oily applications.

Order-No.	Series				
29139	5533 ZK5				1
⓪	5533	5.5x100	6.5x125	8.0x150	
⊕	5535	PZ1x80	PZ2x100		



# Wiha Classic.

The classic for a range of uses.



*The Wiha Classic, resistant to chemicals and oils, impact resistant and cadmium-free – and also copes with a few hammer blows.*

The Classic screwdriver from Wiha proves its reliability on a daily basis in a wide variety of applications. Its robust handle of high quality plastic is impact resistant, shatter-proof and recyclable.

Users appreciate its versatility and high quality, which is also conveyed by the hardened chrome-vanadiummolybdenum steel blade.



*Wiha Classic – the robust and diverse square handle.*



*The slender Classic even fits into the narrow pockets of work trousers.*



## Wiha Classic.

- Universal use, and successful for many years
- Robust, large-surface handle made of impact-resistant plastic material, chemical and oil-resistant
- Smooth handle surface allows easy cleaning
- Wiha ChromTop®-finish on tip for a perfect fit every time



**For slotted screws.**



**186 Classic slotted screwdriver. Round blade.**

Blade: Chrome-vanadium steel, through hardened, nickel-plated. Tip and blade width identical up to size 6.0.  
 Handle: Impact resistant Wiha Classic handle, resistant to chemicals and oils.  
 Application: For universal use in trade and industry.  
 Extra: Series includes extra long dimensions for screws that are difficult to access.

Order-No.	⌀	↔	⊖	●	↔	↔	↔
00201	2.0	40	0.4	2.0	100	14	10
00202	2.0	60	0.4	2.0	120	14	10
00203	2.5	50	0.4	2.5	110	14	10
00204	2.5	75	0.4	2.5	150	19	10
00206	3.0	75	0.5	3.0	150	19	10
00207	3.0	100	0.5	3.0	175	19	10
00208	3.0	150	0.5	3.0	225	19	10
00209	3.0	200	0.5	3.0	285	22	10
00210	3.0	300	0.5	3.0	385	22	5
00211	3.5	100	0.6	3.5	175	19	10
00212	4.0	100	0.8	4.0	185	22	10
00213	4.0	150	0.8	4.0	235	22	10
00214	4.0	200	0.8	4.0	285	22	10
00215	4.0	300	0.8	4.0	385	22	5
00218	5.0	100	0.9	5.0	195	24	10
00219	5.0	150	0.9	5.0	245	24	10
00220	5.0	200	0.9	5.0	295	24	10
00221	5.0	300	0.9	5.0	395	24	5
00222	5.5	100	1.0	5.5	195	24	10
00223	5.5	150	1.0	5.5	245	24	10
00226	6.0	100	1.1	6.0	205	28	10
00227	6.0	150	1.1	6.0	255	28	10
00229	6.0	300	1.1	6.0	405	28	5
00230	7.0	150	1.2	6.0	255	28	10
00231	8.0	150	1.2	7.0	265	32	10
00234	8.0	300	1.2	7.0	415	32	5
00235	10.0	200	1.6	8.0	315	32	5
00236	10.0	300	1.6	8.0	415	32	5
00237	10.0	500	1.6	8.0	615	32	5



**148 Classic slotted screwdriver. Round blade.**

Blade: Chrome-vanadium steel, through hardened, nickel-plated. Anti-Cam-Out ribs on tips from size 5.5.  
 Handle: Impact resistant Wiha Classic handle, resistant to chemicals and oils.  
 Application: For universal use in trade and industry.

Order-No.	⌀	↔	⊖	●	↔	↔	↔
00097	2.5	75	0.4	3.5	150	19	10
00098	3.5	90	0.5	4.0	175	22	10
00099	4.5	100	0.7	5.0	195	24	10
00100	5.5	120	0.95	6.0	225	28	10
00101	7.0	140	1.05	7.0	225	32	10
00102	9.0	160	1.2	8.0	275	32	10
00103	10.0	180	1.4	8.0	305	36	10

**For Phillips, Pozidriv and TORX® screws.**



**153 Classic Phillips screwdriver. Round blade.**

Blade: Chrome-vanadium steel, through hardened, nickel-plated.  
 Handle: Impact resistant Wiha Classic handle, resistant to chemicals and oils.  
 Standards: ISO 8764.  
 Application: For universal use in trade and industry.

Order-No.	⊕	↔	●	↔	↔	↔
00109	PH0	60	3.0	135	19	10
00111	PH1	80	4.5	175	24	10
00112	PH1•	200	4.5	295	24	10
00115	PH2	100	6.0	205	28	10
00116	PH2•	250	6.0	355	28	10
00117	PH2•	350	6.0	455	28	5
00119	PH3	150	8.0	265	32	10
00120	PH3•	300	8.0	415	32	5

• Additional dimension. Non-DIN size.



**222 Classic Pozidriv screwdriver. Round blade.**

Blade: Chrome-vanadium steel, through hardened, chrome-plated.  
 Handle: Impact resistant Wiha Classic handle, resistant to chemicals and oils.  
 Standards: ISO 8764.  
 Application: For universal use in trade and industry.

Order-No.	⊕	↔	●	↔	↔	↔
00416	PZ0	60	3.0	135	19	10
00418	PZ1	80	4.5	175	24	10
00422	PZ1	100	6.0	205	28	10
00423	PZ2•	250	6.0	355	28	5
00426	PZ3	150	8.0	265	32	10

• Additional dimension. Non-DIN size.



**360 Classic TORX® screwdriver. Round blade.**

Blade: Chrome-vanadium steel, through hardened, black-finish.  
 Handle: Impact resistant Wiha Classic handle, resistant to chemicals and oils.  
 Application: For universal use in trade and industry.

Order-No.	⊗	↔	●	↔	↔	↔
05280	T5	50	2.5	110	14	10
01264	T6	50	3.5	125	19	10
01266	T8	60	3.5	135	19	10
01267	T9	60	4.0	145	22	10
01268	T10	80	4.0	175	24	10
01269	T15	80	4.0	175	24	10
01270	T20	100	4.0	205	28	10
01271	T25	100	4.5	205	28	10

# Wiha Classic.

The classic for a range of uses.

## For hex nuts and hex socket screws.



### 353 Classic hex screwdriver. Hex blade.

Blade: Chrome-vanadium steel, through hardened, nickel-plated.  
Handle: Impact resistant Wiha Classic handle, resistant to chemicals and oils.  
Application: For universal use in trade and industry.

Order-No.	⊙	↔	↔	⊕	⊖
01224	1.5	60	120	14	10
01225	2	60	120	14	10
01226	2.5	75	150	19	10
01227	3	75	150	19	10
01228	4	75	160	22	10
01229	5	75	170	24	10



### 342 Classic hex nut driver. Round blade.

Blade: Chrome-vanadium steel, through hardened, nickel-plated.  
Deep drawn socket.  
Handle: Impact resistant Wiha Classic handle, resistant to chemicals and oils.  
Standards: DIN 3125.  
Application: For universal use in trade and industry.

Order-No.	⊙	↔	↔	⊕	⊖	⊖
01051	3	125	220	24	5.0	10
01053	3.5	125	220	24	6.4	10
01054	4	125	220	24	6.9	10
01055	4.5	125	220	24	6.9	10
01056	5	125	220	24	7.9	10
01057	5.5	125	220	24	7.9	10
01058	6	125	220	24	8.9	10
01059	7	125	230	28	10.9	10
01060	8	125	230	28	11.9	10
01061	9	125	230	28	12.9	10
01062	10	125	230	28	14.4	10
01063	11	125	240	32	15.9	10
01064	12	125	240	32	16.9	10
01065	13	125	240	32	18.4	10

## Slotted/ Phillips and slotted/ Pozidriv sets.



### 148 HK5 Classic slotted/ Phillips screwdriver set, 5-pcs. Round blades.

Blade: Chrome-vanadium steel, through hardened, nickel-plated.  
Anti-Cam-Out ribs on tip sizes 5.5 / 7.0.  
Handle: Impact resistant Wiha Classic handle, resistant to chemicals and oils.  
Application: For universal use in trade and industry.

Order-No.	Series				⊖
00105	148 HK5				1
⊕	148	4.5x100	5.5x120	7.0x140	
⊕	153	PH1x80	PH2x100		



### 148 ZK5 Classic slotted/ Pozidriv screwdriver set, 5-pcs. Round blades.

Blade: Chrome-vanadium steel, through hardened, nickel-plated.  
Anti-Cam-Out ribs on tip sizes 5.5 / 7.0.  
Handle: Impact resistant Wiha Classic handle, resistant to chemicals and oils.  
Application: For universal use in trade and industry.

Order-No.	Series				⊖
00108	148 ZK5				1
⊕	148	4.5x100	5.5x120	7.0x140	
⊕	222	PZ1x80	PZ2x100		

# Wiha special tools.

Scraper, clamp lifter, reamer, awl and small screwdriver.

## Special tools.



### K 430 20 Seal scraper.

Blade: Chrome-vanadium steel, through-hardened.  
Handle: Wiha Power handle, impact, oil and grease resistant.  
Application: For easy removing of sealing materials, e.g. in automotive applications.

Order-No.					
01532	25	150	260	36	10



### K 430 10 Trim pin remover.

Blade: Chrome-vanadium steel, through hardened, chrome-plated.  
Handle: Wiha Power handle, impact, oil and grease resistant.  
Application: For fast removal of trim pins, e.g. on internal car panels.

Order-No.					
01531	7.5	175	285	36	10



### 300-2 Reamer with square tip and plastic handle.

Blade: Chrome-vanadium steel, through hardened, nickel-plated.  
Handle: Made of cellulose acetate, transparent red.  
Application: For enlarging holes and drill holes.

Order-No.					
00679	6.0	100	185	34	10



### 301-2 Awl with round tip and plastic handle.

Blade: Chrome-vanadium steel, through hardened, nickel-plated.  
Handle: Made of cellulose acetate, transparent red.  
Application: For pre-punching holes and drill holes.

Order-No.					
00683	6.0	100	185	34	10

## Wiha pocket screwdrivers.



### 500 Slotted pocket screwdriver.

Blade: Chrome-vanadium steel, through hardened, nickel-plated.  
Handle: Wiha round handle, transparent red with pen clip.

Order-No.	⌀				
01537	3.0	40	3.0	100	11
01538	3.0	60	3.0	120	11
01539	3.0	80	3.0	140	11



### 509 Slotted pocket screwdriver.

Blade: Chrome-vanadium steel, through hardened, nickel-plated.  
Handle: Wiha round handle, transparent yellow.

Order-No.	⌀				
01548	2.0	40	2.0	85	8



### 198-1 Classic reversible slotted/ Phillips screwdriver.

Blade: Chrome-vanadium steel, through hardened, nickel-plated.  
Handle: Wiha round handle, oil and grease resistant.

Order-No.	⌀	⊕				
00328	6.0	PH2	6	160	90	22

## Wiha Info



Reamers and awls are also available with wood handles, see page 35.

# Wiha wooden handle.

The all-rounder for woodworking applications.



The Wiha wooden handle is made of untreated, sealed beechwood.

Its hex bolster and specially developed handle profile underlines its professional claim. This is expressed through the blade that extends to the end of the handle. This enables the user to loosen tightened screws with a hammer stroke, since the through blade conducts energy from the hammer stroke directly to the screw.

The handle end of the screwdriver is protected against damage by a high-quality, robust leather cap.



*Wiha wooden-handle screwdriver – the allrounder made of beech is particularly suitable for all woodworking applications.*



*The through-blade, hex bolster and leather cap are the professional features that are particularly prized by users.*

*With hex bolster for greater torque transfer.*



## Wiha wooden handle.

- Handle made of sealed beechwood
- High torque can be transmitted even on the tightest screw with the help of the hex bolster for wrenches
- Blade extending through handle transmits the energy of the hammer stroke directly to the tightened screw
- Handle end protected with high-quality leather cap
- Precision blade tip, blade material of chrome-vanadium steel



**For slotted, Phillips and Pozidriv screws.**



**162 Wooden slotted screwdriver.**

**Round blade with hex bolster.**

Blade: Chrome-vanadium steel, through hardened, nickel-plated.  
From size 5.5, blade extends through handle. Anti-cam-out ribs, hex bolster.

Handle: Wiha wooden handle made of sealed beech wood, handle end protected with high-quality leather cap.

Application: For all applications in woodworking and furniture industries.

Order-No.	⊖	↔	⊕	●	⊕	↔	↔	↔
00147	3.5	75	0.6	4.0	-	175	23	10
00151	4.5	90	0.8	5.0	-	190	23	10
00152	5.5	100	0.95	5.5	8	205	26	10
00153	7.0	125	0.95	6.0	10	230	26	10
00154	9.0	150	1.1	7.0	10	270	30	10
00156	10.0	175	1.2	8.0	13	295	30	10
00157	12.0	200	1.4	8.0	13	325	32	10
00158	14.0	250	1.75	10.0	16	380	34	5
00159	16.0	250	2.0	11.0	16	390	36	5



**129 Wooden Phillips screwdriver.**

**Round blade with hex bolster.**

Blade: Chrome-vanadium steel, through hardened, nickel-plated.

Handle: Wiha wooden handle made of sealed beech wood, handle end protected with high-quality leather cap.

Standards: DIN ISO 8764.

Application: For all applications in woodworking and furniture industries.

Order-No.	⊕	↔	●	⊕	↔	↔	↔
00057	PH1	80	4.5	8	180	23	10
00058	PH2	100	6.0	10	205	26	10
00059	PH3	150	8.0	13	270	30	10
00060	PH4	200	10.0	16	330	34	5



**221 Wooden Pozidriv screwdriver.**

**Round blade with hex bolster.**

Blade: Chrome-vanadium steel, through hardened, chrome-plated.

Handle: Wiha wooden handle made of sealed beech wood, handle end protected with high-quality leather cap.

Standards: DIN ISO 8764.

Application: For all applications in woodworking and furniture industries.

Order-No.	⊕	↔	●	⊕	↔	↔	↔
00412	PZ1	80	4.5	8	180	23	10
00413	PZ2	100	6.0	10	205	26	10
00414	PZ3	150	8.0	13	270	30	10

**Reamers, awls. Set combinations.**



**300-11 Reamer with square tip, wooden handle and striking plate.**

Blade: Chrome-vanadium steel, through hardened, nickel-plated.  
One-piece blade up to striking plate.

Handle: Made of beech, semi-gloss lacquered.

Application: For enlarging holes and drill holes in wood.

Order-No.	■	↔	↔	↔	↔
32179	6.0	100	190	36	10



**301-11 Awl with round tip, wooden handle and striking plate.**

Blade: Chrome-vanadium steel, through hardened, nickel-plated.  
One-piece blade up to striking plate.

Handle: Made of beech, semi-gloss lacquered.

Application: For pre-punching holes and drill holes in wood.

Order-No.	●	↔	↔	↔	↔
32180	6.0	100	190	36	10



**162 HK6 SO Wooden slotted/ Phillips screwdriver set, 6 pcs.**

**Round blade with hex bolster.**

Blade: Chrome-vanadium steel, through hardened, nickel-plated.  
From size 5.5, blade extends through handle. Anti-cam-out ribs, hex bolster.

Handle: Wiha wooden handle made of sealed beech wood, handle end protected with high-quality leather cap.

Order-No.	Series				
07149	162 HK6 SO	1			
⊖	162	3.5x75	4.5x90	5.5x100	7.0x125
⊕	129	PH1x80	PH2x100		

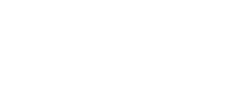

**162 ZK6 SO Wooden slotted/ Pozidriv screwdriver set, 6 pcs.**

**Round blade with hex bolster.**

Order-No.	Series				
07150	162 ZK6 SO	1			
⊖	162	3.5x75	4.5x90	5.5x100	7.0x125
⊕	221	PZ1x80	PZ2x100		



# Wiha PicoFinish.

The comfortable precision screwdriver.



Screw symbols printed in white on the rotating cap make it easier to identify each screwdriver.

The PicoFinish is distinguished by top-quality materials and an ergonomic handle design. The comfortable precision screwdriver with multi-component handle, rapid rotating zone and easy-movement rotating cap is a professional tool for all precision work for confined screw applications. To make things even easier for the user working with tiny screws, we've developed a second, smaller handle. The colour-coded marking of the drive symbol on the rotating cap is also new. This makes it easier to recognise the individual screwdrivers when several are being used at once.



precise ChromTop® tip ensures a secure hold in the screw head.



The smooth-running turn-cap protects the palm of your hand.

The blades are made of top-quality chrome-vanadium-molybdenum steel to ensure a particularly long tool life. They are subsequently through-hardened in a controlled process and chrome-plated. The



## Wiha PicoFinish.

- Ergonomic handle design with soft zone for comfortable work
- Easy-movement rotating cap for rapid hand action
- The white imprint of the screw symbol eases recognition
- Through-hardened, chrome-plated blade made of chrome-vanadium-molybdenum steel for a long tool life
- Wiha ChromTop® tip guarantees a secure hold in the screw head
- Ideal for all fine, filigree applications in electronics and precision-mechanics applications, as well as for DIY and model-building

**For slotted and Phillips screws.**



**260P PicoFinish slotted screwdriver.**  
Handle with rotating cap and rapid-turning zone.

Blade: High quality chrome-vanadium-molybdenum steel, through hardened, chrome-plated.

Wiha ChromTop® finish on tip for a perfect fit every time.

Handle: Wiha PicoFinish handle for sensitive and fast screw fixing.

Application: Ideal for fine and delicate fastening tasks for electronics, precision mechanics, model-making and hobby activities.

Order-No.	⌀	↔	⊖	●	↔	+	⊞
00475	0.8	40	0.16	2.0	134	9	10
00476	1.0	40	0.18	2.0	134	9	10
00477	1.2	40	0.2	2.0	134	9	10
00478	1.5	40	0.25	2.0	134	9	10
00479	1.5	60	0.25	2.0	154	9	10
00480	1.8	40	0.3	2.0	134	9	10
00481	1.8	60	0.3	2.0	154	9	10
00482	2.0	40	0.4	2.0	140	18	10
00484	2.0	60	0.4	2.0	160	18	10
00485	2.0	100	0.4	2.0	200	18	10
00486	2.5	50	0.4	2.5	150	18	10
00487	2.5	75	0.4	2.5	175	18	10
00488	2.5	100	0.4	2.5	200	18	10
00490	3.0	50	0.5	3.0	150	18	10
00492	3.0	100	0.5	3.0	200	18	10
00493	3.0	150	0.5	3.0	250	18	10
00495	3.5	60	0.6	3.5	160	18	10
00497	4.0	60	0.8	4.0	160	18	10
00498	4.0	100	0.8	4.0	200	18	10
00499	4.0	150	0.8	4.0	250	18	10



**261P PicoFinish Phillips screwdriver.**  
Handle with rotating cap and rapid-turning zone.

Blade: High quality chrome-vanadium-molybdenum steel, through hardened, chrome-plated.

Wiha ChromTop® finish on tip for a perfect fit every time.

Handle: Wiha PicoFinish handle for sensitive and fast screw fixing.

Application: Ideal for fine and delicate fastening tasks for electronics, precision mechanics, model-making and hobby activities.

Order-No.	⊕	↔	●	↔	+	⊞
00513	PH000	40	2.0	134	9	10
00512	PH00	40	2.0	134	9	10
00514	PH00	60	2.0	154	9	10
00511	PH0	50	3.0	150	18	10
00515	PH0	75	3.0	175	18	10
00516	PH1	60	4.0	160	18	10
00517	PH1	80	4.0	180	18	10
00518	PH1	150	4.0	250	18	10

**For Pozidriv and TORX® screws.**



**262P PicoFinish Pozidriv screwdriver.**  
Handle with rotating cap and rapid-turning zone.

Order-No.	⊕	↔	●	↔	+	⊞
04461	PZ0	50	3.0	150	18	10
04462	PZ1	60	4.0	160	18	10



**267P PicoFinish TORX® screwdriver.**  
Handle with rotating cap and rapid-turning zone.

Order-No.	⊕	↔	●	↔	+	⊞
25673	T1	40	2.5	134	9	10
25674	T2	40	2.5	134	9	10
20122	T3	40	2.5	134	9	10
20123	T4	40	2.5	134	9	10
00566	T5	40	2.5	134	9	10
00567	T6	40	2.5	140	18	10
00568	T7	40	2.5	140	18	10
00569	T8	40	2.5	140	18	10
00570	T9	50	3.0	150	18	10
00571	T10	50	3.0	150	18	10
00572	T15	60	3.5	160	18	10
00573	T20	60	4.0	160	18	10



**267PR PicoFinish TORX® MagicSpring® screwdriver.**  
Handle with rotating cap and rapid-turning zone.  
Retaining spring holds TORX® screws in place.

Blade: High quality chrome-vanadium-molybdenum steel, through hardened, chrome-plated.

Wiha ChromTop® finish on tip for a perfect fit every time.

Handle: Wiha PicoFinish handle for sensitive and fast screw fixing.

Application: Ideal for fine and delicate fastening tasks for electronics, precision mechanics, model-making and hobby activities.

Order-No.	⊕	↔	●	↔	+	⊞
27729	T6	40	2.5	140	18	10
27730	T7	40	2.5	140	18	10
27731	T8	40	2.5	140	18	10
27732	T9	50	3.0	150	18	10
27733	T10	50	3.0	150	18	10
27734	T15	60	3.5	160	18	10

# Wiha PicoFinish.

The comfortable precision screwdriver.

## For TORX PLUS® screws.



### 267PIP PicoFinish TORX PLUS® screwdriver.

**Handle with rotating cap and rapid-turning zone.**

Blade: High quality chrome-vanadium-molybdenum steel, through hardened, chrome-plated.

Wiha ChromTop® finish on tip for a perfect fit every time.

Handle: Wiha PicoFinish handle for sensitive and fast screw fixing.

Application: Ideal for fine and delicate fastening tasks for electronics, precision mechanics, model-making and hobby activities.

Extra: The stronger profile of the TORX PLUS® tip allows up to 25% extra torque than the TORX® profile.

Order-No.	Tip	Length	Tip Length	Tip Width	Tip Height	Tip Thickness
29100	4IP	40	2.5	134	9	10
29101	5IP	40	2.5	134	9	10
29102	6IP	40	2.5	140	18	10
29103	7IP	40	2.5	140	18	10
29104	8IP	40	2.5	140	18	10
29105	9IP	50	3.0	150	18	10
29106	10IP	50	3.0	150	18	10
29107	15IP	60	3.5	160	18	10
29108	20IP	60	4.0	160	18	10



### NEW

### 267PIPR PicoFinish TORX PLUS® security screwdriver (tamper-resistant).

**Handle with rotating cap and rapid-turning zone.**

Blade: High quality chrome-vanadium-molybdenum steel, through hardened, chrome-plated.

Wiha ChromTop® finish on tip for a perfect fit every time.

Handle: Wiha PicoFinish handle for sensitive and fast screw fixing.

Application: Ideal for repairing smartphones, tablets, notebooks, etc.

Attention: The guarantee and warranty conditions of the device manufacturer must be observed!

Security profile - sold only to authorised customers. Written proof of authorisation must be received.

Order-No.	Tip	Length	Tip Length	Tip Width	Tip Height	Tip Thickness
38837	1IPR	40	2.5	134	9	10
38838	2IPR	40	2.5	134	9	10
38839	3IPR	40	2.5	134	9	10
38840	4IPR	40	2.5	134	9	10
38842	5IPR	40	2.5	134	9	10
38843	6IPR	40	2.5	140	18	10

## For hex socket screws.



### 263P PicoFinish hex screwdriver.

**Handle with rotating cap and rapid-turning zone.**

Blade: High quality chrome-vanadium-molybdenum steel, through hardened, chrome-plated.

Wiha ChromTop® finish on tip for a perfect fit every time.

Handle: Wiha PicoFinish handle for sensitive and fast screw fixing.

Application: Ideal for fine and delicate fastening tasks for electronics, precision mechanics, model-making and hobby activities.

Order-No.	Tip	Length	Tip Length	Tip Width	Tip Height	Tip Thickness
00519	0.7	40	0.028	134	9	10
00520	0.9	40	0.035	134	9	10
00521	1.3	40	0.05	134	9	10
00522	1.5	50	-	144	9	10
00523	2.0	50	5/64	150	18	10
00524	2.5	60	-	160	18	10
00525	3.0	60	-	160	18	10

### 263P Zoll PicoFinish hex screwdriver. Inch sizes.

**Handle with rotating cap and rapid-turning zone.**

Order-No.	Tip	Length	Tip Length	Tip Width	Tip Height	Tip Thickness
00526	1/16	50	144	9	10	10
00528	3/32	60	160	18	10	10
00530	7/64	60	160	18	10	10
00527	1/8	60	160	18	10	10



### 264P PicoFinish ball end hex screwdriver.

**Handle with rotating cap and rapid-turning zone.**

Blade: High quality chrome-vanadium-molybdenum steel, through hardened, chrome-plated.

Wiha ChromTop® finish on tip for a perfect fit every time.

Handle: Wiha PicoFinish handle for sensitive and fast screw fixing.

Application: Ideal for fine and delicate fastening tasks for electronics, precision mechanics, model-making and hobby activities.

Extra: The ball end enables the user to work at angles up to 25°.

Order-No.	Tip	Length	Tip Length	Tip Width	Tip Height	Tip Thickness
00531	1.3	40	0.05	134	9	10
00532	1.5	50	-	150	18	10
00533	2.0	50	-	150	18	10
00534	2.5	60	-	160	18	10
00535	3.0	60	-	160	18	10

### 264P Zoll PicoFinish ball end hex screwdriver. Inch sizes.

**Handle with rotating cap and rapid-turning zone.**

Order-No.	Tip	Length	Tip Length	Tip Width	Tip Height	Tip Thickness
00537	1/16	50	150	18	10	10
00541	5/64	50	150	18	10	10
00539	3/32	50	150	18	10	10
00542	7/64	60	160	18	10	10
00538	1/8	60	160	18	10	10
00543	9/64	60	160	18	10	10
00540	5/32	60	160	18	10	10

## For hex nuts. Chip lifter.

**265P** PicoFinish hex nut driver.**Handle with rotating cap and rapid-turning zone.**

Blade: Chrome-vanadium steel, through hardened, chrome-plated.

Handle: Wiha PicoFinish handle for sensitive and fast screw fixing.

Application: Ideal for fine and delicate fastening tasks for electronics, precision mechanics, model-making and hobby activities.

Order-No.	Ø	↔	↔	↔	↔	↔	↔
00544	1.5	60	2.5	3.0	160	18	10
00545	1.8	60	2.9	3.5	160	18	10
00546	2	60	3.2	4.0	160	18	10
00547	2.5	60	4.0	4.0	160	18	10
00548	3	60	5.0	5.0	160	18	10
00549	3.2	60	5.0	5.0	160	18	10
00550	3.5	60	5.3	6.0	160	18	10
00551	4	60	5.5	6.0	160	18	10
00552	4.5	60	6.2	7.0	160	18	10
00553	5	60	6.8	7.0	160	18	10
00554	5.5	60	7.6	8.0	160	18	10
00555	6	60	8.2	9.0	160	18	10
00556	7	60	9.6	10.0	160	18	10

**265P Zoll** PicoFinish hex nut driver. Inch sizes.**Handle with rotating cap and rapid-turning zone.**

Order-No.	Ø	↔	↔	↔	mm	↔
00561	3/32	60	160	18	2.38	10
00564	7/64	60	160	18	2.78	10
00559	1/8	60	160	18	3.18	10
00565	9/64	60	160	18	3.57	10
00562	5/32	60	160	18	3.97	10
00560	3/16	60	160	18	4.76	10
00563	7/32	60	160	18	5.56	10
00558	1/4	60	160	18	6.35	10

**268P** PicoFinish chip lifter.

Blade: High quality chrome-vanadium-molybdenum steel, through hardened, chrome-plated.

Handle: Wiha PicoFinish handle.

Application: For lifting tight parts on circuit boards.

Order-No.	↔	↔	↔	↔	↔	↔
00574	1	3.5	50	150	18	5

## Hex sets.

**263P K6** PicoFinish hex screwdriver set, 6 pcs.**Handle with rotating cap and rapid-turning zone.**

Blade: High quality chrome-vanadium-molybdenum steel, through hardened, chrome-plated.

Wiha ChromTop® finish on tip for a perfect fit every time.

Handle: Wiha PicoFinish handle for sensitive and fast screw fixing.

Application: Ideal for fine and delicate fastening tasks for electronics, precision mechanics, model-making and hobby activities.

Extra: Practical plastic rack with hanging holes.

Order-No.	Series	↔
38162	263P K6	1
●	263P	0.9x40 1.3x40 1.5x50 2.0x50
		2.5x60 3.0x60

**264P K6** PicoFinish ball end hex screwdriver set, 6 pcs.**Handle with rotating cap and rapid-turning zone.**

Blade: High quality chrome-vanadium-molybdenum steel, through hardened, chrome-plated.

Wiha ChromTop® finish on tip for a perfect fit every time.

Handle: Wiha PicoFinish handle for sensitive and fast screw fixing.

Application: Ideal for fine and delicate fastening tasks for electronics, precision mechanics, model-making and hobby activities.

Extra: Practical plastic rack with hanging holes.

The ball end enables the user to work at angles up to 25°.

Order-No.	Series	↔
00536	264P K6	1
●	263P	0.9x40
●	264P	1.3x40 1.5x50 2.0x50 2.5x60
		3.0x60



# Wiha PicoFinish.

The comfortable precision screwdriver.

## Slotted/ Phillips sets.



**260P K6** PicoFinish slotted/ Phillips screwdriver set, 6 pcs.  
Handle with rotating cap and rapid-turning zone.

Blade: High quality chrome-vanadium-molybdenum steel, through hardened, chrome-plated.

Wiha ChromTop® finish on tip for a perfect fit every time.

Handle: Wiha PicoFinish handle for sensitive and fast screw fixing.

Application: Ideal for fine and delicate fastening tasks for electronics, precision mechanics, model-making and hobby activities.

Extra: Practical plastic rack with hanging holes.

Order-No.	Series				
00503	260P K6				1
⓪	260P	1.5x40	2.0x40	2.5x50	3.0x50
⊕	261P	PH00x40	PH0x50		

## Display.



**260 VB1** PicoFinish display.  
Acryl glass display with 70 pieces.

Size: 22 x 19 x 35 cm (WxDxH).

Order-No.	Series				
36151	260 VB1				1
⓪	260P	7x1.5	7x1.8	7x2.0	7x2.5
		7x3.0	7x3.5		
⊕	261P	7xPH000	7xPH00	7xPH0	7xPH1



**260P K7** PicoFinish slotted/ Phillips screwdriver set, 7 pcs.  
Handle with rotating cap and rapid-turning zone.

Order-No.	Series				
00504	260P K7				1
⓪	260P	1.5x40	2.0x40	2.5x50	3.0x50
⊕	261P	PH00x40	PH0x50	PH1x60	

## TORX® sets.

**267P K6M** PicoFinish TORX® screwdriver set, 6 pcs.**Handle with rotating cap and rapid-turning zone.**

Blade: High quality chrome-vanadium-molybdenum steel, through hardened, chrome-plated.

Wiha ChromTop® finish on tip for a perfect fit every time.

Handle: Wiha PicoFinish handle for sensitive and fast screw fixing.

Application: Profi set for mobile phones and electrical devices.

Extra: Practical plastic rack with hanging holes.

Order-No.	Series				
24002	267P K6M				1
	267P	T4x40	T5x40	T6x40	T7x40
		T8x40	T9x50		

## TORX® MagicSpring® set. Nut driver set.

**267PR K6** PicoFinish TORX® MagicSpring® screwdriver set, 6 pcs.**Handle with rotating cap and rapid-turning zone.****Retaining spring holds TORX® screws in place.**

Blade: High quality chrome-vanadium-molybdenum steel, through hardened, chrome-plated.

Wiha ChromTop® finish on tip for a perfect fit every time.

Handle: Wiha PicoFinish handle for sensitive and fast screw fixing.

Application: For setting and tightening TORX® screws in difficult to access areas.

Extra: Practical plastic rack with hanging holes.

Order-No.	Series				
27747	267PR K6				1
	267PR	T6x40	T7x40	T8x40	T9x50
		T10x50	T15x60		

**267P K6** PicoFinish TORX® screwdriver set, 6 pcs.**Handle with rotating cap and rapid-turning zone.**

Blade: High quality chrome-vanadium-molybdenum steel, through hardened, chrome-plated.

Wiha ChromTop® finish on tip for a perfect fit every time.

Handle: Wiha PicoFinish handle for sensitive and fast screw fixing.

Application: Ideal for fine and delicate fastening tasks for electronics, precision mechanics, model-making and hobby activities.

Extra: Practical plastic rack with hanging holes.

Order-No.	Series				
03765	267P K6				1
	267P	T7x40	T8x40	T9x50	T10x50
		T15x60	T20x60		

**265P K6** PicoFinish hex nut driver set, 6 pcs.**Handle with rotating cap and rapid-turning zone.**

Blade: Chrome-vanadium steel, through hardened, chrome-plated.

Handle: Wiha PicoFinish handle for sensitive and fast screw fixing.

Application: Ideal for fine and delicate fastening tasks for electronics, precision mechanics, model-making and hobby activities.

Extra: Practical plastic rack with hanging holes.

Order-No.	Series				
00557	265P K6				1
	265P	2.5x60	3x60	3.5x60	4x60
		5x60	5.5x60		

# Wiha universal scraper.

Easily removes sealing, paint and glue.



*The razor sharp blade quickly removes sealing, paint and glue.*

The Wiha universal scraper is the optimal tool to quickly and easily remove seals, paint, glue and labels from glass and metallic surfaces.

The universal scraper is a robust tool with an ergonomic SoftFinish® multi-component handle. Due to the special handle shape ultimate user comfort is provided. The high quality blades have a very long life. If a blade change is necessary, it can be done quickly and easily using the unique blade changing device.

The Wiha universal scraper is a tool which should be present in every professional toolbox. It also makes life easier for every home worker.



*The Wiha universal scraper can be used for the easy removal of gasket remains.*



## Wiha universal scraper.

- Removes quickly seals, paint, glue and labels
- High-quality blades have a very long life
- Square blade geometry, ideal for corners and edges
- Unique blade changing device ensures easy blade change
- Ergonomically shaped SoftFinish® multi-component handle for maximum user comfort

## Universal scraper.



### 430 40 Universal scraper starter set.

With 1 razor-edged blade, 13 mm wide.

Handle: Ergonomic Wiha SoftFinish® multi-component handle with roll-off protection.

Application: Removes sealing materials, glue residue, tape, labels.

Order-No.		
23159	Universal scraper with 1 blade	5



### SB 430 4010 Universal scraper set.

With 10 razor-edged replacement blades, 13 mm wide.

Blister packed.

Handle: Ergonomic Wiha SoftFinish® multi-component handle with roll-off protection.

Application: Removes sealing materials, glue residue, tape, labels.

Order-No.		
26920	Universal scraper with 1 blade and 10 replacement blades	5

## Replacement blades.



**SB 430 40 K10** Replacement blades for universal scraper.  
13 mm wide.  
Blister packed, 10 pcs.

Order-No.		
27606		1



**SB 430 40 K1020** Replacement blades for universal scraper.  
20 mm wide.  
Blister packed, 10 pcs.

Order-No.		
27902		1

# Wiha special tools

## Magnetisers/demagnetisers.



### 400 10 Magnetisers/demagnetisers.

Size: 52 x 50 x 29 mm (b x h x d)

Application: For magnetising and demagnetising of blades and blade-similar tools of steel.

Order-No.	
01508	5

### SB 400 10 Magnetisers/demagnetisers. Blister packed.

Size: 52 x 50 x 29 mm (b x h x d)

Application: For magnetising and demagnetising of blades and blade-similar tools of steel.

Order-No.	
02568	5



### 400 12 Magnetiser display.

Card display with 12 pieces.

Order-No.	Content	
24492	12 x 400 10	1

## Switch cabinet key.



NEW

### SB 246 81 Electrical universal switch cabinet key in pen form. Square, triangular drive, two-way key, 1/4" double bit. 145 mm long.

Material: The housing is made of high-tensile glass-fibre reinforced plastic includes 4 metal keys.

Dual swivel lock to use all the keys in the ideal position.

Application: Opening of switch cabinet locking systems in the fields of electrical engineering, gas and water supply, air conditioning and ventilation technology, as well as industrial applications.

Extra: Clip with key for radiator bleeder valves. 2 mounts for 1/4" double bits.

Order-No.							
39076	5 / 6 / 7-8	9	3-5	7.0	PH2	T20 / T25	5



### 246 67 Electrical universal switch cabinet key as a cross. Square, triangular drive, two-way key, 1/4" double bit. 76 mm long.

Material: Diecast zinc.

Application: Opening of switch cabinet locking systems in the fields of electrical engineering, gas and water supply, air conditioning and ventilation technology, as well as industrial applications.

Extra: Adapter for 1/4" double bit on fastening chain. With a radiator bleeder closure in the centre hub.

Order-No.						
36114	5 / 6 / 7-8	9	3-5	7.0	PH2	5



# Wiha screw extractor.

## Screw extractor



### 405 11 Screw extractor set with spiral drill bit, 16 pcs.

Material: Screw extractor of tough-yet-flexible chrome-vanadium-molybdenum steel, through-hardened, bronzed.

HSS spiral drill bit, blank.

Application: For thread-conserving removal of damaged or broken-off screws with left-hand or right-hand thread, particularly stripped hex screws. Simply hammer in the extractor, position the ring spanner to the bottom and screw out without tilting.

Order-No.	Series				
03988	405 11				1
●	405	2.0x85	2.5x85	3.0x85	4x85
		5x85	6x95	8x95	10x110
⊗		2.3x53	2.8x51	3.4x70	4.5x80
		5.7x93	6.8x109	9.0x117	11.0x142



### NEW

### 405 Screw extractor

Material: Tough-yet-flexible chrome-vanadium molybdenum steel, through-hardened, bronzed.

Application: For thread-conserving removal of damaged or broken-off screws with left-hand or right-hand thread, particularly a stripped hex screw. Simply hammer in the extractor, position the ring spanner to the bottom and screw out without tilting.

Order-No.	●	↔	⊗	
03847	2.0	85	6.0	1
03848	2.5	85	6.0	1
03849	3.0	85	7.0	1
03850	4	85	8.0	1
03851	5	85	8.0	1
03852	6	95	8.0	1
03853	8	95	10.0	1
03854	10	110	12.0	1

## Wiha Info

### Screw extractor

1 a



Damaged or rounded hex screw caps or...

2 a

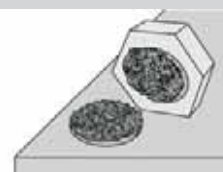

...broken-off screw head

2 b



Pre-drill with spiral drill bit

1 b

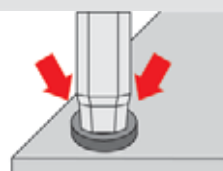

Firmly hammer in the screw extractor with a hammer

2 c

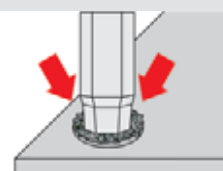

1 c

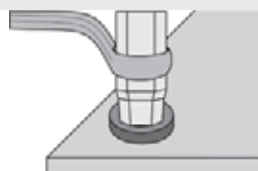

Slide in the ring spanner to the bottom and screw out without tilting

2 d

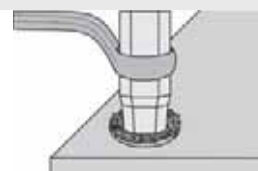

# Wiha slim family.

The innovation for VDE fastening tools.



## SoftFinish® electric



## slimFix

See page 50 – 53

- Actuating tool for spring clips (wedge-profiled output geometry)
- Effortless access to low-lying fastening and spring elements



## VDE exchange bit system



## slimVario

See page 56 – 59



See page 54 – 55

Compact VDE bit sets:  
holder + slimBit (length 75 mm)

- 35% lighter than comparable sets
- Maximum service life: metal locking mechanism
- Precise work – additional guidance with free-running sleeve

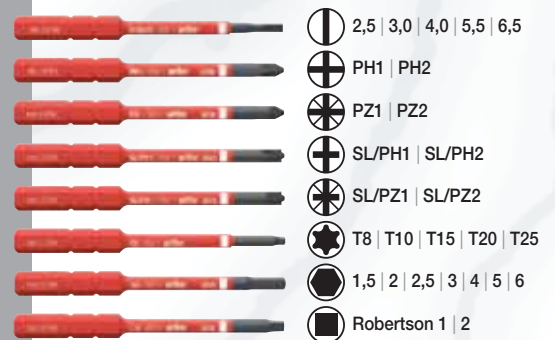

## VDE torque system



## slimTorque

See page 92 – 97

Controlled tightening of electrical screw connections with slimBits





- ⌀ 3,5 | 4,0 | 4,5 | 5,5 | 6,5
- ⊕ PH1 | PH2      ⊕ SL/PH1 | SL/PH2
- ⊗ PZ1 | PZ2      ◼ Robertson 1 | 2

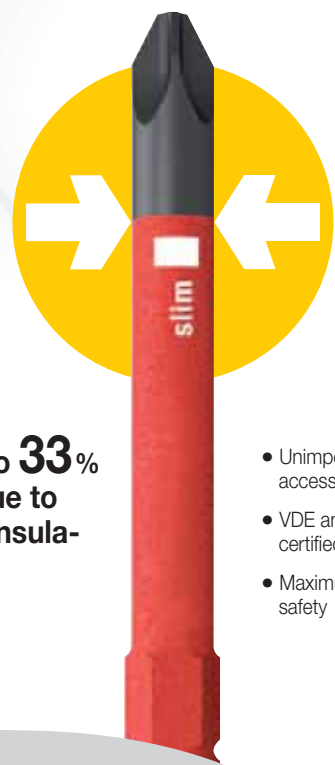

Blades up to **33%** narrower due to integrated insulation.

- Unimpeded accessibility
- VDE and GS certified
- Maximum safety

Plastic box



Bag



slim Selection Set



slimVario + slimTorque



# Wiha slim selection set.

All-in-one.



**slimVario**  
VDE exchange bit system



**slimTorque**  
VDE torque system



All  
in one –  
**slim Selection!**

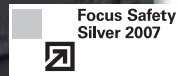

See page 60

## Wiha slimTECHNOLOGY :



### slimVario

Compact VDE bit sets:  
holder + slimBit (length 75 mm)

- 35% lighter than comparable sets
- Maximum service life: metal locking mechanism
- Precise work – additional guidance with free-running sleeve

### slimTorque

Controlled tightening of electrical screw connections with slimBits



# Wiha SoftFinish® electric slimFix.

The convenient slim solution for electrical applications.



product  
design  
award

2011



The right tool at a glance, thanks to the printed screw symbol on the handle end.

slimTECHNOLOGY



Applications on live equipment are subject to very special requirements. The focus is on absolute user safety and Wiha demonstrates this with a wealth of details.

The high quality blade insulation is moulded directly onto the blade and therefore guarantees safety when working on live equipment up to 1,500 V DC / 1,000 V AC. To maintain this safety, each screwdriver of the SoftFinish® electric series is individually tested in a water bath at 10,000 Volts according to IEC 60900:2012.

The roll-off protection and the special handle geometry offer optimum handling and electrical safety, even in critical applications.



**slimTECHNOLOGY:**  
Up to 33% reduction of the bit diameter in the critical working area allows effortless access to low-lying fastening/spring elements.



**Wiha SoftFinish® electric slimFix.**

- Unlimited access
- Blades up to 33% narrower due to integrated insulation
- Tool for spring clips (wedge-profiled output geometry)





**Safety Notice:**

When working with VDE tools, observe the national safety and accident prevention regulations!



**For slotted, Phillips and Pozidriv screws.**



**3201** SoftFinish® electric slimFix slotted screwdriver.  
Individually tested protective insulation 1,000 V AC, VDE and GS tested.

Blade: High quality chrome-vanadium-molybdenum steel, through hardened, black-finish. Protective insulation moulded directly onto the blade and completely integrated into the blade in the lower area.  
Handle: Ergonomic Wiha SoftFinish® multi-component handle with roll-off protection.  
Standards: DIN ISO 2380.  
Application: Manufactured acc. to IEC 60900:2012.  
Extra: For all work on or around electrical components up to 1,000 V AC. The integrated protective insulation enables low-lying fastening and spring elements to be reached and manipulated.

Order-No.	⊖	↔	⊕	↔	↔	↔
35446	3.5	100	0.6	204	23	10
35390	4.0	100	0.8	211	30	10
35501	4.5	125	1.0	236	30	10
35391	5.5	125	1.0	243	36	10
35392	6.5	150	1.2	268	36	10



**3211** SoftFinish® electric slimFix Phillips screwdriver.  
Individually tested protective insulation 1,000 V AC, VDE and GS tested.

Blade: DIN ISO 8764. Manufactured acc. to IEC 60900:2012.  
Application: The integrated protective insulation enables low-lying fastening elements to be reached and manipulated.

Order-No.	⊕	↔	↔	↔	↔
35393	PH1	80	191	30	10
35394	PH2	100	218	36	10



**3241** SoftFinish® electric slimFix Pozidriv screwdriver.  
Individually tested protective insulation 1,000 V AC, VDE and GS tested.

Blade: DIN ISO 8764. Manufactured acc. to IEC 60900:2012.  
Application: The integrated protective insulation enables low-lying fastening elements to be reached and manipulated.

Order-No.	⊕	↔	↔	↔	↔
35395	PZ1	80	191	30	10
35396	PZ2	100	218	36	10

**For TORX®, terminal- and square-drive screws.**



**3251** SoftFinish® electric slimFix TORX® screwdriver.  
Individually tested protective insulation 1,000 V AC, VDE and GS tested.

Blade: DIN ISO 8764. Manufactured acc. to IEC 60900:2012.  
Application: The integrated protective insulation enables low-lying fastening and spring elements to be reached and manipulated. Smaller sizes from T9 contained in the 325 series.

Order-No.	⊕	↔	↔	↔	↔
36536	T10	100	204	23	10
36537	T15	100	211	30	10
36538	T20	100	211	30	10
36539	T25	125	243	36	10
36540	T27	125	243	36	10
36541	T30	125	243	36	10
36542	T40	150	268	36	5



**3271** SoftFinish® electric slimFix Xeno screwdriver.  
For terminal screws (slotted/ Phillips).  
Individually tested protective insulation 1,000 V AC, VDE and GS tested.

Blade: Manufactured acc. to IEC 60900:2012.

Order-No.	⊕	↔	↔	↔	↔
35502	SL/PH1	80	191	30	10
35503	SL/PH2	100	218	36	10



**3281** SoftFinish® electric slimFix Xeno screwdriver.  
For terminal screws (slotted/ Pozidriv).  
Individually tested protective insulation 1,000 V AC, VDE and GS tested.

Blade: Manufactured acc. to IEC 60900:2012.

Order-No.	⊕	↔	↔	↔	↔
36329	SL/PZ1	80	191	30	10
36330	SL/PZ2	100	218	36	10



**3581** SoftFinish® electric slimFix square (Robertson) screwdrivers.  
Individually tested protective insulation 1,000 V AC, VDE and GS tested.

Blade: Manufactured acc. to IEC 60900:2012.

Order-No.	⊕	↔	↔	↔	↔	
35504	Robertson 1	2.3	100	211	30	10
35505	Robertson 2	2.8	125	243	36	10

# Wiha SoftFinish® electric slimFix.

The convenient slim solution for electrical applications.

## SoftFinish® electric slimFix sets.



**SB 3201 S201** SoftFinish® electric slimFix slotted/ Phillips screwdriver set, 2-pcs. Individually tested protective insulation 1,000 V AC, VDE and GS tested.

Blister packed.

Blade: High quality chrome-vanadium-molybdenum steel, through hardened, black-finish.

Protective insulation moulded directly onto the blade and completely integrated into the blade in the lower area.

Handle: Ergonomic Wiha SoftFinish® multi-component handle with roll-off protection.

Standards: Manufactured acc. to IEC 60900:2012.

Application: For all work on or around electrical components up to 1,000 V AC.

Extra: The integrated protective insulation enables low-lying fastening and spring elements to be reached and manipulated.



Order-No.	Series	
36331	SB 3201 S201	1
⓪	3201	3.5x100
⊕	3211	PH2x100



**SB 3201 S202** SoftFinish® electric slimFix slotted/ Pozidriv screwdriver set, 2-pcs. Individually tested protective insulation 1,000 V AC, VDE and GS tested.

Blister packed.

Order-No.	Series	
36332	SB 3201 S202	1
⓪	3201	3.5x100
⊕	3241	PZ2x100



**SB 3201 S204** SoftFinish® electric slimFix slotted/ Xeno screwdriver set, 2-pcs. For terminal screws (slotted/ Pozidriv).

Individually tested protective insulation 1,000 V AC, VDE and GS tested.

Blister packed.

Order-No.	Series	
36333	SB 3201 S204	1
⓪	3201	3.5x100
⊕	3281	SL/PZ2x100



## SoftFinish® electric slimFix sets.



**3201 K6** SoftFinish® electric slimFix slotted/ Phillips screwdriver set, 6 pcs. Individually tested protective insulation 1,000 V AC, VDE and GS tested.

Blade: High quality chrome-vanadium-molybdenum steel, through hardened, black-finish.

Protective insulation moulded directly onto the blade and completely integrated into the blade in the lower area.

Handle: Ergonomic Wiha SoftFinish® multi-component handle with roll-off protection.

Standards: Manufactured acc. to IEC 60900:2012.

Application: For all work on or around electrical components up to 1,000 V AC.

Extra: The integrated protective insulation enables low-lying fastening and spring elements to be reached and manipulated.



Order-No.	Series	
35389	3201 K6	1
⓪	3201	3.5x100 4.0x100 5.5x125 6.5x150
⊕	3211	PH1x80 PH2x100



**3201 ZK6** SoftFinish® electric slimFix slotted/ Pozidriv screwdriver set, 6-pcs. Individually tested protective insulation 1,000 V AC, VDE and GS tested.

Blade: Manufactured acc. to IEC 60900:2012.

Application: For all work on or around electrical components up to 1,000 V AC.

Extra: The integrated protective insulation enables low-lying fastening and spring elements to be reached and manipulated.



Order-No.	Series	
36455	3201 ZK6	1
⓪	3201	3.5x100 4.0x100 5.5x125 6.5x150
⊕	3241	PZ1x80 PZ2x100





**SoftFinish® electric slimFix sets.**



**NEW**  
**3201 K6 01**



**SoftFinish® electric slimFix slotted/Phillips/Pozidriv Xeno screwdriver set, 6-pcs.**  
Individually tested protective insulation 1,000 V AC, VDE and GS tested.

**Blade:** High quality chrome-vanadium-molybdenum steel, through hardened, black-finish.

Protective insulation moulded directly onto the blade and completely integrated into the blade in the lower area.

**Handle:** Ergonomic Wiha SoftFinish® multi-component handle with roll-off protection.

**Standards:** Manufactured acc. to IEC 60900:2012.

**Application:** For all work on or around electrical components up to 1,000 V AC.

**Extra:** The integrated protective insulation enables low-lying fastening and spring elements to be reached and manipulated.

Order-No.	Series					
<b>38362</b>	<b>3201 K6 01</b>					1
⓪	<b>3201</b>	3.5x100	4.0x100	5.5x125		
⊕	<b>3211</b>	PH1x80	PH2x100			
⊗	<b>3281</b>	SL/PZ2 x 100				



**3251 K6** **SoftFinish® electric slimFix TORX® screwdriver set, 6-pcs.**  
Individually tested protective insulation 1,000 V AC, VDE and GS tested.

**Blade:** Manufactured acc. to IEC 60900:2012.

**Application:** For all work on or around electrical components up to 1,000 V AC.

**Extra:** The integrated protective insulation enables low-lying fastening elements to be reached and manipulated.

Order-No.	Series					
<b>36558</b>	<b>3251 K6</b>					1
⊗	<b>325</b>	T8x60	T9x60			
⊗	<b>3251</b>	T10x100	T15x100	T20x100	T25x125	

**Displays.**



**3211 VB** **Display SoftFinish® electric slimFix.**  
**Card display with 18 pcs.**

**Size:** 28 x 13 x 36 cm (WxDxH).



**3241 VB** **Display SoftFinish® electric slimFix.**  
**Card display with 18 pcs.**

Order-No.	Series					
<b>35560</b>	<b>3241 VB</b>					1
⓪	<b>3201</b>	3x3.5	3x4.0	3x5.5	3x6.5	
⊕	<b>3241</b>	3xPZ1	3xPZ2			

# Wiha Magazine Bit Holder LiftUp electric.

With 6 slimBits.



A clever solution: 2 rockers pressed simultaneously unlock the bit depot



Turnable cap: Convenient way to add additional axial force



The magazine bit holder LiftUp electric is the latest development in the successful slimVario product line: a compact magazine bit holder which accommodates 6 common slimBits. This makes this tool the ideal companion for use on the move of any electrician.

Pressing both rockers extends the bit depot out of the magazine and provides all slimBits in a fanned-out presentation. Thus, removing and re-inserting individual slimBits is child's play. The proven ClicFix bit holder securely accommodates all the bits, locks them reliably and makes this tool a magazine which is suitable for universal use. The turnable cap is a further advantage. The required axial force can be built up by vigorously pressing the cap. The second hand is used to turn it along the longitudinal axis.

The magazine provides the maximum possible safety. In addition to the individually tested slimBits, the magazine is also completely VDE-GS certified. This means twice the safety for users.

In addition to their main application in the electrical field, these bits can also be used for mechanical fastening.



Each slimBit can be removed from the depot and re-inserted easily and conveniently



## Wiha Magazine Bit Holder LiftUp electric.

- **Light and universal**  
Ideal for use on the move
- **Does the job of 6 screwdrivers**  
All common drives are always to hand
- **Turnable cap**  
Convenient way to add additional axial force
- **Durable**  
Internal metal construction ensures bit holder doesn't wear
- **Maximum safety:**  
slimBit and magazine bit holder LiftUp electric are individually VDE-GS certified according to IEC 60900:2012

**Safety Notice:**  
For work in the area of live parts up to 1,000 V AC! 6 mm VDE exchange bits should be used only with the hand-held screwdriver supplied! When working with VDE tools, observe the national safety and accident prevention regulations!







**For slotted and Phillips screws.**



**NEW** 1000 V  
**2831 09 020** Magazine Bit Holder LiftUp electric with 6 slimBits.  
 Doubled safety: slimBits and magazine are individually VDE-GS tested.

Blade: Chrome-vanadium steel, through-hardened.  
 Insulation moulded directly onto blade.

Handle: Wiha SoftFinish® electric multi-component handle with roll-off protection.  
 Internal magazine accommodates 6 common slimBits.  
 Upon opening the magazine holder fans out enabling easy removal of slimBits.  
 Turnable cap for comfortable handling.

Bit holder: Insulated metal ClicFix bit holder locks all slimBits reliability.  
 Easily turnable guide sleeve provides support when fastening.  
 Suitable for 6 mm slimBits only.

Application: Compact magazine screwdriver for electrical applications, especially for mobile applications.

Attention: Not for use with bit styles C 6.3 and E 6.3.

Order-No.	Series				
<b>38610</b>	<b>2831 09 020</b>	5			
⓪	<b>2831-10</b>	1x2.5	1x3.0	1x4.0	1x5.5
⊕	<b>2831-11</b>	1xPH1	1xPH2		

**For slotted, Phillips and slotted/Pozidriv screws.**



**NEW** 1000 V  
**2831 09 021** Magazine Bit Holder LiftUp electric with 6 slimBits.  
 Doubled safety: slimBits and magazine are individually VDE-GS tested.

Blade: Chrome-vanadium steel, through-hardened.  
 Insulation moulded directly onto blade.

Handle: Wiha SoftFinish® electric multi-component handle with roll-off protection.  
 Internal magazine accommodates 6 common slimBits.  
 Upon opening the magazine holder fans out enabling easy removal of slimBits.  
 Turnable cap for comfortable handling.

Bit holder: Insulated metal ClicFix bit holder locks all slimBits reliability.  
 Easily turnable guide sleeve provides support when fastening.  
 Suitable for 6 mm slimBits only.

Application: Compact magazine screwdriver for electrical applications, especially for mobile applications.

Attention: Not for use with bit styles C 6.3 and E 6.3.

Order-No.	Series			
<b>38611</b>	<b>2831 09 021</b>	5		
⓪	<b>2831-10</b>	1x3.0	1x4.0	1x5.5
⊕	<b>2831-11</b>	1xPH1	1xPH2	
⊗	<b>2831-14</b>	1xSL/PZ2		



**NEW** 1000 V  
**SB 2831 09 020** Magazine Bit Holder LiftUp electric with 6 slimBits.  
 Doubled safety: slimBits and magazine are individually VDE-GS tested.  
 Blister packed.

Order-No.	Series				
<b>38612</b>	<b>SB 2831 09 020</b>	5			
⓪	<b>2831-10</b>	1x2.5	1x3.0	1x4.0	1x5.5
⊕	<b>2831-11</b>	1xPH1	1xPH2		



**NEW** 1000 V  
**SB 2831 09 021** Magazine Bit Holder LiftUp electric with 6 slimBits.  
 Doubled safety: slimBits and magazine are individually VDE-GS tested.  
 Blister packed.

Order-No.	Series			
<b>38613</b>	<b>SB 2831 09 021</b>	5		
⓪	<b>2831-10</b>	1x3.0	1x4.0	1x5.5
⊕	<b>2831-11</b>	1xPH1	1xPH2	
⊗	<b>2831-14</b>	1xSL/PZ2		

**Wiha Info**



**slimTECHNOLOGY:**

Up to 33% reduction of the blade diameter in the critical working area allows effortless access to low-lying fastening/ spring elements.



**NEW** 1000 V  
**2831 09** Magazine Bit Holder LiftUp electric, empty.  
 Can be filled with 6 slimBits.

Order-No.	Series	
<b>38361</b>		5

# Wiha SoftFinish® electric slimVario.

Maximum safety at minimum size.



product  
design  
award

2011



The perfect combination of functional bits, handy holders and maximum safety standards! The Wiha slimBits and SoftFinish® hand-held screwdriver were especially developed for mobile applications at various locations, e.g. building sites, solar systems or external switch cabinets. Perfect for the job with its light weight and compact geometry.



Its slim design and especially the protective insulation integrated into the bit means highly diverse applications. It can be used both as a mechanical and electrical fastening tool. The bit holder manufactured from metal parts gives the tool a long service life and an unusual level of ruggedness for everyday use. Added to that is an assortment of commonly used exchange bits and the pleasant SoftFinish® handle.

For all those unwilling to compromise in terms of safety and comfort.



**slimTECHNOLOGY:**  
Up to 33% reduction of the bit diameter in the critical working area allows effortless access to low-lying fastening/spring elements.

**Safety Notice:**

For work in the area of live parts up to 1,000 V AC! 6 mm VDE exchange bits should be used only with the hand-held screwdriver supplied! When working with VDE tools, observe the national safety and accident prevention regulations!



**Wiha SoftFinish® electric slimVario.**

- **Slim - light - mobile**  
Ideal for taking along
- **Durable**  
Internal metal construction ensures bit holder doesn't wear
- **Gets everywhere**  
Even in small apertures and low-lying fastening and spring elements
- **A firm hold**  
Optimal interplay of bit and holder
- **Certified quality**  
GS mark for inspected safety, one-off testing in a water bath at 10,000 V according to IEC 60900:2012



**Warning:**

6 mm slimBits only to be used in the slimVario bit holder and slimTorque VDE bit holder (VDE torque system).



**SoftFinish® electric slimVario. slimBits.**



1000 V IEC 60900:2012

**2831-00** SoftFinish® electric slimVario bit holder with handle and ClicFix, 6.0 mm.

Blade: Chrome-vanadium steel, through-hardened. Insulation moulded directly onto blade.  
 Handle: Wiha SoftFinish® electric multi-component handle with roll-off protection.  
 Bit holder: Insulated metal ClicFix bit holder locks all slimBits reliability. Only for 6 mm slimBits.  
 Application: Compact screwdriver together with slimBits.  
 Attention: Not for use with bit styles C 6.3 and E 6.3.

Order-No.	⊖	↔	⊕	⦿	max. Nm	⊞
34577	6	30	50	160	13	5



1000 V IEC 60900:2012

**2831-10** SoftFinish® electric slimBit, slotted. Individually tested protective insulation 1,000 V AC, VDE and GS tested.

Standards: Manufactured acc. to IEC 60900:2012.  
 Material: High-quality chrome vanadium steel, through-hardened, bronzed. Protective insulation moulded directly onto the bit and completely integrated into the blade in the lower area from size 4.0.  
 Application: For all work on or around electrical components up to 1,000 V AC.  
 Extra: The integrated protective insulation enables low-lying fastening and spring elements to be reached and manipulated. The slim form of the bit allows easy reaching of the screws below the finger and hand guards.  
 Attention: 6 mm slimBits only to be used in the slimVario bit holder and slimTorque VDE bit holder (VDE torque system).

Order-No.	⊖	↔	⊕	⦿	max. Nm	no slim version	⊞
34578	2.5	75	0.4	6.0	0.4	no slim version	1
34579	3.0	75	0.5	6.0	0.6	no slim version	1
34580	4.0	75	0.8	6.0	2.5		1
34581	5.5	75	1.0	6.0	5.5		1
34582	6.5	75	1.2	6.0	5.5		1



1000 V IEC 60900:2012

**2831-11** SoftFinish® electric slimBit, Phillips. Individually tested protective insulation 1,000 V AC, VDE and GS tested.

Order-No.	⊕	↔	⦿	max. Nm	⊞
34583	PH1	75	6.0	3.8	1
34584	PH2	75	6.0	5.5	1



1000 V IEC 60900:2012

**2831-12** SoftFinish® electric slimBit, Pozidriv. Individually tested protective insulation 1,000 V AC, VDE and GS tested.

Order-No.	⊕	↔	⦿	max. Nm	⊞
34585	PZ1	75	6.0	3.8	1
34586	PZ2	75	6.0	5.5	1

**slimBits.**



1000 V IEC 60900:2012

**2831-13** SoftFinish® electric slimBit, Xeno, for terminal screws (slotted/ Phillips). Individually tested protective insulation 1,000 V AC, VDE and GS tested.

Order-No.	⊕	↔	⦿	max. Nm	⊞
34587	SL/PH1	75	6.0	3.8	1
34588	SL/PH2	75	6.0	5.5	1



1000 V IEC 60900:2012

**2831-14** SoftFinish® electric slimBit, Xeno, for terminal screws (slotted/Pozidriv). Individually tested protective insulation 1,000 V AC, VDE and GS tested.

Order-No.	⊕	↔	⦿	max. Nm	⊞
34589	SL/PZ1	75	6.0	3.8	1
34590	SL/PZ2	75	6.0	5.5	1



1000 V IEC 60900:2012

**2831-15** SoftFinish® electric slimBit, TORX®. Individually tested protective insulation 1,000 V AC, VDE and GS tested.

Order-No.	⊕	↔	⦿	max. Nm	no slim version	⊞
35506	T8	75	6.0	1.3	no slim version	1
35507	T10	75	6.0	3.8	no slim version	1
35508	T15	75	6.0	5.0		1
35509	T20	75	6.0	5.5		1
36071	T25	75	6.0	5.5		1



1000 V IEC 60900:2012

**2831-18** SoftFinish® electric slimBit, hexagon. Individually tested protective insulation 1,000 V AC, VDE and GS tested.

Standards: High-quality chrome vanadium steel, through-hardened, bronzed. Protective insulation moulded directly onto the bit and completely integrated into the blade in the lower area from size 2.5.

Order-No.	⦿	↔	⦿	max. Nm	no slim version	⊞
37222	1.5	75	6.0	0.9	no slim version	1
37223	2	75	6.0	1.8	no slim version	1
37224	2.5	75	6.0	3.8		1
37147	3	75	6.0	5.5		1
37225	4	75	6.0	5.5		1
37226	5	75	6.0	5.5		1
37227	6	75	6.0	5.5		1



1000 V IEC 60900:2012

**2831-17** SoftFinish® electric slimBit, square (Robertson). Individually tested protective insulation 1,000 V AC, VDE and GS tested.

Order-No.	⦿	↔	⦿	max. Nm	⊞	
35510	Robertson 1	2.3	75	6.0	5.5	1
35511	Robertson 2	2.8	75	6.0	5.5	1

# Wiha SoftFinish® electric slimVario.

Maximum safety at minimum size.

## slimBit pack.



1000 V  
IEC 60900:2012

### 2831 B601 slimBit pack, slotted/ Phillips, 6-pcs.

Bits: High-quality chrome vanadium steel, through-hardened, bronzed. Protective insulation moulded directly onto the bit and completely integrated into the bit in the lower area.

Individually tested protective insulation 1,000 V AC, VDE and GS tested.

Application: For all work on or around electrical components up to 1,000 V AC.

Attention: 6 mm slimBits only to be used in the slimVario bit holder and slimTorque VDE bit holder (VDE torque system).

Order-No.	Series				
36088	2831 B601	1			
	⓪ 2831-10	1x2.5	1x3.0	1x4.0	1x5.5
	⊕ 2831-11	1xPH1	1xPH2		



1000 V  
IEC 60900:2012

### 2831 B602 slimBit pack, slotted/ Pozidriv, 6-pcs.

Order-No.	Series				
36089	2831 B602	1			
	⓪ 2831-10	1x2.5	1x3.0	1x4.0	1x5.5
	⊕ 2831-12	1xPZ1	1xPZ2		



1000 V  
IEC 60900:2012

### 2831 B603 slimBit pack, slotted/ Xeno (slotted/ Pozidriv), 6 pcs.

Order-No.	Series				
36090	2831 B603	1			
	⓪ 2831-10	1x2.5	1x3.0	1x4.0	1x5.5
	⊕ 2831-14	1xSL/PZ1	1xSL/PZ2		



### NEW 2831 B701 slimBit pack, hex, 7-pcs.

Order-No.	Series				
38997	2831 B701	1			
	⦿ 2831-18	1x1.5	1x2	1x2.5	1x3
		1x4	1x5	1x6	

## Sets.



1000 V  
IEC 60900:2012

### 2831 T701 SoftFinish® electric slimVario starter pack, slotted/ Phillips, 7 pcs.

Bit holder: Insulated metal ClicFix bit holder locks all slimBits reliability.

Only for 6 mm slimBits.

Bits: High-quality chrome vanadium steel, through-hardened, bronzed. Protective insulation moulded directly onto the bit and completely integrated into the bit in the lower area.

Individually tested protective insulation 1,000 V AC, VDE and GS tested.

Bit holder: Wiha SoftFinish® electric multi-component handle with roll-off protection. Compact screwdriver together with slimBits.

Application: For all work on or around electrical components up to 1,000 V AC.

Extra: The integrated protective insulation enables low-lying fastening and spring elements to be reached and manipulated. The slim form of the bit allows easy reaching of the screws below the finger and hand guards.

Order-No.	Series				
34733	2831 T701	1			
	⓪ 2831-10	1x3.0	1x4.0	1x5.5	1x6.5
	⊕ 2831-11	1xPH1	1xPH2		
	2831-00	1xSoftFinish® electric slimVario Bithalter			



1000 V  
IEC 60900:2012

### 2831 T702 SoftFinish® electric slimVario starter pack, slotted/ Phillips, 7 pcs.

Order-No.	Series				
34734	2831 T702	1			
	⓪ 2831-10	1x2.5	1x3.0	1x4.0	1x5.5
	⊕ 2831-11	1xPH1	1xPH2		
	2831-00	1xSoftFinish® electric slimVario Bithalter			



1000 V  
IEC 60900:2012

### 2831 T703 SoftFinish® electric slimVario starter pack, slotted/ Xeno (slotted/ Pozidriv), 7 pcs.

Order-No.	Series				
34735	2831 T703	1			
	⓪ 2831-10	1x3.0	1x4.0	1x5.5	1x6.5
	⊕ 2831-14	1xSL/PZ1	1xSL/PZ2		
	2831-00	1xSoftFinish® electric slimVario Bithalter			



**Safety Notice:**

When working with VDE tools, observe the national safety and accident prevention regulations!

**slimVario display.**

**2831 T701 VB** Display SoftFinish® electric slimVario.  
Card display with 7 pcs.

Order-No.	Series				
35556	2831 T701 VB	1			
	⓪ 2831-10	1x3.0	1x4.0	1x5.5	1x6.5
	⊕ 2831-11	1xPH1	1xPH2		
	2831-00	1xSoftFinish® electric slimVario bit holder with handle			



**2831 T702 VB** Display SoftFinish® electric slimVario.  
Card display with 7 pcs.

Order-No.	Series				
35557	2831 T702 VB	1			
	⓪ 2831-10	1x2.5	1x3.0	1x4.0	1x5.5
	⊕ 2831-11	1xPH1	1xPH2		
	2831-00	1xSoftFinish® electric slimVario Bithalter			



**2831 T703 VB** Display SoftFinish® electric slimVario.  
Card display with 7 pcs.

Order-No.	Series				
35558	2831 T703 VB	1			
	⓪ 2831-10	1x3.0	1x4.0	1x5.5	1x6.5
	⊗ 2831-14	1xSL/PZ1	1xSL/PZ2		
	2831-00	1xSoftFinish® electric slimVario Bithalter			

**slimVario display.**

**NEW**  
**2831 VB1** Display SoftFinish® electric slimVario.  
Acryl glass display with 60 pcs.

Size: 22 x 19 x 35 cm (WxDxH).

Order-No.	Series				
37057	2831 VB1	1			
	2831-00	3xSoftFinish® electric slimVario bit holder with handle			
	⓪ 2831-10	5x2.5	4x3.0	4x4.0	4x5.5
	⊕ 2831-11	4xPH1	4xPH2		
	⊗ 2831-12	4xPZ1	4xPHZ2		
	⊗ 2831-14	8xSL/PZ1	8xSL/PZ2		
	2831-15	4xT15	4xT20		



Blades up to **33%**  
narrower due to  
integrated  
insulation.

- Unlimited accessibility
- VDE and GS tested
- Maximum safety



# Wiha SoftFinish® electric slimVario.

Maximum safety at minimum size.

## SoftFinish® electric slimVario sets.



1000 V  
IEC 60900:2012

**2831 T704** slimVario starter set, 7-pcs.  
Important slimBits in a bag.  
Slotted/ Phillips.

Handle: Wiha SoftFinish® electric multi-component handle with roll-off protection.  
Bit holder: Insulated metal ClicFix bit holder locks all slimBits reliability.  
Only for 6 mm slimBits.  
Bits: High-quality chrome vanadium steel, through-hardened, bronzed.  
Protective insulation moulded directly onto the bit and completely integrated into the bit in the lower area.  
Individually tested protective insulation 1,000 V AC, VDE and GS tested.  
Application: For all work on or around electrical components up to 1,000 V AC.  
Extra: Effortless access to low-lying fastening elements. Arranged clearly in a high quality, rugged and durable bag.

Order-No.	Series	
36069	2831 T704	1
	2831-00	1xSoftFinish® electric slimVario bit holder with handle
	Ⓢ 2831-10	1x2.5 1x3.0 1x4.0 1x5.5
	⊕ 2831-11	1xPH1 1xPH2



1000 V  
IEC 60900:2012

**2831 T705** slimVario starter set, 7-pcs.  
Important slimBits in a bag.  
Slotted/ Pozidriv.

Order-No.	Series	
36070	2831 T705	1
	2831-00	1xSoftFinish® electric slimVario bit holder with handle
	Ⓢ 2831-10	1x2.5 1x3.0 1x4.0 1x5.5
	⊕ 2831-12	1xPZ1 1xPZ2

**2831 TL** slimVario bag, empty.

Order-No.	Series	
36326	2831 TL	1



**Safety Notice:**  
When working with VDE tools, observe the national safety and accident prevention regulations!

## SoftFinish® electric slimVario sets.



1000 V  
IEC 60900:2012

**2831 T16** slimVario starter set, 16-pcs.  
All commonly used slimBits in a bag.  
Slotted/ Phillips/ Pozidriv/ Pozidriv Xeno/ TORX®.  
Extra: Single-pole SoftFinish® voltage tester, 110-250 volts.

Order-No.	Series	
36068	2831 T16	1
	2831-00	1xSoftFinish® electric slimVario bit holder with handle
	Ⓢ 255-11L	1xSingle-pole voltage tester, 110-250 volts
	Ⓢ 2831-10	1x2.5 1x3.0 1x4.0 1x5.5
	⊕ 2831-11	1xPH1 1xPH2
	⊕ 2831-12	1xPZ1 1xPZ2
	⊕ 2831-14	1xSL/PZ1 1xSL/PZ2
	⊕ 2831-15	1xT10 1xT15 1xT20 1xT25



1000 V  
IEC 60900:2012

**2872 T10** slim selection set, 10-pcs.  
VDE complete set with torque screwdriver, bit holder and slimBits.  
Slotted/ Phillips/ Pozidriv.  
Handle: VDE torque handle 1.0 - 5.0 Nm, steplessly adjustable.  
Bit holder: Insulated metal ClicFix bit holder locks all slimBits reliability.  
Only for 6 mm slimBits.  
Bits: Protective insulation moulded directly onto the bit and completely integrated into the bit in the lower area.  
Individually tested protective insulation 1,000 V AC, VDE and GS tested.  
Application: For controlled fastening on live parts up to 1 000 V AC.  
Extra: 100% safety from fastening with torque according to specification of manufacturer type-tested switching devices according to EN 60439-1. Effortless access to low-lying fastening elements. Arranged clearly in a high quality, rugged and durable bag.

Order-No.	Series	
36078	2872 T10	1
	2872	1xTorqueVario®-S VDE, model 1.0-5.0 Nm
	2831-00	1xSoftFinish® electric slimVario bit holder with handle
	2879	1xslimTorque VDE bit holder for 6 mm slimBits
	285-900	1xTorque-Setter
	Ⓢ 2831-10	1x4.0 1x5.5
	⊕ 2831-11	1xPH1 1xPH2
	⊕ 2831-12	1xPZ1 1xPZ2

# Wiha SoftFinish® electric.

The safe and comfortable insulated VDE screwdriver.



The right tool at a glance, thanks to the printed screw symbol on the handle end.



## For slotted screws.



**320N**

SoftFinish® electric slotted screwdriver.

Individually tested protective insulation 1,000 V AC, VDE and GS tested.

Blade: High quality chrome-vanadium-molybdenum steel, through hardened, black-finish. Insulation moulded directly onto blade.

Handle: Ergonomic Wiha SoftFinish® multi-component handle with roll-off protection.

Standards: DIN ISO 2380. Manufactured acc. to IEC 60900:2012.

Application: For all work on or around electrical components up to 1,000 V AC.

Order-No.	①	↔	②	↔	↔	↔
00819	2.0	60	0.4	164	23	10
00820	2.5	75	0.4	179	23	10
00821	3.0	100	0.5	204	23	10
00822	3.5	100	0.6	204	23	10
00823	4.0	100	0.8	211	30	10
00824	4.5•	125	1.0	236	30	10
00825	4.5•	175	1.0	286	30	5
31863	4.5•	200	1.0	311	30	10
00826	5.5	125	1.0	243	36	10
00827	5.5•	175	1.0	293	36	5
00828	6.0•	150	1.2	268	36	10
00829	6.5	150	1.2	268	36	10
00830	8.0	175	1.2	299	41	10
00831	8.0	175	1.6	299	41	10
00832	10.0	200	1.6	324	41	10

• Additional dimension. Non-DIN size.



**Wiha SoftFinish® electric.**

- Safety when working with live equipment up to 1,000 V AC and 1,500 V DC
- Each screwdriver is individually tested in a water bath at 10,000 volts according to IEC 60900:2012
- Awarded the GS symbol for tested safety
- Multi-component SoftFinish® handle provides maximum user comfort

Applications on live equipment are subject to very special requirements. The focus is on absolute user safety and Wiha demonstrates this with a wealth of details.

The high quality blade insulation is moulded directly onto the blade and therefore guarantees safety when working on live equipment up to 1,500 V DC / 1,000 V AC. To maintain this safety, each screwdriver of the SoftFinish® electric series is individually tested in a water bath at 10,000 Volts according to IEC 60900:2012.

The roll-off protection and the special handle geometry offer optimum handling and electrical safety, even in critical applications.

# Wiha SoftFinish® electric.

The safe and comfortable insulated VDE screwdriver.

## For Phillips, Pozidriv and TORX® screws.



1000 V  
IEC 60900:2012

**321N** SoftFinish® electric Phillips screwdriver.  
Individually tested protective insulation  
1,000 V AC, VDE and GS tested.

Blade: High quality chrome-vanadium-molybdenum steel, through hardened, black-finish.

Insulation moulded directly onto blade.

Handle: Ergonomic Wiha SoftFinish® multi-component handle with roll-off protection.

Standards: DIN ISO 8764. Manufactured acc. to IEC 60900:2012.

Application: For all work on or around electrical components up to 1,000 V AC.

Order-No.	PH	PZ	TORX	Other	
00846	PH0	60	164	23	10
00847	PH1	80	191	30	10
00848	PH2	100	218	36	10
00849	PH3	150	268	41	10
00850	PH4	200	318	41	5



1000 V  
IEC 60900:2012

**324** SoftFinish® electric Pozidriv screwdriver.  
Individually tested protective insulation  
1,000 V AC, VDE and GS tested.

Blade: High quality chrome-vanadium-molybdenum steel, through hardened, black-finish.

Insulation moulded directly onto blade.

Handle: Ergonomic Wiha SoftFinish® multi-component handle with roll-off protection.

Standards: DIN ISO 8764. Manufactured acc. to IEC 60900:2012.

Application: For all work on or around electrical components up to 1,000 V AC.

Order-No.	PZ	TORX	Other		
00877	PZ0	60	164	23	10
00878	PZ1	80	191	30	10
00879	PZ2	100	218	36	10
00880	PZ3	150	324	41	5



1000 V  
IEC 60900:2012

**325** SoftFinish® electric TORX® screwdriver.  
Individually tested protective insulation  
1,000 V AC, VDE and GS tested.

Blade: High quality chrome-vanadium-molybdenum steel, through hardened, black-finish.

Insulation moulded directly onto blade.

Handle: Ergonomic Wiha SoftFinish® multi-component handle with roll-off protection.

Standards: Manufactured acc. to IEC 60900:2012.

Application: For all work on or around electrical components up to 1,000 V AC.

Extra: Sizes T10 to T40 are in the 3251 series with the slimFix screwdrivers.

Order-No.	T	Other
03760	T5	60 164 23 10
03761	T6	60 164 23 10
03762	T7	60 164 23 10
00881	T8	60 164 23 10
00882	T9	60 164 23 10

## For allen screws and internal square-drive screws.



1000 V  
IEC 60900:2012

**322** SoftFinish® electric hex nut driver.  
Individually tested protective insulation  
1,000 V AC, VDE and GS tested.

Blade: Chrome-vanadium steel, through hardened, black-finish.  
Insulation moulded directly onto blade.

Deep drawn socket.

Handle: Ergonomic Wiha SoftFinish® multi-component handle with roll-off protection.

Standards: DIN 3125. Manufactured acc. to IEC 60900:2012.

Application: For external hex screws and hex nuts.

Order-No.	Hex	Other
00853	4	125 236 30 10.2 10
00855	5	125 236 30 11.2 10
00856	5.5	125 236 30 11.2 10
00857	6	125 236 30 12.2 10
00858	7	125 243 36 14.5 10
00859	8	125 243 36 15.2 10
00860	9	125 243 36 16.0 10
00861	10	125 243 36 17.2 10
00862	11	125 243 41 19.2 5
00863	12	125 243 41 20.2 5
00864	13	125 243 41 22.2 5
00865	14	125 243 41 23.2 5
00866	15	125 243 41 25.2 5
00867	16	125 243 41 25.2 5
00868	17	125 243 41 27.2 5



1000 V  
IEC 60900:2012

**323N** SoftFinish® electric hex screwdriver.  
Individually tested protective insulation  
1,000 V AC, VDE and GS tested.

Blade: Chrome-vanadium steel, through hardened, black-finish.  
Insulation moulded directly onto blade.

Handle: Ergonomic Wiha SoftFinish® multi-component handle with roll-off protection.

Standards: Manufactured acc. to IEC 60900:2012.

Application: For allen screws.

Order-No.	Hex	Other
30361	2.5	75 179 23 10
30362	3.0	75 179 23 10
30363	4.0	75 186 30 10
30364	5.0	75 186 30 10
30365	6.0	100 218 36 10
30366	8.0	100 218 36 10



1000 V  
IEC 60900:2012

**358N** SoftFinish® electric square (Robertson) screwdriver.  
Individually tested protective insulation  
1,000 V AC, VDE and GS tested.

Blade: High quality chrome-vanadium-molybdenum steel, through hardened, black-finish. Insulation moulded directly onto blade.

Handle: Ergonomic Wiha SoftFinish® multi-component handle with roll-off protection.

Standards: Manufactured acc. to IEC 60900:2012.

Application: For fastening and unfastening internal square-drive (Robertson) screws.

Order-No.	Robertson	Other
32396	Robertson 1	2.3 100 211 30 10
32397	Robertson 2	2.8 150 268 36 10



**Safety Notice:**

When working with VDE tools, observe the national safety and accident prevention regulations!



**Slotted/ Phillips and slotted/ Pozidriv sets.**



1000 V  
IEC 60900:2012

**320N K6** SoftFinish® electric slotted/ Phillips screwdriver set, 6 pcs.  
Individually tested protective insulation  
1,000 V AC, VDE and GS tested.

- Blade: High quality chrome-vanadium-molybdenum steel, through hardened, black-finish. Insulation moulded directly onto blade.
- Handle: Ergonomic Wiha SoftFinish® multi-component handle with roll-off protection.
- Standards: Manufactured acc. to IEC 60900:2012.
- Application: For all work on or around electrical components up to 1,000 V AC.

Order-No.	Series				
00833	320N K6				1
⓪	320N	3.0x100	4.0x100	5.5x125	6.5x150
⊕	321N	PH1x80	PH2x100		

**Slotted/Phillips- and nut driver set.**



1000 V  
IEC 60900:2012

with  
voltage tester

**320N K7** SoftFinish® electric slotted/ Phillips screwdriver set, 7 pcs.  
Individually tested protective insulation  
1,000 V AC, VDE and GS tested.

- Blade: High quality chrome-vanadium-molybdenum steel, through hardened, black-finish. Insulation moulded directly onto blade.
- Handle: Ergonomic Wiha SoftFinish® multi-component handle with roll-off protection.
- Standards: Manufactured acc. to IEC 60900:2012.
- Application: For all work on or around electrical components up to 1,000 V AC.

Order-No.	Series				
00834	320N K7				1
⓪	320N	2.5x75	4.0x100	5.5x125	6.5x150
⊕	321N	PH1x80	PH2x100		
⓪	255-11L	3.0x60			



1000 V  
IEC 60900:2012

**320N ZK6 SO** SoftFinish® electric slotted/ Pozidriv screwdriver set, 6 pcs.  
Individually tested protective insulation 1,000 V AC, VDE and GS tested.

- Blade: High quality chrome-vanadium-molybdenum steel, through hardened, black-finish. Insulation moulded directly onto blade.
- Handle: Ergonomic Wiha SoftFinish® multi-component handle with roll-off protection.
- Standards: Manufactured acc. to IEC 60900:2012.
- Application: For all work on or around electrical components up to 1,000 V AC.

Order-No.	Series				
25477	320N ZK6 SO				1
⓪	320N	2.5x75	3.5x100	4.5x125	5.5x125
⊕	324	PZ1x80	PZ2x100		



1000 V  
IEC 60900:2012

**322 K5** SoftFinish® electric hex nut driver set, 5 pcs.  
Individually tested protective insulation  
1,000 V AC, VDE and GS tested.

- Blade: Chrome-vanadium steel, through hardened, black-finish. Insulation moulded directly onto blade. Deep drawn socket.
- Handle: Ergonomic Wiha SoftFinish® multi-component handle with roll-off protection.
- Standards: Manufactured acc. to IEC 60900:2012.
- Application: For all work on or around electrical components up to 1,000 V AC.

Order-No.	Series				
29466	322 K5				1
⓪	322	5.5x125	7x125	8x125	10x125
		13x125			



# Wiha SoftFinish® electric Xeno.

For terminal screws.



The SoftFinish® electric Xeno screwdriver is a special VDE screwdriver used to turn terminal screws. Terminal screws are typically used in switch-cabinet systems and fuse boxes, terminal blocks and relays.

They have a special combination profile and are available as slotted/Phillips or slotted/Pozidriv models.



The Wiha SoftFinish® electric Xeno is ideally suited for work on switch cabinet systems, fuse boxes, terminal strips and relays.



## Wiha SoftFinish® electric Xeno.

- The special slotted/ Phillips or slotted/ Pozidriv profile of the Xeno is optimally suited for terminal screws
- The combination profile reduces slipping and ensures greater torque transfer





**Safety Notice:**

When working with VDE tools, observe the national safety and accident prevention regulations!



**For terminal screws (slotted/ Phillips).**

**For terminal screws (slotted/ Pozidriv).**



1000 V IEC 60900:2012

1000 V IEC 60900:2012

**327** SoftFinish® electric Xeno.  
**For terminal screws (slotted/ Phillips).**  
 Individually tested protective insulation 1,000 V AC, VDE and GS tested.  
 Blade: High quality chrome-vanadium-molybdenum steel, through hardened, black-finish.  
 Insulation moulded directly onto blade.  
 Handle: Ergonomic Wiha SoftFinish® multi-component handle with roll-off protection.  
 Standards: Manufactured acc. to IEC 60900:2012.  
 Application: For all work on or around electrical components up to 1,000 V AC. No slipping and better torque transfer with terminal screws e.g. in switch-cabinets, fuse boxes and terminal blocks.

**328** SoftFinish® electric Xeno.  
**For terminal screws (slotted/ Pozidriv).**  
 Individually tested protective insulation 1,000 V AC, VDE and GS tested.  
 Blade: High quality chrome-vanadium-molybdenum steel, through hardened, black-finish.  
 Insulation moulded directly onto blade.  
 Handle: Ergonomic Wiha SoftFinish® multi-component handle with roll-off protection.  
 Standards: Manufactured acc. to IEC 60900:2012.  
 Application: For all work on or around electrical components up to 1,000 V AC. No slipping and better torque transfer with terminal screws e.g. in switch-cabinets, fuse boxes and terminal blocks.

Order-No.	⊕	↔	↔	↔	↔
30716	SL/PH1	80	191	30	10
30715	SL/PH2	100	218	36	10

Order-No.	⊕	↔	↔	↔	↔
30700	SL/PZ1	80	191	30	10
30701	SL/PZ2	100	218	36	10



1000 V IEC 60900:2012



1000 V IEC 60900:2012

**SB 327 S2** SoftFinish® electric Xeno screwdriver set, 2 pcs.  
**For terminal screws (slotted/ Phillips).**  
 Individually tested protective insulation 1,000 V AC, VDE and GS tested.  
**Blister packed.**  
 Blade: High quality chrome-vanadium-molybdenum steel, through hardened, black-finish.  
 Insulation moulded directly onto blade.  
 Handle: Ergonomic Wiha SoftFinish® multi-component handle with roll-off protection.  
 Standards: Manufactured acc. to IEC 60900:2012.  
 Application: For all work on or around electrical components up to 1,000 V AC.

**SB 328 S2** SoftFinish® electric Xeno screwdriver set, 2 pcs.  
**For terminal screws (slotted/ Pozidriv).**  
 Individually tested protective insulation 1,000 V AC, VDE and GS tested.  
**Blister packed.**  
 Blade: High quality chrome-vanadium-molybdenum steel, through hardened, black-finish.  
 Protective insulation moulded directly onto the blade.  
 Handle: Ergonomic Wiha SoftFinish® multi-component handle with roll-off protection.  
 Standards: Manufactured acc. to IEC 60900:2012.  
 Application: For all work on or around electrical components up to 1,000 V AC.

Order-No.	Series	↔
32281	SB 327 S2	1
⊕	327	SL/PH1x80 SL/PH2x100

Order-No.	Series	↔
32282	SB 328 S2	1
⊕	328	SL/PZ1x80 SL/PZ2x100

# Wiha Topra 2K electric.

Pure power for electrical applications.



Finely serrated ratchet with 72 teeth enables 5° switching angle: guarantees precise work when things get tight.



The turbo wheel in use

The new Topra 2K electric pistol handle for electrical applications is especially advisable whenever large screwed connections have to be fastened. This is because the transmission of force can be axial when using a tool of this type due to its shape, and because the lever arm can be used to produce up to 20 Nm torque comfortably. This handle geometry is supported by a finely serrated ratchet with 72 teeth which enables a small switching angle of just 5°. In connection with the very low range of motion, all screwed connections (from the smallest to the largest) can be moved, even in extremely tight spaces.

The soft and hard zones are distributed across the handle according to the grip requirements of the hand and fingers in order to optimise the transmission of force to the handle. Thanks to the ergonomic design of this tool, it can be used to work with either a 2-finger grip or a hand clasp:

- **2-finger grip** when work has to be done quickly, e.g. when fastening long screws
- **Hand clasp** when the tightening or loosening requires increased torques.

Equipped with the special VDE blades, this tool fulfils the most demanding requirements of IEC 60900:2012



## Wiha Topra 2K electric.

- **Powerful:**  
Ergonomic pistol handle for high torques.
- **Without losses:**  
Axial transmission of forces – without breakdown torque
- **Comfortable:**  
Maximum transmission of force due to soft and hard zones which are adapted to the users palm
- **Fast:**  
Finely serrated ratchet with 72 teeth enables 5° switching angle which works precisely when things get tight.
- **Innovative:**  
Turbo wheel for fast turning of metal screws



**Safety Notice:**

When working with VDE tools, observe the national safety and accident prevention regulations!

**Topra 2K electric pistol ratchet.****NEW**
**282700****Topra 2K electric pistol ratchet.**

For individually tested VDE torque blades of the 28379 series.

Blade: Designed for all blades of the 28379 series.

Positive locking secures all blades perfectly.

Handle: Ergonomic pistol handle for high torques.

Axial power transmission without breakdown torque.

Maximum transmission of force due to soft and hard zones which are adapted to the users palm.

Finely serrated ratchet with 72 teeth enables 5° switching angle: guarantees precise work when things get tight.

Low range of motion for quick work, e.g. in 2-finger access.

Turbo wheel for extremely fast turning of metal screws and bolts.

Application: Fast and powerful fastening even of larger screws, e.g. M8 and M10 in the area of live parts up to 1,000 V AC.

Order-No.	Ø	↔	↔	↔
39069	6.0	107	121	5

**Topra 2K electric blades.****NEW**
**28379****Torque TR electric interchangeable blade, TORX®.**

Individually tested protective insulation 1,000 V AC, VDE and GS tested.

Blade: High quality chrome-vanadium-molybdenum steel, through hardened, black-finish. Insulation moulded directly onto blade and completely integrated into the blade in the lower area.

Standards: Manufactured according to IEC 60900:2012.

Application: For all work on or around electrical components up to 1,000 V AC.

Order-No.	Ø	↔	↔	max. Nm	↔
38931	T15	132	35	6.6	10
38932	T20	132	35	13	10
38933	T25	132	35	15	10
38934	T27	132	35	15	10
38935	T30	132	35	20	10
38936	T40	132	35	20	10

**NEW**
**28379****Torque TR electric interchangeable blade, hex.**

Individually tested protective insulation 1,000 V AC, VDE and GS tested.

Blade: High quality chrome-vanadium-molybdenum steel, through hardened, black-finish. Insulation moulded directly onto blade and completely integrated into the blade in the lower area.

Standards: Manufactured according to IEC 60900:2012.

Application: For all work on or around electrical components up to 1,000 V AC.

Order-No.	Ø	↔	↔	max. Nm	↔
38918	3.0	132	35	5.5	10
38919	4.0	132	35	15	10
38920	5.0	132	35	20	10
38921	6.0	132	35	20	10

**NEW**
**28379****Torque TR electric interchangeable blade, hex nut driver.**

Individually tested protective insulation 1,000 V AC, VDE and GS tested.

Blade: High quality chrome-vanadium-molybdenum steel, through hardened, black-finish. Insulation moulded directly onto blade and completely integrated into the blade in the lower area.

Standards: Manufactured according to IEC 60900:2012.

Application: For all work on or around electrical components up to 1,000 V AC.

Order-No.	Ø	↔	max. Nm	↔
38925	7.0	132	5	10
38926	8.0	132	10	10
38927	9.0	132	14	10
38928	10.0	132	17	10
38929	13.0	132	20	10
38930	17.0	132	20	10

# Wiha Classic electric.

The classic for electrical applications.



**Safety Notice:**  
When working with VDE tools, observe the national safety and accident prevention regulations!

## For slotted and Phillips screws.



**320** Classic electric slotted screwdriver.  
Individually tested protective insulation 1,000 V AC, VDE and GS tested.

Blade: Chrome-vanadium steel, through hardened, black-finish.  
Insulation moulded directly onto blade.  
Handle: Impact resistant Wiha Classic handle, resistant to chemicals and oils.  
Standards: DIN ISO 2380. Manufactured acc. to IEC 60900:2012.  
Application: For all work on or around electrical components up to 1,000 V AC.

Order-No.	⌀	↔	↔	↔	↔	↔
00782	1.6	40	0.4	115	19	10
00783	2.3	60	0.5	135	19	10
00784	2.5	75	0.4	150	19	10
00785	2.8	75	0.6	150	19	10
00786	3.0•	100	0.5	175	19	10
06568	3.0	150	0.5	225	19	10
00787	3.5	100	0.6	185	22	10
00788	3.5	100	0.8	185	22	10
00789	4.0	100	0.8	195	24	10
06569	4.0	150	0.8	245	24	10
00790	4.5	125	1.0	220	24	10
00791	4.5•	175	1.0	270	24	10
06570	5.0	100	1.0	195	24	10
06571	5.0	150	1.0	245	24	10
00792	5.5	125	1.0	230	28	10
00793	5.5•	175	1.0	280	28	10
06573	6.0	100	1.2	205	28	10
00794	6.0	150	1.2	255	28	10
00795	6.5	150	1.2	255	28	10
00796	8.0	175	1.2	290	32	10
00797	10.0	200	1.6	325	36	10

• Additional dimension. Non-DIN size.



**321** Classic electric Phillips screwdriver.  
Individually tested protective insulation 1,000 V AC, VDE and GS tested.

Blade: Chrome-vanadium steel, through hardened, black-finish.  
Insulation moulded directly onto blade.  
Handle: Impact resistant Wiha Classic handle, resistant to chemicals and oils.  
Standards: DIN ISO 8764. Manufactured acc. to IEC 60900:2012.  
Application: For all work on or around electrical components up to 1,000 V AC.

Order-No.	⊕	↔	↔	↔	↔
00836	PH0	60	135	19	10
00837	PH1	80	175	24	10
00838	PH2	100	205	28	10
00839	PH3	150	265	32	10
00840	PH4	200	325	36	10

## VDE slotted/ Phillips sets.



**320 K6** Classic electric slotted/Phillips screwdriver set, 6 pcs.  
Individually tested protective insulation 1,000 V AC, VDE and GS tested.

Blade: Chrome-vanadium steel, through hardened, black-finish.  
Insulation moulded directly onto blade.  
Handle: Impact resistant Wiha Classic handle, resistant to chemicals and oils.  
Standards: Manufactured acc. to IEC 60900:2012.  
Application: For all work on or around electrical components up to 1,000 V AC.

Order-No.	Series	↔
00815	320 K6	1
⌀	320	2.8x75 4.0x100 5.5x125 6.5x150
⊕	321	PH1x80 PH2x100



**320 P7 S0** Classic electric slotted/Phillips screwdriver set, 7 pcs.  
Individually tested protective insulation 1,000 V AC, VDE and GS tested.

Blade: Chrome-vanadium steel, through hardened, black-finish.  
Insulation moulded directly onto blade.  
Handle: Impact resistant Wiha Classic handle, resistant to chemicals and oils.  
Standards: Manufactured acc. to IEC 60900:2012.  
Application: For all work on or around electrical components up to 1,000 V AC.

Order-No.	Series	↔
07151	320 P7 S0	1
⌀	320	2.8x75 4.0x100 5.5x125 6.5x150
⊕	321	PH1x80 PH2x100
⌀	255-3L	3.0x60

with voltage tester



# Wiha PicoFinish electric.

The VDE-GS tested precision screwdriver.



The smooth-running turn-cap enables fast turning.

Imprint with the screw symbol and sizes eases recognition.



## Wiha PicoFinish electric.



**NEW** 2270P PicoFinish electric slotted screwdriver.

Handle with rotating cap and rapid-turning zone.  
Individually tested protective insulation  
1,000 V AC, VDE and GS tested.

Blade: High quality chrome-vanadium-molybdenum steel, through hardened, black-finish. Insulation moulded directly onto blade.

Handle: Wiha PicoFinish handle for sensitive and fast screw fixing.

Standards: DIN ISO 2380. Manufactured acc. to IEC 60900:2012.

Application: For all work on or around electrical components up to 1,000 V AC.

Order-No.	⌀	↔	⊖	●	↔	↔	↔
38874	1.5	40	0.25	2.0	154	9	10
38875	2.0	60	0.4	2.0	160	18	10
38876	2.5	60	0.4	2.5	160	18	10
38877	3.0	60	0.5	3.0	160	18	10
38878	3.5	60	0.6	3.5	160	18	10



## Wiha PicoFinish electric.

The new ergonomic Wiha PicoFinish electric precision screwdriver has protective insulation on the bronzed blade which is certified in accordance with VDE-GS and individually tested for breakdown in a water bath at 10,000 V. Because of this, this new family expands the application possibilities of VDE-GS tested fastening tools with tools for smaller screw sizes. These are necessary especially when settings should be made on live electrical or electronic components. Sensitive turning is particularly easy due to its octagonal profile at the beginning of the quick-turning zone.

A further advantage: This tool eliminates the risk of accidentally touching live parts with a blank blade and causing a short circuit.

- Ergonomic handle design with soft zone for comfortable work
- Through hardened, bronzed blade of chrome-vanadium-molybdenum steel for a long lifespan
- Protective insulation spray-coated directly onto the blade
- Safety when working with live equipment up to 1,000 V AC and 1,500 V DC
- Each screwdriver is individually tested in a water bath at 10,000 volts according to IEC 60900:2012
- Ideal for all fine and delicate work in electrical engineering and electronics



**NEW** 2271P PicoFinish electric Philips screwdriver.

Handle with rotating cap and rapid-turning zone.  
Individually tested protective insulation  
1,000 V AC, VDE and GS tested.

Blade: DIN ISO 8764.

Order-No.	⊕	↔	●	↔	↔	↔
38879	PH00	60	2.0	154	9	10
38880	PH0	60	3.0	160	18	10
38881	PH1	60	4.0	160	18	10



**NEW** 2270P K6 PicoFinish electric slotted/Phillips screwdriver set, 6-pcs.

Individually tested protective insulation  
1,000 V AC, VDE and GS tested.

Order-No.	Series				
38996	2270P K6	1			
⊖	2270P	1.5x40	2.0x60	2.5x60	3.0x60
⊕	2271P	PH00x60	PH0x60		

# Wiha Volt Detector.

Testing pen for AC voltages.



The testing pen detects the phase and neutral conductor



Press down the clip, and the battery compartment locking mechanism opens



## Wiha Volt Detector.

The Wiha Volt Detector is a measuring device to test the presence of AC voltage safely. For this purpose, the white tip is guided to the wire or contact to be tested. If the sensor detects AC voltage within a field of 4 mm, the red LED lights up immediately.

A particular advantage is that this test can be performed without having to disconnect or open cables, mains sockets, fuses, circuit breakers, junction boxes, etc.

A current flow through the user's body is not necessary for the reliable use of the testing pen. The power for operating the red LED is provided by 2 AAA batteries (LR03) that are included in the delivery

- Testing pen detects AC voltages from 230 to 1,000 V AC
- A bright red LED indicates AC voltages
- A current flow through the user's body is not necessary
- Complies with IEC 61010-1 safety standard: Measuring category CAT III 1,000 V
- CE compliant.

## Volt Detector.



**NEW**  
**255-12**



**Volt Detector: Non-contact measuring voltage tester for AC voltages from 230 to 1,000 VAC.**

- Scale: Bright red LED.
- Handle: Handy plastic housing with removable cap. Practical clip.
- Torque transducer: Protected under the white tip, the sensor provides non-contact recognition of AC voltages within a field of 4 mm.
- Standards: IEC 61010-1
- Measuring category: CAT III 1,000 VAC.
- Application: For determining AC voltages in the low voltage range between 230 and 1,000 VAC.
- Extra: 2 AAA batteries (LR03) are inserted in the voltage tester.

Order-No.	●!	↔	↔	↔
37871	4.2	149	39	10

**NEW**  
**SB 255-12**



**Volt Detector: Non-contact measuring voltage tester for AC voltages from 230 to 1,000 VAC. Blister packed.**

Order-No.	●!	↔	↔	↔
37872	4.2	149	39	5

# Wiha single-pole voltage tester.

## SoftFinish® voltage tester.



### 255-11 Single-pole SoftFinish® voltage tester, 110-250 volts.

In accordance with DIN 57680/-6 and VDE 0680-6, GS tested, CE compliant.

Blade: High-quality chrome-vanadium molybdenum steel, through-hardened, nickel-coated. Insulation moulded directly onto blade.

Handle: Ergonomic Wiha SoftFinish® handle of transparent, impact resistant plastic.

Metal contact plate and robust clip.

Standards: Blade tip DIN ISO 2380-1.

Application: For determining alternating voltages in low voltage range up to 250 volts with respect to earth potential.

Suitable for trade and industry professionals.

Extra: Tried-and-proven Wiha SoftFinish® screwdriver with additional testing function.

Global use is assured.

Order-No.	⌀	↔	⊖	↔	⊕	⊞
34745	3.0	60	0.5	140	19	10

### SB 255-11 Single-pole SoftFinish® voltage tester 110-250 volts.

In accordance with DIN 57680/-6 and VDE 0680-6, GS tested, CE compliant. Blister packed.

Order-No.	⌀	↔	⊖	↔	⊕	⊞
35378	3.0	60	0.5	140	19	5

## Wiha Info

### Wiha SoftFinish® as single-pole voltage tester.

- High quality, hardened chrome-vanadium-molybdenum blade for perfect fastening
- Quality screwdriver in Wiha SoftFinish® design with testing function
- Voltage testing function with respect to earth potential from 110 to 250 V: worldwide use possible
- Rugged spring clip of non-rusting stainless steel
- Solid brass earthing contact
- VDE and GS tested
- CE compliant



### Safety Notice:

When working with VDE tools, observe the national safety and accident prevention regulations!

## Single-pole voltage tester.



### 255-2 Single-pole voltage tester, 220-250 volts.

In accordance with DIN 57680/-6 and VDE 0680-6, GS tested, CE compliant.

Blade: Chrome vanadium steel, through-hardened, nickel-coated.

Handle: Transparent.

Application: For determining alternating voltages in low voltage range up to 250 volts with respect to earth potential.

Suitable for trade and industry professionals.

Order-No.	⌀	↔	↔	⊕	⊞
05270	3.5	107	195	18	10

### SB 255-2 Single-pole voltage tester 220-250 volts.

In accordance with DIN 57680/-6 and VDE 0680-6, GS tested, CE compliant.

Blister packed.

Order-No.	⌀	↔	↔	⊕	⊞
36517	3.5	107	195	18	5



### 255-3 Single-pole voltage tester, 220-250 volts.

In accordance with DIN 57680/-6 and VDE 0680-6, GS tested, CE compliant.

Blade: Chrome vanadium steel, through-hardened, nickel-coated.

Handle: Transparent with clip.

Application: For determining alternating voltages in low voltage range up to 250 volts with respect to earth potential.

Suitable for trade and industry professionals.

Order-No.	⌀	↔	↔	⊕	⊞
05271	3.0	60	140	15	10

### SB 255-3 Single-pole voltage tester 220-250 volts.

In accordance with DIN 57680/-6 and VDE 0680-6, GS tested, CE compliant. Blister packed.

Order-No.	⌀	↔	↔	⊕	⊞
32201	3.0	60	140	15	1



### 255-7 Single-pole voltage tester, 150 - 250 volts.

In accordance with DIN 57680/-6 and VDE 0680-6, GS tested, CE compliant.

Blade: Chrome-vanadium steel, through hardened, black-finish.

Handle: Black with clip.

Application: For determining alternating voltages in low voltage range up to 250 volts with respect to earth potential.

Suitable for trade and industry professionals.

Order-No.	⌀	↔	↔	⊕	⊞
00456	3.0	60	160	17	10

### SB 255-7 Single-pole voltage tester, 150 - 250 volts.

In accordance with DIN 57680/-6 and VDE 0680-6, GS tested, CE compliant. Blister packed.

Order-No.	⌀	↔	↔	⊕	⊞
31771	3.0	60	160	17	1

# Wiha SoftFinish® ESD.

For use on electrostatically sensitive components.



EPA

Wiha SoftFinish® ESD screwdrivers have a surface resistance of  $10^6 - 10^9$  ohms.



The SoftFinish® ESD screwdrivers feature an impressive and ergonomic multi-component handle.

For work on electrostatically sensitive devices and assemblies, there is no better screwdriver than the Wiha SoftFinish® ESD, with integrated soft zone in the multi-component handle. The dissipative handle with a surface resistance of  $10^6 - 10^9$  ohms discharges the electrostatic energy in a controlled manner to protect devices at risk from electrostatic discharge.

The ergonomic handle form was developed from the basis of extensive scientific investigations in cooperation with the Fraunhofer Institute. The result is a multi-component handle with a seamless outer form. Each hand size adapts perfectly to screwdriver, there are no pressure points while working and loading of the finger joints is minimised.



The hard handle core consists of impact resistant polypropylene. The thermoplastic elastomer handle provides for a pleasant, safe and slip-proof grip. The inseparable handle is connected to the core by a moulding process. The high-quality blade of chrome-vanadium- molybdenum steel is through hardened and mattechrome plated. The Wiha ChromTop® blade tip ensures a perfect fit in every screw head.

Wiha SoftFinish® ESD screwdrivers correspond to the internationally specified ESD standards IEC 61340-5-1.



## Wiha SoftFinish® ESD.

- Dissipative handle designed to discharge uniformly, surface resistance  $10^6 - 10^9$  ohms
- Meets ESD standard IEC 61340-5-1
- Ergonomic SoftFinish® multi-component handle guarantees comfortable work and optimised handling
- Blade made of high-quality CVM steel, through hardened and chrome plated
- Wiha ChromTop® blade tip ensure a perfect fit in every screw head





**Safety Notice:**

Wiha ESD screwdrivers are noninsulated, therefore not suitable for working on live parts.



**For slotted, Phillips and Pozidriv screws.**

**For slotted, Phillips and Pozidriv screws.**



**302ESD SoftFinish® ESD slotted screwdriver. Dissipative handle, ESD-safe.**

Blade: High quality chrome-vanadium-molybdenum steel, through hardened, chrome-plated.

Wiha ChromTop® finish on tip for a perfect fit every time.

Handle: Ergonomic Wiha SoftFinish® multi-component handle with roll-off protection.

Surface resistance 10<sup>6</sup> - 10<sup>9</sup> ohms.

Standards: IEC 61340-5-1.

Application: For working on electrostatically sensitive components.

Order-No.	⌀	↔	⊖	●	↔	↔	↔
08179	2.5	75	0.4	2.5	179	23	10
27150	3.0	100	0.5	3.0	204	23	10
27151	4.0	100	0.8	4.0	211	30	10
08182	5.5	125	1.0	5.5	236	30	10
08183	6.5	150	1.2	6.0	268	36	10



**302ESD SoftFinish® ESD slotted screwdriver Stubby. Dissipative handle, ESD-safe.**

Blade: High quality chrome-vanadium-molybdenum steel, through hardened, chrome-plated.

Wiha ChromTop® finish on tip for a perfect fit every time.

Handle: Ergonomic Wiha SoftFinish® multi-component handle with roll-off protection.

Surface resistance 10<sup>6</sup> - 10<sup>9</sup> ohms.

Standards: IEC 61340-5-1.

Application: For working on electrostatically sensitive components.

Order-No.	⌀	↔	⊖	●	↔	↔	↔
32151	4.0	25	0.8	4.0	81	34	10
32152	5.5	25	1.0	5.5	81	34	10
32153	6.5	25	1.2	6.5	81	34	10



**311ESD SoftFinish® ESD Phillips screwdriver. Dissipative handle, ESD-safe.**

Blade: High quality chrome-vanadium-molybdenum steel, through hardened, chrome-plated.

Wiha ChromTop® finish on tip for a perfect fit every time.

Handle: Ergonomic Wiha SoftFinish® multi-component handle with roll-off protection.

Surface resistance 10<sup>6</sup> - 10<sup>9</sup> ohms.

Standards: IEC 61340-5-1.

Application: For working on electrostatically sensitive components.

Order-No.	⊕	↔	●	↔	↔	↔
08184	PH0	60	3.0	164	23	10
08185	PH1	80	4.5	191	30	10
08186	PH2	100	6.0	218	36	10



**311ESD SoftFinish® ESD Phillips screwdriver Stubby. Dissipative handle, ESD-safe.**

Blade: High quality chrome-vanadium-molybdenum steel, through hardened, chrome-plated.

Wiha ChromTop® finish on tip for a perfect fit every time.

Handle: Ergonomic Wiha SoftFinish® multi-component handle with roll-off protection.

Surface resistance 10<sup>6</sup> - 10<sup>9</sup> ohms.

Standards: IEC 61340-5-1.

Application: For working on electrostatically sensitive components.

Order-No.	⊕	↔	●	↔	↔	↔
32154	PH1	25	4.5	81	34	10
32155	PH2	25	6.0	81	34	10



**313ESD SoftFinish® ESD Pozidriv screwdriver. Dissipative handle, ESD-safe.**

Blade: High quality chrome-vanadium-molybdenum steel, through hardened, chrome-plated.

Wiha ChromTop® finish on tip for a perfect fit every time.

Handle: Ergonomic Wiha SoftFinish® multi-component handle with roll-off protection.

Surface resistance 10<sup>6</sup> - 10<sup>9</sup> ohms.

Standards: IEC 61340-5-1.

Application: For working on electrostatically sensitive components.

Order-No.	⊕	↔	●	↔	↔	↔
26928	PZ0	60	3.0	164	23	10
26929	PZ1	80	4.5	191	30	10



**313ESD SoftFinish® ESD Pozidriv screwdriver Stubby. Dissipative handle, ESD-safe.**

Blade: High quality chrome-vanadium-molybdenum steel, through hardened, chrome-plated.

Wiha ChromTop® finish on tip for a perfect fit every time.

Handle: Ergonomic Wiha SoftFinish® multi-component handle with roll-off protection.

Surface resistance 10<sup>6</sup> - 10<sup>9</sup> ohms.

Standards: IEC 61340-5-1.

Application: For working on electrostatically sensitive components.

Order-No.	⊕	↔	●	↔	↔	↔
32156	PZ1	25	4.5	81	34	10
32157	PZ2	25	6.0	81	34	10

# Wiha SoftFinish® ESD.

For use on electrostatically sensitive components.

For TORX® screws.



**362ESD** SoftFinish® ESD TORX® screwdriver.  
Dissipative handle, ESD-safe.

Blade: High quality chrome-vanadium-molybdenum steel, through hardened, chrome-plated.

Wiha ChromTop® finish on tip for a perfect fit every time.

Handle: Ergonomic Wiha SoftFinish® multi-component handle with roll-off protection.

Surface resistance  $10^6 - 10^9$  ohms.

Standards: IEC 61340-5-1.

Application: For working on electrostatically sensitive components.

Order-No.						
31432	T3	60	2.5	164	23	10
27148	T4	60	2.5	164	23	10
27641	T5	60	3.5	164	23	10
27149	T6	60	3.5	164	23	10
31901	T7	60	3.5	164	23	10
22436	T8	60	3.5	164	23	10
27145	T9	60	4.0	171	30	10
27144	T10	80	4.0	191	30	10
27146	T15	80	4.0	191	30	10
27147	T20	100	4.0	218	36	10

Sets.



**302ESD HK5 01** SoftFinish® ESD slotted/ Phillips screwdriver set, 5 pcs.  
Dissipative handle, ESD-safe.

Blade: High quality chrome-vanadium-molybdenum steel, through hardened, chrome-plated.

Wiha ChromTop® finish on tip for a perfect fit every time.

Handle: Ergonomic Wiha SoftFinish® multi-component handle with roll-off protection.

Surface resistance  $10^6 - 10^9$  ohms.

Standards: IEC 61340-5-1.

Application: For working on electrostatically sensitive components.

Order-No.	Series	
27252	302ESD HK5 01	1
	302ESD	3.0x100 4.0x100
	311ESD	PH0x60 PH1x80 PH2x100



**362ESD K5** SoftFinish® ESD TORX® screwdriver set, 5 pcs.  
Dissipative handle, ESD-safe.

Blade: High quality chrome-vanadium-molybdenum steel, through hardened, chrome-plated.

Wiha ChromTop® finish on tip for a perfect fit every time.

Handle: Ergonomic Wiha SoftFinish® multi-component handle with roll-off protection.

Surface resistance  $10^6 - 10^9$  ohms.

Standards: IEC 61340-5-1.

Application: For working on electrostatically sensitive components.

Order-No.	Series	
27253	362ESD K5	1
	362ESD	T6x60 T8x60 T9x60 T10x80 T15x80



**Safety Notice:**

Wiha ESD screwdrivers are noninsulated, therefore not suitable for working on live parts.

# Wiha Precision ESD.

The static dissipative precision screwdriver.



EPA

Wiha ESD precision screwdrivers with the successful handle geometry. Due to the surface resistance of  $10^6 - 10^9$  ohms, defined electrostatic discharge is guaranteed.



The rotating cap with contact area makes incremental adjustment quick and easy.

Electrostatic discharges are a major problem, since even low voltages can damage sensitive components.

Various factors have to be considered in order to understand the problem. In ESD protection areas, the electrostatic charge is safely conducted to earth. Users have to wear the appropriate ESD footwear or grounded wrist strap. The tools used also have to be electrostatically protected.

The ESD screwdrivers from Wiha conform to the international ESD Standards IEC 61340-5-1. Due to the electrical surface resistance,  $10^6 - 10^9$  Ohm, defined electro-



static discharge is guaranteed. Thanks to the rotating cap, incremental adjusting is easy. The large handle enables powerful tightening and loosening of screws.

The dissipative Precision ESD - for working on electrostatically sensitive components.



## Wiha Precision ESD.

- Dissipative handle designed to discharge uniformly, surface resistance  $10^6 - 10^9$  ohms
- Meets ESD standard IEC 61340-5-1
- Rotating cap with large surface for extra fast working
- Large handle end for powerful tightening and loosening screws
- Wiha ChromTop®-finish on tip for a perfect fit every time

# Wiha Precision ESD.

The static dissipative precision screwdriver.

## For slotted, Phillips and Pozidriv screws.



**272** Precision ESD slotted screwdriver.  
Dissipative handle, ESD-safe.

Blade: High quality chrome-vanadium-molybdenum steel, through hardened, chrome-plated.  
Wiha ChromTop® finish on tip for a perfect fit every time.  
Handle: Precision handle with rotating cap, surface resistance  $10^6 - 10^9$  ohms.  
Standards: IEC 61340-5-1.  
Application: For working on electrostatically sensitive components.

Order-No.	①	↔	⊕	●	↔	↔	↔
07634	1.5	40	0.25	2.0	120	12.5	10
07635	2.0	40	0.40	2.0	120	12.5	10
07636	2.5	50	0.40	2.5	145	13.0	10
07637	3.0	50	0.50	3.0	145	13.0	10
07638	3.5	60	0.60	3.5	170	14.0	10
07639	4.0	60	0.80	4.0	170	14.0	10



**273** Precision ESD Phillips screwdriver.  
Dissipative handle, ESD-safe.

Blade: High quality chrome-vanadium-molybdenum steel, through hardened, chrome-plated.  
Wiha ChromTop® finish on tip for a perfect fit every time.  
Handle: Precision handle with rotating cap, surface resistance  $10^6 - 10^9$  ohms.  
Standards: IEC 61340-5-1.  
Application: For working on electrostatically sensitive components.

Order-No.	⊕	↔	●	↔	↔	↔
28053	PH000	40	2.0	120	12.5	10
07640	PH00	40	2.0	120	12.5	10
07641	PH0	50	3.0	145	13.0	10
07642	PH1	60	4.0	170	14.0	10



**274** Precision ESD Pozidriv screwdriver.  
Dissipative handle, ESD-safe.

Blade: High quality chrome-vanadium-molybdenum steel, through hardened, chrome-plated.  
Wiha ChromTop® finish on tip for a perfect fit every time.  
Handle: Precision handle with rotating cap, surface resistance  $10^6 - 10^9$  ohms.  
Standards: IEC 61340-5-1.  
Application: For working on electrostatically sensitive components.

Order-No.	⊕	↔	●	↔	↔	↔
07643	PZ1	60	4.0	170	14	10

## For hex nuts and hex socket screws.



**275** Precision ESD hex screwdriver.  
Dissipative handle, ESD-safe.

Blade: High quality chrome-vanadium-molybdenum steel, through hardened, chrome-plated.  
Wiha ChromTop® finish on tip for a perfect fit every time.  
Handle: Precision handle with rotating cap, surface resistance  $10^6 - 10^9$  ohms.  
Standards: IEC 61340-5-1.  
Application: For working on electrostatically sensitive components.

Order-No.	⊙	↔	↔	↔	↔
27707	0.7	40	120	12.5	10
27708	0.9	40	120	12.5	10
07644	1.3	40	120	12.5	10
07645	1.5	50	145	13.0	10
07646	2	50	145	13.0	10
07647	2.5	60	170	14.0	10
07648	3	60	170	14.0	10
32315	4	60	170	14.0	10



**276** Precision ESD ball end hex screwdriver.  
Dissipative handle, ESD-safe.

Blade: High quality chrome-vanadium-molybdenum steel, through hardened, chrome-plated.  
Wiha ChromTop® finish on tip for a perfect fit every time.  
Handle: Precision handle with rotating cap, surface resistance  $10^6 - 10^9$  ohms.  
Standards: IEC 61340-5-1.  
Application: For working on electrostatically sensitive components.  
Extra: The ball end enables the user to work at angles up to 25°.

Order-No.	⊙	↔	↔	↔	↔
07649	1.5	50	145	13.0	10
07650	2	50	145	13.0	10
07651	2.5	60	170	14.0	10
07652	3	60	170	14.0	10



**277** Precision ESD hex nut driver.  
Dissipative handle, ESD-safe.

Blade: Chrome-vanadium steel, through hardened, chrome-plated.  
Handle: Precision handle with rotating cap, surface resistance  $10^6 - 10^9$  ohms.  
Standards: IEC 61340-5-1.  
Application: For working on electrostatically sensitive components.

Order-No.	⊙	↔	↔	↔	↔	↔
32312	1.5	60	2.5	-	155	13.0
32313	2.0	60	2.9	-	155	13.0
07653	2.5	60	4.0	4.0	155	13.0
07654	3	60	5.0	5.0	155	13.0
07655	3.5	60	5.3	6.0	155	13.0
07656	4	60	5.5	6.0	155	13.0
32314	4.5	60	6.2	7.0	155	13.0
07657	5	60	6.8	7.0	155	13.0
07658	5.5	60	7.6	8.0	170	14.0





**For TORX® screws.**



**278** Precision ESD TORX® screwdriver.  
Dissipative handle, ESD-safe.

Blade: High quality chrome-vanadium-molybdenum steel, through hardened, chrome-plated.  
Wiha ChromTop® finish on tip for a perfect fit every time.  
Handle: Precision handle with rotating cap, surface resistance 10<sup>6</sup> - 10<sup>9</sup> ohms.  
Standards: IEC 61340-5-1.  
Application: For working on electrostatically sensitive components.

Order-No.	⊛	↔	●	↔	↔	↔
25676	T1	40	2.5	120	12.5	10
25677	T2	40	2.5	120	12.5	10
21256	T3	40	2.5	120	12.5	10
21255	T4	40	2.5	120	12.5	10
07659	T5	40	2.5	120	12.5	10
07660	T6	40	2.5	120	12.5	10
07661	T7	40	2.5	120	12.5	10
07662	T8	40	2.5	120	12.5	10
07663	T9	50	3.0	145	13.0	10
07664	T10	50	3.0	145	13.0	10
07665	T15	60	3.5	170	14.0	10
07666	T20	60	4.0	170	14.0	10



**278R** Precision ESD TORX® MagicSpring® screwdriver.  
Dissipative handle, ESD-safe.  
Retaining spring holds TORX® screws in place.

Blade: High quality chrome-vanadium-molybdenum steel, through hardened, chrome-plated.  
Wiha ChromTop® finish on tip for a perfect fit every time.  
Handle: Precision handle with rotating cap, surface resistance 10<sup>6</sup> - 10<sup>9</sup> ohms.  
Standards: IEC 61340-5-1.  
Application: For working on electrostatically sensitive components.

Order-No.	⊛	↔	●	↔	↔	↔
27748	T6	40	2.5	120	12.5	10
27749	T7	40	2.5	120	12.5	10
27759	T8	40	2.5	120	12.5	10
27750	T9	50	3.0	145	13.0	10
27751	T10	50	3.0	145	13.0	10
27752	T15	60	3.5	170	14.0	10

**For TORX PLUS® screws. Chip lifter.**



**278IP** Precision ESD TORX PLUS® screwdriver.  
Dissipative handle, ESD-safe.

Blade: High quality chrome-vanadium-molybdenum steel, through hardened, chrome-plated.  
Wiha ChromTop® finish on tip for a perfect fit every time.  
Handle: Precision handle with rotating cap, surface resistance 10<sup>6</sup> - 10<sup>9</sup> ohms.  
Standards: IEC 61340-5-1.  
Application: For working on electrostatically sensitive components.

Order-No.	⊛	↔	●	↔	↔	↔
28198	4IP	40	2.5	120	12.5	10
27761	5IP	40	2.5	120	12.5	10
27762	6IP	40	2.5	120	12.5	10
27763	7IP	40	2.5	120	12.5	10
27764	8IP	40	2.5	120	12.5	10
27765	9IP	50	3.0	145	13.0	10
27766	10IP	50	3.0	145	13.0	10
27767	15IP	60	3.5	170	14.0	10



**279-10** Precision ESD chip lifter.  
Dissipative handle, ESD-safe.

Blade: High quality chrome-vanadium-molybdenum steel, through hardened, chrome-plated.  
Handle: Precision handle, surface resistance 10<sup>6</sup> - 10<sup>9</sup> ohms.  
Standards: IEC 61340-5-1.  
Application: For lifting tight parts on circuit boards.

Order-No.	↔	↔	↔	↔	↔
07667	3.5	50	145	13.0	10

**Wiha Info**



**Wiha TORX® MagicSpring®.**  
Wiha TORX® MagicSpring®.  
A stainless steel spring securely holds TORX® and TORX PLUS® screws.  
An innovation which convinces any user.

# Wiha Precision ESD.

The static dissipative precision screwdriver.

## ESD screwdriver sets.



**272 K6** Precision ESD slotted/ Phillips screwdriver set, 6 pcs.  
Dissipative handle, ESD-safe.

Blade: High quality chrome-vanadium-molybdenum steel, through hardened, chrome-plated.  
Wiha ChromTop® finish on tip for a perfect fit every time.

Handle: Precision handle with rotating cap, surface resistance  $10^6 - 10^9$  ohms.

Standards: IEC 61340-5-1.

Application: For working on electrostatically sensitive components.

Extra: Practical plastic rack with hanging holes.

Order-No.	Series					
08463	272 K6					1
⓪	272	1.5x40	2.0x40	2.5x50	3.0x50	
⊕	273	PH00x40	PH0x50			

## ESD screwdriver sets.



**277 K6** Precision ESD hex nut driver set, 6 pcs.  
Dissipative handle, ESD-safe.

Blade: Chrome-vanadium steel, through hardened, chrome-plated.

Handle: Precision handle with rotating cap, surface resistance  $10^6 - 10^9$  ohms.

Standards: IEC 61340-5-1.

Application: For working on electrostatically sensitive components.

Extra: Practical plastic rack with hanging holes.

Order-No.	Series				
32279	277 K6				1
⓪	277	2.5x60	3x60	3.5x60	
		4x60	5x60	5.5x60	



**275 K6** Precision ESD hex screwdriver set, 6 pcs.  
Dissipative handle, ESD-safe.

Blade: High quality chrome-vanadium-molybdenum steel, through hardened, chrome-plated.  
Wiha ChromTop® finish on tip for a perfect fit every time.

Handle: Precision handle with rotating cap, surface resistance  $10^6 - 10^9$  ohms.

Standards: IEC 61340-5-1.

Application: For working on electrostatically sensitive components.

Extra: Practical plastic rack with hanging holes.

Order-No.	Series					
32278	275 K6					1
⓪	275	0.9x40	1.3x40	1.5x50		
		2x50	2.5x60	3x60		



**278 K6** Precision ESD TORX® screwdriver set, 6 pcs.  
Dissipative handle, ESD-safe.

Blade: High quality chrome-vanadium-molybdenum steel, through hardened, chrome-plated.  
Wiha ChromTop® finish on tip for a perfect fit every time.

Handle: Precision handle with rotating cap, surface resistance  $10^6 - 10^9$  ohms.

Standards: IEC 61340-5-1.

Application: For working on electrostatically sensitive components.

Extra: Practical plastic rack with hanging holes.

Order-No.	Series				
26919	278 K6				1
⓪	278	T5x40	T6x40	T7x40	
		T8x40	T10x50	T15x60	



# Wiha Ceramic.

The non-static adjustment tool for clean rooms.



The Wiha Ceramic precision screwdrivers with blades made of high-tech zirconium ceramic are the perfect tools for all applications in clean rooms and for delicate electrostatic components. In these areas there are high requirements in terms of eddy-current losses.

The ceramic blades and handles are completely antimagnetic and anti-static. This is a fundamental requirement for working with highly sensitive components, such as capacitors, solenoids and various

resistances. The ceramic blades are resistant to mechanical wear, acid corrosion and thermal shock stress. Wiha Ceramic screwdrivers are available with slotted and Phillips tips, as well as in a set.

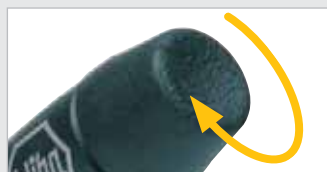

With centring head and quick-turning zone for optimum handling.



The ceramic blade and handle are completely anti-magnetic and anti-static.



## Wiha Ceramic.

- Ideal for adjusting electrical components
- Suitable for working in clean rooms
- Anti-static and anti-magnetic handle and blade
- Rotating cap for easy working
- Resistant to mechanical wear, thermal shock stress and acidic corrosion

### For slotted and Phillips screws.



**270** Ceramic slotted screwdriver.  
Non-static adjustment tool with ceramic blade.

Blade: Made of high-quality special ceramic, anti-static/ anti-magnetic.  
Handle: Wiha Proturm® Precision handle with rotating cap, anti-static/anti-magnetic.  
Application: Specially designed for tuning and adjusting high frequency devices, suited to cleanrooms.

Order-No.	⌀	→	⊖	●	←	+	⊞
02163	0.9	15	0.35	1.75	94.5	12.5	10
02164	1.3	15	0.35	1.75	94.5	12.5	10
02167	1.8	15	0.35	1.75	94.5	12.5	10
02168	2.6	15	0.35	2.6	94.5	12.5	10



**271** Ceramic Phillips screwdriver.  
Non-static adjustment tool with ceramic blade.

Order-No.	⊕	→	●	←	+	⊞
02169	PH0	15	2.6	94.5	12.5	10

### Ceramic screwdriver set.



**270 HK3** Ceramic slotted/ Phillips screwdriver set, 3 pcs.  
Non-static adjustment tool with ceramic blade.











Blade: Delivered in practical plastic box.

Order-No.	Series	⊞
02171	270 HK3	1
⊖	270	0.9x15 2.6x15
⊕	271	PH0x15

# Wiha torque screwdrivers.

Wiha makes it possible: Optimal handling for perfect work.



	 Schlitz SL	 Phillips PH	 Xeno SL/PH	 Pozidriv PZ	 Xeno SL/PZ	 TORX*	 TORX PLUS*	 For internal hex screws	 For hex nuts	 For internal square screws	
Torque screwdrivers	90	88/90		88/90		88/91	88/91	88/90			
Torque VDE screwdrivers	94 96-97	94-97	94	94-97	93/94 96/97	94/96		94/95		95	
Torque ESD screwdrivers	99	99		99		99					
Torque T-handle						103-104 107	103/107	103/107			
Torque VDE T-handle						105		105	105		



## Torque screwdriver assortment

### Wiha torque screwdrivers.

Exact and with high repeat precision.....	82 – 83
Diverse areas of application in trade and industry.....	84
Overview of Wiha torque tools.....	85

### Wiha torque screwdrivers.

For every application the correct model.



Wiha iTorque.....	86 – 87
-------------------	---------



Wiha TorqueVario®-S.....	88
--------------------------	----



Wiha TorqueFix®.....	89
----------------------	----



Wiha easyTorque.....	89
----------------------	----

Wiha Torque Wechselklingen.....	90 – 91
---------------------------------	---------

### Wiha VDE torque range.



Wiha TorqueVario®-S VDE.....	92 – 97	NEW
------------------------------	---------	-----



Wiha TorqueVario®-S TR VDE.....	105
---------------------------------	-----

### Wiha ESD torque range.



TorqueVario®-S ESD.....	98 – 99
-------------------------	---------

### Wiha Torque TR.



Wiha TorqueVario®-S TR.....	100 – 104	NEW
-----------------------------	-----------	-----

Wiha TorqueFix® TR.....	102 – 104
-------------------------	-----------

Wiha easyTorque TR.....	102 – 104
-------------------------	-----------

Wiha TorqueVario®-S-TR VDE.....	105
---------------------------------	-----

### Wiha T-handle torque tools.

For screw applications requiring a specific amount of force.



Wiha TorqueVario®-STplus	103 – 104
Wiha TorqueFix-Tplus.....	



Wiha TorqueFix®-Key.....	106 – 107
--------------------------	-----------

# Wiha torque screwdrivers.

Exact and with high repeat precision.



A convincing concept.  
The exact torque!

This is more and more vital for accurate and efficient work, especially when such accuracy must be maintained and repeated, as with fastening and unfastening sensitive and expensive components, in assembly or in final inspections

and quality assurance applications. These are all perfect tasks for the new Wiha torque tools with their ergonomic handles, a unique interchangeable blade system and practical problem solutions.

## Torque specialist

- Long-term application experience
- Comprehensive range
- Innovation down to the smallest detail
- Single unit adjustment based on customer specifications

## Wiha Services – Calibration and Co.

- Wide spectrum of recalibration services
- Quick, competent processing
- Repeat precision and reliability

## A wide spectrum of products / services

- Industry, ESD and VDE applications

## Highest quality standards and latest production technology

- Individual unit testing with calibration certificate
- Individual unit designation with identification number

## Perceptible ergonomics

- Award-winning Wiha handle size concept
- Comfortable multi-component handles

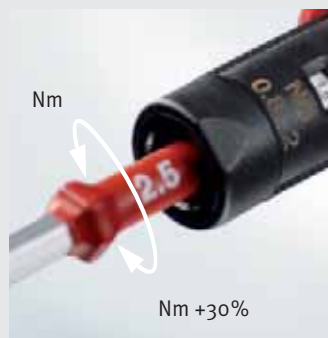



## Wiha torque screwdrivers.

### Quality is the guiding principle

- Use of innovative materials for maximum service life
- Complies with all common standards
- Torque accuracy  $\pm 6\%$  of the pre-set scale value
- Maximum precision with special calibration and labelling systems

### Innovation down to the smallest detail

- Simple, intuitive operation
- Distinctly audible and perceptible click signal
- Numerical, stepless display of torque values enable rapid identification without reading errors
- Limited loosening and tightening torque

### The right tool for every application

- Wide product assortment: Industry, ESD and VDE
- User-oriented development of problem solutions
- Flexible exchange blade system with colour coding



iTorque



TorqueVario®-S



TorqueVario®-S VDE



TorqueVario®-S ESD



TorqueFix®



easyTorque

**NEW**



TorqueVario®-S TR  
TorqueVario®-S TR VDE  
TorqueFix® TR  
easyTorque TR



TorqueVario®-STplus  
TorqueFix®-Tplus

**NEW**



TorqueFix®-Key

# Wiha torque screwdrivers.

Diverse areas of application in trade and industry.

New materials – sensitive electronic components in extremely tight spaces – automated processes in production technology – just a few of many examples that illustrate how rapidly industrial and trade applications are developing. The demands for correct fastening of

components also grow with these changes. Only in this way for example is it possible to eliminate protection from humidity or the danger of damage to materials in production processes.

## Industrial applications:



### Industrial installations

Using torque tools is vital to assure a uniformly high quality in manufacturing.



### Fastening of indexable cutter inserts

In the metal cutting industry, great importance is attached to process safety. When changing indexable cutter inserts, this can only be ensured by using torque tools.



### Sensitive fastenings in the ESD protected zone

Printed circuit boards and electronic semiconductor components react extremely sensitively to mechanical loads. The correct torque guarantees secure installation of cost-intensive materials.



### Circular plug connector - protection class IP67

For correct functioning of distributions systems on machines, the correct torque must be observed when connecting the circular plug connectors. Otherwise the protection class IP67 cannot be complied

### Smartphones and Co.

Today's electronic devices are always smaller and more efficient. This makes smaller screws necessary which are fastened in sensitive materials such as plastic. Without the correct torque, these screws are damaged or the plastic

## Trade applications



### Type-tested switching devices

For type-tested switching devices, the torque to be observed is specified by all manufacturers to prevent the formation of glowing contact areas.



### Installation of glass elements

Particularly for materials such as glass which react sensitively to pressure and tension, fastening with the recommended torque is a prerequisite.



### Electrical devices in outdoor areas

This type of device must be protected from penetrating humidity and are e.g. subject to the protection class IP67. In order to ensure this, all housing screws must be tightened with the torque according to man



### Solar technology

Overtightened screws can damage the sensitive photovoltaic modules. In contrast, secure fastening cannot be guaranteed with screws which are not tightened enough.













### Composite materials

The use of new materials such as carbon make using torque tools vital. The carbon structure is damaged by the incorrect torque during fastening. Because of this, the material no longer withstands the requirements.



# Wiha torque screwdrivers.

## Overview of torque tools

	Precision	Setting	Special feature	Nm range	Torque range				Suitable blade range
					0,01 Nm	0,1 Nm	1 Nm	10 Nm	
<b>Mechatronic torque screwdriver</b>									
 <b>iTorque</b> 2835	±6%	Adjustable	Digital display Click control Calibration alert Can be recalibrated	0,4 - 1,5 0,8 - 3,0 1,0 - 6,0					Serie 2859
<b>Mechanical torque screwdriver</b>									
 <b>TorqueVario®-S</b> 2852	±10% (0,1 - 0,46 Nm)	Adjustable	Numeric scale	0,04 - 0,46					Serie 2859
	±6% / ±10%			0,1 - 0,6					
	±6%			0,4 - 1,0					
				0,8 - 2,0					
				1,0 - 5,0					
 <b>TorqueVario®-S VDE</b> 2872	±6%	Adjustable	VDE certification Numeric scale	0,6 - 2,0				slimBits Serie 2831	
				1,0 - 5,0					
				2,0 - 8,0					
 <b>TorqueVario®-S ESD</b> 2882	±10% (0,1 - 0,46 Nm)	Adjustable	ESD safe Numeric scale	0,04 - 0,46				Serie 2889	
	±6% / ±10%			0,1 - 0,6					
	±6%			0,4 - 1,0					
				0,8 - 2,0					
 <b>TorqueFix®</b> 2850	±6%	Fixed	Pre-set at factory	16 Versionen 0,4 - 7,2				Serie 2859	
 <b>easyTorque</b> 292	±10%			13 Versionen 0,5 - 5,0				Serie 2859	
<b>Mechanical Torque T-handle</b>									
 <b>TorqueVario®-S TR</b> 2833	±6%	Adjustable	Numeric scale	2 - 8				Serie 2899	
 <b>TorqueFix TR</b> 2833	±6%	Adjustable	Pre-set at factory	2 Versionen 6,0 - 8,0				Serie 2899	
 <b>easyTorque TR</b> 2834	±10%	Fixed	Pre-set at factory	2 Versionen 6,0 - 8,0				Serie 2899	
 <b>TorqueVario®-S TR VDE</b> 2837	±6%	Adjustable	VDE certification Numeric scale	2 - 8				Serie 28379	
 <b>TorqueVario®-STplus</b> 2893	±6%	Adjustable	Numeric scale	5,0 - 14				Serie 2899	
 <b>TorqueFix®-Tplus</b> 2891	±6%	Fixed	Pre-set at factory	6 Versionen 6,0 - 14				Serie 2899	
 <b>TorqueFix Key</b> 2836	±6%	Fixed	Pre-set at factory	0,5 - 4,0				Serie 28369	

# Wiha iTorque.

The intelligent torque tool.



product  
design award

2013



reddot design award  
winner 2013



Focus Open  
Silver 2012



## "i" as in "intelligent" - the iTorque

Mechatronic version, highly precise and convenient to use - the intelligent iTorque screwdriver sets new standards in the torque world.

### Technology down to the smallest detail

iTorque, superior design from A to Z. Operation could not be simpler or more efficient: the required value on the display is rapidly set with the setting wheel at the handle end, completely without tools.

The digital display impresses with a clear display: no more reading errors, but simple, individual setting options. Especially practical: A short click and all units are switched over according to needs (Nm 1 in.lb)

The plastic metal compound handle also convinces: with perceptible ergonomics, high quality robust materials and optimal distribution of soft zones. And of course handle sizes optimally matched to specific torque ranges.

### Modern, efficient testing equipment monitoring: All applications count!

iTorque also sets new quality assurance standards. Its integrated counter records all applications and shows their actual number. An integrated alert function promptly reminds the user of the pre-specified calibration cycle that can be individually set with ordering.

And for practical purposes that means: the calibration interval can be optimally matched to the number of applications according to user and application.

Further practical details round off the profile of the all-rounder: with the test equipment marking that cannot be lost and that can be freely specified, each iTorque becomes a unique object. And thanks to the interchangeable blade system the blades of all Wiha torque screwdrivers can be randomly changed.

All in all: innovative mechatronics paired with sophisticated operating comfort.

### The new iTorque.



## Wiha iTorque.

- Mechatronic technology
- Nm-setting shown on digital display
- Click control
- Display indicates when calibration is necessary
- Release accuracy  $\pm 6\%$

## iTorque with scale.



2835

**iTorque mechatronic torque screwdriver.**  
Torque value can be set via a digital scale.  
Automatic release with calibration alert.

- Handle:** Torque can be conveniently set directly via push button integrated in handle.  
Ergonomic plastic/metal compound handle of quality, robust materials. Handle sizes proportioned to optimise torque setting. Distinctly audible and perceptible click signal when set torque is reached. Compatible with all blades of the 2859 series.
- Standards:** EN ISO 6798, BS EN 26789, ASME B107.14M.
- Accuracy:**  $\pm 6\%$ , traceable to national standards.
- Bit holder:** Torque bit universal holder exchange blade for accommodating C 6.3 and E 6.3 (1/4") bits (included in delivery).
- Application:** For applications where recommended torque settings are important. Use in combination with a Wiha torque interchangeable blade.
- Extra:** Click Control - integrated counter records all applications. Calibration alert following 5,000 applications (normative reference value/resettable). Large digital display for simple stepless setting of torque value. Units can be simply switched - Nm in.lbs / Ncm in.oz. Can be individualised in the order process – information available at [mytorque.wiha.com](http://mytorque.wiha.com).
- Individual:** Products can be designed individually using the configurator at [mytorque.wiha.com](http://mytorque.wiha.com). (Can be chosen freely: two text fields, graphics field, calibration alarm, torque unit)

Order-No.	Nm		±6%	Ø	↔	+	↔
36886	40-150 Ncm	60-210 in.oz	6%	4	134	34	1
36887	0.8-3.0	7-26 in.lbs	6%	4	134	34	1
36888	1.0-6.0	9-50 in.lbs	6%	4	134	40	1



Can be set without separate tool



Large digital display with numeric display prevents reading errors

Units can be switched  
(Nm in.lb/ Ncm in.oz)

Torque accuracy  $\pm 6\%$  of the pre-set scale value



ClickControl counting function records every single use and optimises testing equipment monitoring



Calibration alert after 5,000 uses for absolute process safety with testing equipment monitoring. Calibration alert cycles can be individually adjusted when ordering the product.



### Individualisation

Individual permanent lasering of customer information (e.g. testing equipment number, workplace designation, company logo)



### Wiha Services

Can be recalibrated by Wiha Services

# Wiha torque screwdrivers.

## TorqueVario®-S with scale.



### 2852 TorqueVario®-S Torque screwdriver.

Torque value can be set via window scale.  
Automatic release.

- Handle: Torque infinitely adjustable with Torque-Setter setting tool (also supplied).  
Ergonomic multi-component handle, particularly light and compact. Handle sizes proportioned to optimise torque setting.  
Audible and perceptible click when the pre-set torque has been attained.  
Compatible with all blades of the 2859 series.
- Standards: EN ISO 6798, BS EN 26789, ASME B107.14M.
- Accuracy: ±6%, tracing to national standards (see table for other tolerances).
- Application: For applications where recommended torque settings are important. Use in combination with a Wiha torque interchangeable blade.
- Extra: Delivered in practical plastic box.  
Incl. works inspection protocol.
- Note: Bit holders or blades are not included in delivery.
- Individual: Products can be designed individually using the configurator at [mytorque.wiha.com](http://mytorque.wiha.com).  
(Can be chosen freely: text field, torque unit)

Order-No.	Nm	EA%	○	→	↓	☑
36849	0.04-0.46•	10%	4	127	23	1
26888	0.1-0.6	10%	4	127	23	1
36850	0.1-0.6	6%	4	127	23	1
26461	0.4-1.0	6%	4	127	23	1
26462	0.8-2.0	6%	4	131	30	1
26463	1.0-5.0	6%	4	138	36	1
26464	2.0-8.0	6%	4	142	41	1

• Precision in range of 0.1-0.46 Nm



### 285-900 Torque-Setter.

Setting tool for variable torque screwdrivers.  
Included in every torque screwdriver delivery.

- Blade: Octagonal blade, through hardened, zinc-plated.
- Supplement: Included in every torque screwdriver delivery.

Order-No.	→	↓	☑
26864	150	80	1

## TorqueVario®-S sets.



### 2852 S10 TorqueVario®-S Torque screwdriver set, 13 pcs.

- Torque value can be set via window scale.  
With bit universal holder and 10 Phillips/ Pozidriv/ TORX®/ hex Standard bits.
- Handle: Model 1.0-5.0 Nm.  
Torque infinitely adjustable with Torque-Setter setting tool (also supplied).  
Ergonomic multi-component handle, particularly light and compact.  
Audible and perceptible click when the pre-set torque has been attained.
- Standards: EN ISO 6798, BS EN 26789, ASME B107.14M.
- Accuracy: ±6%, traceable to national standards.
- Application: For applications where recommended torque settings are important.  
Supply in robust box.
- Extra: Incl. works inspection protocol.

Order-No.	Series	☑
26893	2852 S10	1
	2852	TorqueVario®-S, model 1.0-5.0 Nm
	2859	Torque bit universal holder
	285-900	Torque-Setter
+	7011 Z	PH1x25 PH2x25
+	7012 Z	PZ1x25 PZ2x25
+	7015 Z	T10x25 T15x25 T20x25 T25x25
●	7013 Z	3.0x25 4.0x25



### 2852 S10-01 TorqueVario®-S Torque screwdriver set, 13 pcs.

- Torque value can be set via window scale.  
With bit universal holder and 10 TORX®/ TORX PLUS® Standard bits especially for applications with indexable cutter inserts.

Order-No.	Series	☑
34614	2852 S10-01	1
	2852	TorqueVario®-S, model 1.0-5.0 Nm
	2859	Torque bit universal holder
	285-900	Torque-Setter
+	7015 Z	T7x25 T8x25 T9x25 T10x25 T15x25
+	7016 Z	7IPx25 8IPx25 9IPx25 10IPx25 15IPx25



## TorqueFix® and Torque cable key.

**2850** TorqueFix® torque screwdriver.  
 With a fixed torque value pre-set by Wiha.  
 Automatic release.

- Handle:** Ergonomic multi-component handle, particularly light and compact. Handle sizes proportioned to optimise torque setting. Audible and perceptible click when the pre-set torque has been attained.
- Standards:** EN ISO 6798, BS EN 26789, ASME B107.14M.
- Accuracy:** ±6%, traceable to national standards.
- Application:** For applications where recommended torque settings are important. Use in combination with a Wiha torque interchangeable blade.
- Extra:** Delivered in practical plastic box, incl. factory calibration certificate.
- Note:** The below articles are available from stock. Further articles with pre-set, customer torque values of between 0.15 and 8 Nm are available on request. Bit holders or blades are not included in delivery.
- Individual:** Products can be designed individually using the configurator at [mytorque.wiha.com](http://mytorque.wiha.com). (Can be chosen freely: text field, torque unit, torque value)

Order-No.	Nm	±%	⊙	↔	⚙	📦
26925	0.4	6%	4	112	23	1
26127	0.5	6%	4	112	23	1
26047	0.6	6%	4	112	23	1
26327	0.8	6%	4	112	23	1
26048	0.9	6%	4	112	23	1
26133	1.1	6%	4	119	30	1
26049	1.2	6%	4	119	30	1
26901	1.5	6%	4	119	30	1
26051	2.0	6%	4	119	30	1
26128	2.5	6%	4	119	30	1
26052	3.0	6%	4	126	36	1
26129	3.8	6%	4	126	36	1
26053	5.0	6%	4	132	41	1
26130	5.5	6%	4	132	41	1
34533	6.0	6%	4	132	41	1
26131	7.2	6%	4	132	41	1

**2850 S2** Torque cable key set for circular plug connectors.  
 For Wiha torque screwdrivers.

- Handle:** TorqueFix® torque screwdrivers. Ergonomic multi-component handle, particularly light and compact.
- Material:** Robust, glass-fibre reinforced plastic combines the high quality hexagonal stainless steel insert with the blade tang of chrome-vanadium-molybdenum steel.
- Application:** For controlled fastening of circular plug connectors with hexagonal head according to specified torque.

Order-No.	Nm	⊙	mm	↔	⚙	⚙	📦
36846	0.4	9	230	78	112	23	1
36847	0.6	13	230	78	112	23	1
36848	1.5	22	240	90	119	30	1

## easyTorque.

**292** easyTorque torque screwdriver.  
 With a fixed torque value ex-factory.

- Handle:** Multi-component handle optimally designed for the hand enables optimal power transmission. Audible and perceptible click when the pre-set torque has been attained. Rapid identification with imprint on handle end. Unlimited loosening torque. Mechanism insensitive to industrial lubricants. Compatible with all blades of the 2859 series.
- Accuracy:** ±10%
- Application:** For applications where recommended torque settings are important. Use in combination with a Wiha torque interchangeable blade.
- Note:** Bit holders or blades are not included in delivery.

Order-No.	Nm	±%	⊙	↔	⚙	📦
36229	0.5	10%	4	130	34	1
36230	0.6	10%	4	130	34	1
36240	0.9	10%	4	130	34	1
36231	1.1	10%	4	130	34	1
36233	1.2	10%	4	130	34	1
36234	1.4	10%	4	130	34	1
36235	2.0	10%	4	130	34	1
36236	2.5	10%	4	130	34	1
36237	3.0	10%	4	130	34	1
36238	3.8	10%	4	130	34	1
36320	4.0	10%	4	130	34	1
36321	4.5	10%	4	130	34	1
36239	5.0	10%	4	130	34	1

# Wiha torque screwdrivers.

## Torque interchangeable blades.



### 2859 Torque slotted interchangeable blade. For Wiha torque screwdrivers.

Blade: High quality chrome-vanadium-molybdenum steel, through hardened, chrome-plated.  
Wiha ChromTop® finish on tip for a perfect fit every time.  
Colour-coding: grey.

Standards: Blade tip DIN ISO 2380-1.

Application: For applications where recommended torque settings are important.

Order-No.	⊖	⊕	⬠	↔	↔	max. Nm	⊞
26227	0.25	1.5	4	175	42	0.15	10
26228	0.4	2.0	4	175	42	0.4	10
26151	0.4	2.5	4	175	42	0.4	10
26277	0.5	3.0	4	175	42	0.6	10
26278	0.6	3.5	4	175	42	1.1	10
26279	0.8	4.0	4	175	42	2.5	10



### 2859 Torque Phillips interchangeable blade. For Wiha torque screwdrivers.

Blade: High quality chrome-vanadium-molybdenum steel, through hardened, chrome-plated.  
Wiha ChromTop® finish on tip for a perfect fit every time.  
Colour-coding: dark blue.

Standards: Blade tip DIN ISO 8764-1.

Application: For applications where recommended torque settings are important.

Order-No.	⊕	⬠	↔	↔	max. Nm	⊞
26199	PH000	4	175	42	0.4	10
26196	PH00	4	175	42	0.4	10
26197	PH0	4	175	42	0.9	10
26058	PH1	4	175	42	3.8	10
27079	PH2	4	175	42	5.5	10



### 2859 Torque cable key for circular plug connectors. For Wiha torque screwdrivers.

Material: Robust, glass-fibre reinforced plastic combines the high quality hexagonal stainless steel insert with the blade tang of chrome-vanadium-molybdenum steel.

Application: For controlled fastening of circular plug connectors with hexagonal head according to specified torque.

Order-No.	⊖	⬠	↔	↔	max. Nm	⊞
36414	8	4	78	218	1	10
36415	9	4	78	218	1	10
38004	11	4	78	218	1.5	NEW 10
36413	1/2"	4	78	218	1.5	10
36416	12	4	78	218	1.5	10
36417	13	4	78	218	1.5	10
36418	14	4	78	218	1.5	10
36419	17	4	78	218	1.5	10
36421	18	4	78	218	1.5	5
36553	19	4	78	218	1.5	5
36422	22	4	90	233	2	5
36423	24	4	90	233	2	5

## Torque interchangeable blades.



### 2859 Torque Pozidriv interchangeable blade. For Wiha torque screwdrivers.

Blade: High quality chrome-vanadium-molybdenum steel, through hardened, chrome-plated.  
Wiha ChromTop® finish on tip for a perfect fit every time.  
Colour-coding: light blue.

Standards: Blade tip DIN ISO 8764-1.

Application: For applications where recommended torque settings are important.

Order-No.	⊕	⬠	↔	↔	max. Nm	⊞
26198	PZ0	4	175	42	0.9	10
26148	PZ1	4	175	42	3.8	10
26889	PZ2	4	175	42	5.5	10



### 2859 Torque hex interchangeable blade. For Wiha torque screwdrivers.

Blade: High quality chrome-vanadium-molybdenum steel, through hardened, chrome-plated.  
Wiha ChromTop® finish on tip for a perfect fit every time.  
Colour-coding: red.

Application: For applications where recommended torque settings are important.

Order-No.	⬠	⬠	↔	↔	max. Nm	⊞
26544	1.3	4	175	42	0.4	10
26200	1.5	4	175	42	0.9	10
26060	2.0	4	175	42	1.8	10
26061	2.5	4	175	42	3.8	10
26062	3.0	4	175	42	5.5	10
26063	4.0	4	175	42	8.0	10



### 2859 Torque ball end hex interchangeable blade. For Wiha torque screwdrivers.

Blade: High quality chrome-vanadium-molybdenum steel, through hardened, chrome-plated.  
Wiha ChromTop® finish on tip for a perfect fit every time.  
Colour-coding: red.

Application: For applications where recommended torque settings are important.  
Extra: The ball end enables the user to work at angles up to 25°.

Order-No.	⬠	⬠	↔	↔	max. Nm	⊞
26221	1.5	4	175	42	0.4	10
26222	2.0	4	175	42	0.9	10
26223	2.5	4	175	42	2.0	10
26224	3.0	4	175	42	3.8	10
26225	4.0	4	175	42	8.0	10

**Torque interchangeable blades.**



**2859** Torque TORX® interchangeable blade.  
For Wiha torque screwdrivers.

Blade: High quality chrome-vanadium-molybdenum steel, through hardened, chrome-plated.  
Wiha ChromTop® finish on tip for a perfect fit every time.  
Colour-coding: dark green.

Application: For applications where recommended torque settings are important.  
Extra: Very slim blade diameter for hard-to-reach screws.

Order-No.	●	●	↔	↔	max. Nm	↔
30852	T4	4	175	42	0.25	10
26158	T5	4	175	42	0.4	10
26064	T6	4	175	42	0.6	10
26065	T7	4	175	42	0.9	10
26066	T8	4	175	42	1.3	10
26059	T9	4	175	42	2.5	10
26067	T10	4	175	42	3.7	10
26068	T15	4	175	42	5.5	10
26069	T20	4	175	42	8.0	10
26070	T25	4	175	42	8.0	10

**Torque interchangeable blades.**



**2859** Torque TORX PLUS® interchangeable blade.  
For Wiha torque screwdrivers.

Blade: High quality chrome-vanadium-molybdenum steel, through hardened, chrome-plated.  
Wiha ChromTop® finish on tip for a perfect fit every time.  
Colour-coding: light green.

Application: For applications where recommended torque settings are important.  
Extra: Very slim blade diameter for hard-to-reach screws.

Order-No.	●	●	↔	↔	max. Nm	↔
26159	5IP	4	175	42	0.5	10
26071	6IP	4	175	42	0.8	10
26152	7IP	4	175	42	1.3	10
26072	8IP	4	175	42	2.0	10
26154	9IP	4	175	42	3.0	10
26155	10IP	4	175	42	4.5	10
26073	15IP	4	175	42	6.6	10
26156	20IP	4	175	42	8.0	10
26157	25IP	4	175	42	8.0	10



**2859** Torque TORX® MagicSpring® interchangeable blade.  
For Wiha torque screwdrivers.  
Retaining spring holds TORX® screws in place.

Blade: High quality chrome-vanadium-molybdenum steel, through hardened, chrome-plated.  
Wiha ChromTop® finish on tip for a perfect fit every time.  
Colour-coding: dark green.

Application: For applications where recommended torque settings are important.  
Extra: Very slim blade diameter for hard-to-reach screws.

Order-No.	●	●	↔	↔	max. Nm	↔
27818	T6	4	175	42	0.6	10
27812	T7	4	175	42	0.9	10
27813	T8	4	175	42	1.3	10
27814	T9	4	175	42	2.5	10
27815	T10	4	175	42	3.8	10
27816	T15	4	175	42	5.5	10
27817	T20	4	175	42	8.0	10
29467	T25	4	175	42	8.0	10



**2859** Torque TORX PLUS® MagicSpring® interchangeable blade.  
For Wiha torque screwdrivers.  
Retaining spring holds TORX PLUS® screws in place.

Blade: High quality chrome-vanadium-molybdenum steel, through hardened, chrome-plated.  
Wiha ChromTop® finish on tip for a perfect fit every time.  
Colour-coding: light green.

Application: For applications where recommended torque settings are important.  
Extra: Very slim blade diameter for hard-to-reach screws.

Order-No.	●	●	↔	↔	max. Nm	↔
29553	6IP	4	175	42	0.8	10
29554	7IP	4	175	42	1.3	10
29555	8IP	4	175	42	2.0	10
29556	9IP	4	175	42	3.0	10
29557	10IP	4	175	42	4.5	10
29558	15IP	4	175	42	6.6	10
29559	20IP	4	175	42	8.0	10
29560	25IP	4	175	42	8.0	10



**2859** Torque bit universal holder.  
For Wiha torque screwdrivers.  
Suitable for C 6.3 and E 6.3 (1/4") bits.

Blade: High quality chrome-vanadium-molybdenum steel, through hardened, chrome-plated.  
Sleeve: Made of stainless steel, black-plastic coated.  
Application: For applications where recommended torque settings are important.

Order-No.	○	●	↔	↔	↔
27526	1/4	4	162	11	10



**2859** Torque adapter blade.  
For Wiha torque screwdrivers.  
Suitable for 1/4" square sockets.

Blade: High quality chrome-vanadium-molybdenum steel, through hardened, chrome-plated.  
Head: Nickel-plated, spring-mounted ball.  
Application: For applications where recommended torque settings are important.

Order-No.	●	●	↔	↔	↔
26229	1/4	4	155		10

# Wiha Torque VDE screwdrivers.

Precise with repeat accuracy.



product design award  
2011



Focus Open Silver 2011

slimTECHNOLOGY

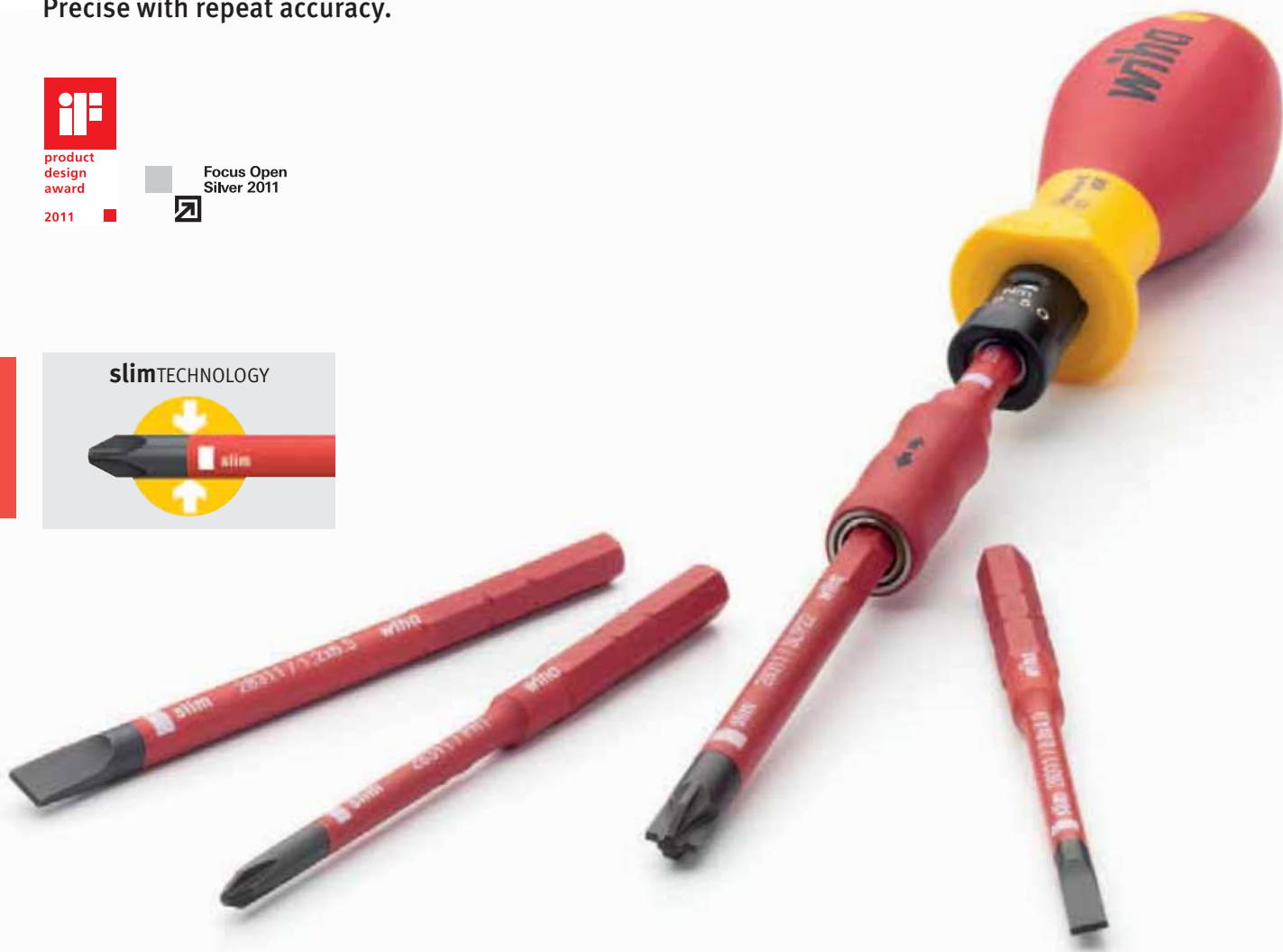

TorqueVario®-S VDE. Completely certified VDE torque system.

The TorqueVario®-S VDE with integrated scale in combination with the slimTorque VDE bit holder and slimBits offer controlled tightening of screws with simultaneous user safety fo



**slimTECHNOLOGY:**  
Up to 33% narrower bits ensures unimpeded access to low-lying fastenings/ spring elements in the critical working area.



In type-tested switchgear systems, the torque to be observed is specified by all manufacturers.



**Wiha Torque VDE screwdrivers.**

- Clearly audible and perceptible click on attaining the pre-set torque
- Torque accuracy  $\pm 6\%$  of the pre-set scale value
- Delivered with factory calibration certificate
- Safety when working with live equipment up to 1,000 V AC and 1,500 V DC
- Fulfills all accuracy requirements as defined by EN ISO 6789, BS EN 26789 and ASME B 107.14M



**Wiha slimTorque VDE bit holder.**

- Absolute safety even if mistakes are made: no metal connection between the bit holder and blade tang





**Safety Notice:**

When working with VDE tools, observe the national safety and accident prevention regulations!



**TorqueVario®-S VDE. slimTorque VDE bit holder.**

with scale



1000 V IEC 60900:2012

**2872** TorqueVario®-S VDE torque screwdriver.  
 Insulation up to 1,000 V AC, GS-mark.  
**Torque value can be set via window scale. Automatic release.**

Handle: Torque infinitely adjustable with Torque-Setter setting tool (also supplied).  
 Ergonomic multi-component handle, insulation up to 1,000 V AC, GS mark.  
 Handle sizes proportioned to optimise torque setting.  
 Audible and perceptible click when the pre-set torque has been attained.  
 Compatible with all blades of the 2831 series in connection with the bit holder (2879 series).

Standards: Manufactured acc. to IEC 60900:2012.  
 EN ISO 6798, BS EN 26789, ASME B107.14M.

Accuracy: ±6%, traceable to national standards.

Bit holder: slimTorque VDE bit holder (included in delivery) for 6 mm slimBits.

Application: For controlled fastening on live parts up to 1,000 V AC, for use only in combination with a slimTorque VDE bit holder for 6 mm slimBits.

Extra: Delivered in practical plastic box, incl. factory calibration certificate.

Individual: Products can be designed individually using the configurator at mytorque.wiha.com. (Can be chosen freely: text field, torque unit)

Order-No.	Nm	±%	Ø	mm	mm	mm
26625	0.6-2.0	6%	3.8	131	30	1
26626	1.0-5.0	6%	3.8	138	36	1
26627	2.0-8.0	6%	3.8	142	41	1



1000 V IEC 60900:2012

**2879** slimTorque VDE bit holder for 6 mm slimBits.  
 Insulation up to 1,000 V AC, GS-mark.  
**Exclusively for Wiha VDE torque screwdrivers.**

Blade: High quality chrome-vanadium-molybdenum steel, through hardened, black-finish.  
 Insulation moulded directly onto blade.

Standards: Manufactured acc. to IEC 60900:2012.

Bit holder: Insulated metal ClicFix bit holder locks all slimBits reliability.  
 Only for 6 mm slimBits.

Application: For use of Wiha 6 mm slimBits with Wiha VDE torque screwdrivers.

Attention: Not for use with bit styles C 6.3 and E 6.3.

Order-No.	Ø	mm	mm	mm	mm
35870	6	3.8	170	13	5

**slimTorque starter set. Torque setter.**

with scale



1000 V IEC 60900:2012

**NEW**  
**2872 S3** slimTorque starter set, 5-pcs.  
**Torque value can be set via window scale.**  
**With slimTorque VDE bit holder for 6 mm slimBits.**

Handle: VDE torque handle 1.0 - 5.0 Nm, steplessly adjustable with Torque Setter adjusting tool (included in delivery).

Bit holder: Insulated metal ClicFix bit holder locks all slimBits reliability.  
 Only for 6 mm slimBits.

Bits: Protective insulation moulded directly onto the bit and completely integrated into the bit in the lower area.  
 Individually tested protective insulation 1,000 V AC, VDE and GS tested.

Application: For controlled fastening on live parts up to 1 000 V AC.

Extra: 100% safety from fastening with torque according to specification of manufacturer type-tested switching devices according to EN 60439-1.

Order-No.	Series	mm
38074	2872 S3	1
	2872	TorqueVario®-S VDE, model 1.0-5.0 Nm
	2879	slimTorque VDE bit holder for 6 mm slimBits
	285-900	Torque-Setter
⊕	2831-14	SL/PZ1x75 SL/PZ2x75



**285-900** Torque-Setter.  
**Setting tool for variable torque screwdrivers.**  
**Included in every torque screwdriver delivery.**

Blade: Octagonal blade, through hardened, zinc-plated.

Supplement: Included in every torque screwdriver delivery.

Order-No.	mm	mm	mm
26864	150	80	1

# Wiha Torque VDE screwdrivers.

## slimBits.



**2831-10** SoftFinish® electric slimBit, slotted.  
Individually tested protective insulation 1,000 V AC,  
VDE and GS tested.

Standards: Manufactured acc. to IEC 60900:2012.  
Material: High-quality chrome vanadium steel, through-hardened, bronzed.  
Protective insulation moulded directly onto the bit and completely integrated into the blade in the lower area from size 4.0.  
Application: For all work on or around electrical components up to 1,000 V AC.  
Extra: The integrated protective insulation enables low-lying fastening and spring elements to be reached and manipulated.  
The slim form of the bit allows easy reaching of the screws below the finger and hand guards.  
Attention: 6 mm slimBits only to be used in the slimVario bit holder and slimTorque VDE bit holder (VDE torque system).

Order-No.	⓪	↔	⊖	⓪	max. Nm	⓪
34578	2.5	75	0.4	6.0	0.4	no slim version
34579	3.0	75	0.5	6.0	0.6	no slim version
34580	4.0	75	0.8	6.0	2.5	1
34581	5.5	75	1.0	6.0	5.5	1
34582	6.5	75	1.2	6.0	5.5	1



**2831-11** SoftFinish® electric slimBit, Phillips.  
Individually tested protective insulation 1,000 V AC,  
VDE and GS tested.

Standards: 6 mm slimBits only to be used in the slimVario bit holder and slimTorque VDE bit holder (VDE torque system).

Order-No.	⊕	↔	⓪	max. Nm	⓪
34583	PH1	75	6.0	3.8	1
34584	PH2	75	6.0	5.5	1



**2831-12** SoftFinish® electric slimBit, Pozidriv.  
Individually tested protective insulation 1,000 V AC,  
VDE and GS tested.

Standards: 6 mm slimBits only to be used in the slimVario bit holder and slimTorque VDE bit holder (VDE torque system).

Order-No.	⊕	↔	⓪	max. Nm	⓪
34585	PZ1	75	6.0	3.8	1
34586	PZ2	75	6.0	5.5	1

## slimBits.



**2831-13** SoftFinish® electric slimBit, Xeno, for terminal screws (slotted/Phillips)  
Individually tested protective insulation 1,000 V AC,  
VDE and GS tested.

Standards: 6 mm slimBits only to be used in the slimVario bit holder and slimTorque VDE bit holder (VDE torque system).

Order-No.	⊕	↔	⓪	max. Nm	⓪
34587	SL/PH1	75	6.0	3.8	1
34588	SL/PH2	75	6.0	5.5	1



**2831-14** SoftFinish® electric slimBit for terminal screws (slotted/Pozidriv).  
Individually tested protective insulation 1,000 V AC,  
VDE and GS tested.

Standards: 6 mm slimBits only to be used in the slimVario bit holder and slimTorque VDE bit holder (VDE torque system).

Order-No.	⊕	↔	⓪	max. Nm	⓪
34589	SL/PZ1	75	6.0	3.8	1
34590	SL/PZ2	75	6.0	5.5	1



**2831-15** SoftFinish® electric slimBit, TORX®.  
Individually tested protective insulation 1,000 V AC,  
VDE and GS tested.

Standards: 6 mm slimBits only to be used in the slimVario bit holder and slimTorque VDE bit holder (VDE torque system).

Order-No.	⊕	↔	⓪	max. Nm	⓪
35506	T8	75	6.0	1.3	no slim version
35507	T10	75	6.0	3.8	no slim version
35508	T15	75	6.0	5.0	1
35509	T20	75	6.0	5.5	1
36071	T25	75	6.0	5.5	1



**Safety Notice:**

When working with VDE tools, observe the national safety and accident prevention regulations!



**slimBits.**



**2831-17** SoftFinish® electric slimBit, square (Robertson).  
Individually tested protective insulation 1,000 V AC, VDE and GS tested.

**Standards:** Manufactured acc. to IEC 60900:2012.  
**Material:** High-quality chrome vanadium steel, through-hardened, bronzed. Protective insulation moulded directly onto the bit and completely integrated into the bit in the lower area.  
**Application:** For all work on or around electrical components up to 1,000 V AC.  
**Extra:** The integrated protective insulation enables low-lying fastening and spring elements to be reached and manipulated. The slim form of the bit allows easy reaching of the screws below the finger and hand guards.  
**Attention:** 6 mm slimBits only to be used in the slimVario bit holder and slimTorque VDE bit holder (VDE torque system).

Order-No.	□	↔	⊙	max. Nm	🔩	
35510	Robertson 1	2.3	75	6.0	5.5	1
35511	Robertson 2	2.8	75	6.0	5.5	1



**NEW**  
**2831-18** SoftFinish® electric slimBit, hexagon.  
Individually tested protective insulation 1,000 V AC, VDE and GS tested.

**Standards:** Manufactured acc. to IEC 60900:2012.  
**Material:** High-quality chrome vanadium steel, through-hardened, bronzed. Protective insulation moulded directly onto the bit and completely integrated into the blade in the lower area from size 2.5.  
**Application:** For all work on or around electrical components up to 1,000 V AC.  
**Extra:** The integrated protective insulation enables low-lying fastenings to be reached and manipulated. The slim form of the bit allows easy reaching of the screws below the finger and hand guards.  
**Attention:** 6 mm slimBits only to be used in the slimVario bit holder and slimTorque VDE bit holder (VDE torque system).

Order-No.	⊙	↔	⊙	max. Nm	🔩	
37222	1.5	75	6.0	0.9	no slim version	1
37223	2	75	6.0	1.8	no slim version	1
37224	2.5	75	6.0	3.8		1
37147	3	75	6.0	5.5		1
37225	4	75	6.0	5.5		1
37226	5	75	6.0	5.5		1
37227	6	75	6.0	5.5		1

**slimTorque kit.**



**2879 B7** slimTorque kit, 7-pcs.  
With slimTorque VDE bit holder for 6 mm slimBits.

**Bit holder:** Insulated metal ClicFix bit holder locks all slimBits reliability. Only for 6 mm slimBits.  
**Bits:** Protective insulation moulded directly onto the bit and completely integrated into the bit in the lower area.  
**Bit holder:** Insulated metal ClicFix bit holder locks all slimBits reliability. Only for 6 mm slimBits.  
**Application:** Set for starting Wiha slimTECHNOLOGY, for existing TorqueVario-S VDE torque screwdrivers.  
**Extra:** Individually tested protective insulation 1,000 V AC, VDE and GS tested.

Order-No.	Series	🔩
36079	2879 B7	1
	2879	1xslimTorque VDE bit holder for 6 mm slimBits
	⊙ 2831-10	1x4.0 1x5.5
	⊕ 2831-11	1xPH1 1xPH2
	⊕ 2831-12	1xPZ1 1xPZ2



# Wiha Torque VDE screwdrivers.

## slimTorque starter set.



1000 V  
IEC 60900:2012

2872 T9

slimTorque starter set, 9-pcs.

Torque value can be set via window scale.

With slimTorque VDE bit holder for 6 mm slimBits.

- Handle: VDE torque handle 1.0 - 5.0 Nm, steplessly adjustable with Torque Setter adjusting tool (included in delivery).
- Bit holder: Insulated metal ClicFix bit holder locks all slimBits reliability. Only for 6 mm slimBits.
- Bits: Protective insulation moulded directly onto the bit and completely integrated into the bit in the lower area. Individually tested protective insulation 1,000 V AC, VDE and GS tested.
- Application: For controlled fastening on live parts up to 1 000 V AC.
- Extra: 100% safety from fastening with torque according to specification of manufacturer type-tested switching devices according to EN 60439-1. Effortless access to low-lying fastening elements. Arranged clearly in a high quality, rugged and durable bag.

Order-No.	Series		
36080	2872 T9		1
	2872	1xTorqueVario®-S VDE, model 1.0-5.0 Nm	
	2879	1xslimTorque VDE bit holder for 6 mm slimBits	
	285-900	1xTorque-Setter	
	⓪ 2831-10	1x4.0	1x5.5
	⊕ 2831-11	1xPH1	1xPH2
	⊕ 2831-12	1xPZ1	1xPZ2

## slimTorque starter set.



1000 V  
IEC 60900:2012

2872 T18

slimTorque starter set, 18-pcs.

Torque value can be set via window scale.

With slimTorque VDE bit holder for 6 mm slimBits.

- Handle: VDE torque handle 1.0 - 5.0 Nm, steplessly adjustable with Torque Setter adjusting tool (included in delivery).
- Bit holder: Insulated metal ClicFix bit holder locks all slimBits reliability. Only for 6 mm slimBits.
- Bits: Protective insulation moulded directly onto the bit and completely integrated into the bit in the lower area. Individually tested protective insulation 1,000 V AC, VDE and GS tested.
- Application: For controlled fastening on live parts up to 1 000 V AC.
- Extra: 100% safety from fastening with torque according to specification of manufacturer type-tested switching devices according to EN 60439-1. Effortless access to low-lying fastening elements. Arranged clearly in a high quality, rugged and durable bag.

Order-No.	Series				
36791	2872 T18				1
	2872	1xTorqueVario®-S VDE, model 1.0-5.0 Nm			
	2879	1xslimTorque VDE bit holder for 6 mm slimBits			
	285-900	1xTorque-Setter			
	⓪ 2831-10	1x3.0	2x4.0	2x5.5	1x6.5
	⊕ 2831-12	1xPZ1	2xPZ2		
	⊕ 2831-14	1xSL/PZ1	1xSL/PZ2		
	⊕ 2831-15	1xT10	1xT15	1xT20	1xT25



**Safety Notice:**

When working with VDE tools, observe the national safety and accident prevention regulations!

**slim selection set.****2872 T10****slim selection set, 10-pcs.**

**VDE complete set with torque screwdriver, bit holder and slimBits. Slotted/ Phillips/ Pozidriv.**

- Handle:** VDE torque handle 1.0 - 5.0 Nm, steplessly adjustable.  
Bit holder with SoftFinish® electric multi-component handle.
- Bit holder:** Insulated metal ClicFix bit holder locks all slimBits reliability.  
Only for 6 mm slimBits.
- Bits:** Protective insulation moulded directly onto the bit and completely integrated into the bit in the lower area.  
Individually tested protective insulation 1,000 V AC, VDE and GS tested.
- Application:** For controlled fastening on live parts up to 1 000 V AC.
- Extra:** 100% safety from fastening with torque according to specification of manufacturer type-tested switching devices according to EN 60439-1. Effortless access to low-lying fastening elements. Arranged clearly in a high quality, rugged and durable bag.

Order-No.	Series		
<b>36078</b>	<b>2872 T10</b>		<b>1</b>
	<b>2872</b>	1xTorqueVario®-S VDE, model 1.0-5.0 Nm	
	<b>2831-00</b>	1xSoftFinish® electric slimVario bit holder with handle and ClicFix, 6.0 mm	
	<b>2879</b>	1xslimTorque VDE bit holder for 6 mm slimBits	
	<b>285-900</b>	1xTorque-Setter	
	Ⓢ <b>2831-10</b>	1x4.0	1x5.5
	⊕ <b>2831-11</b>	1xPH1	1xPH2
	⊕ <b>2831-12</b>	1xPZ1	1xPZ2

**slim selection set.****NEW**  
**2872 T11****slim selection set, 11-pcs.**

**VDE complete set with torque screwdriver, bit holder and slimBits.**

- Handle:** VDE torque handle 1.0 - 5.0 Nm, steplessly adjustable.  
Bit holder with SoftFinish® electric multi-component handle.
- Bit holder:** Insulated metal ClicFix bit holder locks all slimBits reliability.  
Only for 6 mm slimBits.
- Bits:** Protective insulation moulded directly onto the bit and completely integrated into the bit in the lower area.  
Individually tested protective insulation 1,000 V AC, VDE and GS tested.
- Application:** For controlled fastening on live parts up to 1 000 V AC.
- Extra:** 100% safety from fastening with torque according to specification of manufacturer type-tested switching devices according to EN 60439-1. Effortless access to low-lying fastening elements. Arranged clearly in a high quality, rugged and durable bag.

Order-No.	Series		
<b>37094</b>	<b>2872 T11</b>		<b>1</b>
	<b>2872</b>	1xTorqueVario®-S VDE, model 1.0-5.0 Nm	
	<b>2831-00</b>	1xSoftFinish® electric slimVario bit holder with handle and ClicFix, 6.0 mm	
	<b>2879</b>	1xslimTorque VDE bit holder for 6 mm slimBits	
	<b>285-900</b>	1xTorque-Setter	
	Ⓢ <b>2831-10</b>	1x4.0	1x5.5
	⊕ <b>2831-11</b>	1xPH1	1xPH2
	⊕ <b>2831-12</b>	1xPZ1	1xPZ2
	⊕ <b>2831-14</b>	1xSL/PZ2	



# Wiha Torque ESD torque range.



TorqueVario®-S ESD with scale.

with scale



2882

**TorqueVario®-S ESD torque screwdriver.**  
Torque value can be set via window scale.  
**Automatic release.**

- Handle:** Torque infinitely adjustable with Torque-Setter setting tool (also supplied).  
Ergonomic multi-component handle, made of ESD-safe dissipative material.  
Handle sizes proportioned to optimise torque setting.  
Audible and perceptible click when the pre-set torque has been attained.  
Surface resistance  $10^6 - 10^9$  ohms.  
Compatible with all blades of the 2889 series.
- Standards:** IEC 61340-5-1.  
EN ISO 6798, BS EN 26789, ASME B107.14M.
- Accuracy:**  $\pm 6\%$ , tracing to national standards (see table for other tolerances).
- Application:** For ESD applications where recommended torque settings are important. Use in combination with a Wiha Torque ESD interchangeable blade.
- Extra:** Delivered in practical plastic box, incl. factory calibration certificate.
- Note:** Bit holders or blades are not included in delivery.  
Further articles can be individualised and set at [mytorque.wiha.com](http://mytorque.wiha.com) or on request.

Order-No.	Nm	±%	⊙	↔	⬇	⬆
36851	0.04-0.46*	10%	4	127	23	1
26865	0.1-0.6	10%	4	127	23	1
36852	0.1-0.6	6%	4	127	23	1
26629	0.4-1.0	6%	4	127	23	1
26866	0.8-2.0	6%	4	131	30	1
30495	1.0-5.0	6%	4	138	36	1

\* Precision in range of 0.1-0.46 Nm

## Wiha TorqueVario®-S ESD with integrated scale.

Specially designed for applications on electrostatic sensitive components and devices that may be damaged by electrostatic fields or discharges. The dissipative handle and blade coating, with a surface resistance of  $10^6 - 10^9$  Ohms, controls electrostatic energy discharge.

Four models cover torque ranges from 0.04 Nm up to 5.0 Nm.



## Wiha Torque ESD torque range.

- Dissipative handle designed to discharge uniformly, surface resistance  $10^6 - 10^9$  ohms
- Meets ESD standard IEC 61340-5-1
- Ergonomic SoftFinish® multi-component handle guarantees comfortable fastening and optimal handling
- Ergonomic handle sizes that are proportional to the torque ranges
- Each tool is individually tested and marked with an identification number
- Clearly audible and perceptible click signal when torque is reached
- Fulfills all accuracy requirements as defined by EN ISO 6789, BS EN 26789 and ASME B 107.14M



**Safety Notice:**

Wiha ESD screwdrivers are noninsulated, therefore not suitable for working on live parts.



**Torque ESD interchangeable blades.**



**2889 Torque ESD slotted interchangeable blade.**  
For Wiha ESD torque screwdrivers.

Blade: High quality chrome-vanadium-molybdenum steel, through hardened, chrome-plated.  
Wiha ChromTop® finish on tip for a perfect fit every time.  
Moulded with static dissipative, black plastic material.  
Surface resistance 10<sup>6</sup> - 10<sup>9</sup> ohms.  
Standards: IEC 61340-5-1, DIN ISO 2380.  
Application: For ESD applications where recommended torque settings are important.

Order-No.	Ø	⌀	●	↔	↔	max. Nm	🔧
26869	0.25	1.5	4	175	42	0.15	10
26870	0.4	2.0	4	175	42	0.4	10
26871	0.5	3.0	4	175	42	0.6	10
26872	0.6	3.5	4	175	42	1.1	10
26873	0.8	4.0	4	175	42	2.5	10



**2889 Torque ESD Phillips interchangeable blade.**  
For Wiha ESD torque screwdrivers.

Blade: IEC 61340-5-1, DIN ISO 8764.

Order-No.	⊕	●	↔	↔	max. Nm	🔧
26877	PH000	4	175	42	0.4	10
26876	PH00	4	175	42	0.4	10
26875	PH0	4	175	42	0.9	10
26878	PH1	4	175	42	3.8	10



**2889 Torque ESD Pozidriv interchangeable blade.**  
For Wiha ESD torque screwdrivers.

Blade: IEC 61340-5-1, DIN ISO 8764.

Order-No.	⊕	●	↔	↔	max. Nm	🔧
26879	PZ0	4	175	42	0.9	10
26880	PZ1	4	175	42	3.8	10



**2889 Torque ESD TORX® interchangeable blade.**  
For Wiha ESD torque screwdrivers.

Blade: IEC 61340-5-1.  
Application: Very slim blade diameter for hard-to-reach screws.

Order-No.	⊕	●	↔	↔	max. Nm	🔧
26881	T5	4	175	42	0.4	10
26882	T6	4	175	42	0.6	10
26868	T7	4	175	42	0.9	10
26883	T8	4	175	42	1.3	10
26884	T9	4	175	42	2.5	10
26885	T10	4	175	42	3.8	10

**ESD bit holder and Torque Setter. Set.**



**2889 Torque ESD bit universal holder.**  
For Wiha ESD torque screwdrivers.  
Suitable for C 6.3 and E 6.3 (1/4") bits.

Blade: High quality chrome-vanadium-molybdenum steel, through hardened, chrome-plated.  
Surface resistance 10<sup>6</sup> - 10<sup>9</sup> ohms.  
Sleeve: Made of stainless steel, moulded with dissipative, black plastic material.  
Application: For ESD applications where recommended torque settings are important.

Order-No.	⊙	●	↔	🔧	🔧
27711	1/4	4	162	11	10



**288-900 Torque-Setter ESD.**  
Setting tool for variable Torque ESD screwdrivers.  
Included in every torque ESD screwdriver delivery.

Blade: Octagonal blade, through hardened, zinc-plated.  
Handle: Made of static dissipative plastic material.  
Standards: IEC 61340-5-1.  
Supplement: Included in every torque screwdriver delivery.

Order-No.	↔	↔	🔧
27279	80	150	1



**2882 S10 TorqueVario®-S ESD torque screwdriver set, 13 pcs.**  
Torque value can be set via window scale.

With universal bit holder and 10 straight-blade/Phillips/Poszdriv/TORX® Standard bits.  
Handle: Model 0.8-2.0 Nm.  
Torque infinitely adjustable with Torque-Setter setting tool (also supplied).  
Ergonomic multi-component handle, made of ESD-safe dissipative material.  
Standards: IEC 61340-5-1.  
EN ISO 6798, BS EN 26789, ASME B107.14M.  
Accuracy: ±6%, traceable to national standards.  
Application: For ESD applications where recommended torque settings are important.

Order-No.	Series	🔧
27687	2882 S10	1
	2882	TorqueVario®-S ESD, model 0.8-2.0 Nm
	2889	Torque ESD bit universal holder
	288-900	Torque-Setter ESD
⊙	7010 Z	4.5x25 5.5x25
⊕	7011 Z	PH0x25 PH1x25
⊕	7012 Z	PZ0x25 PZ1x25
⊕	7015 Z	T7x25 T8x25 T9x25 T10x25

with scale

# Wiha Torque TR.



## Torque value is set without tools

With the Wiha "TorqueVario S TR" variable torque handle, torque values between 2 and 8 Nm are continuously adjustable. Settings are made by using a tool integrated in the handle.

## Reliable torque technology (audible and perceptible)

Overtightening of the pre-set value is therefore eliminated. Release accuracy is  $\pm 6\%$  of the pre-set scale value, as required by EN ISO 6789. To prevent users from breaking the blade or damaging the screw when loosening the screw, the tools limit the tightening torque, as well as apply a special limit to the loosening torque; this is approximately 30% greater than the tightening torque.

## The combination of soft and hard zones eases handling

The ergonomic soft zones ease handling and gripping and enable comfortable and effortless power transmission, even at higher torques.

## Blade locking mechanism to increase product safety

A mechanical blade locking mechanism prevents it from slipping out of the Wiha "Torque TR" handle. Because locking is not mechanical, work is even possible in magnetic or machining environments.

## Optimal handle version for optimal torque

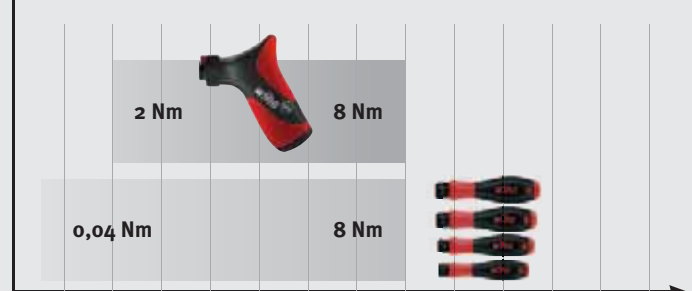

## One blade system for all handles

6-mm interchangeable blades made of high-quality, tough-but flexible chrome-vanadium molybdenum steel are available to match the handles. Two adapter blades for nuts (1/4" and 3/8"), together with a plastic-coated universal bit holder for all C 6.3 and E 6.3 (1/4") bits, complete the product range. Due to the 6mm chuck, the blades are adapted for torques up to 15 Nm.



Can be set without separate tool opening



Distinctly audible and perceptible release signal



Automatic / mechanical blade locking

## 1 tool – several gripping methods



Finely toothed, switchable ratchet (72 teeth) with 5° switching angle



### Wiha Torque TR.

#### Powerful work for applications of up to 8 Nm

- Handle geometry enables force-orientated operation of up to 8 Nm

#### Finely toothed ratchet

- A switching angle of only 5° enables very precise and cramped working

#### Torque value is set without tools

- The torque values can be set continuously between 2 and 8 Nm

#### Reliable torque technology (audible and perceptible)

- Overtightening the screw is eliminated by the reliable torque technology
- Distinctly audible and perceptible click signal
- In accordance with DIN EN ISO 6789 release accuracy of  $\pm 6\%$

#### The combination of soft and hard zones eases handling

- The ergonomic soft zones enable comfortable and effortless power transmission, even at higher torques values

#### Blade locking mechanism to increase product safety

- Suitable even for magnetic or machining environments thanks to mechanical locking

#### One blade system for all handles

- Broad selection of interchangeable blades and adapter blades

# Wiha Torque TR.

## TorqueVario®-S TR.



**NEW**

**28332**

**TorqueVario®-S TR torque tool.**  
Torque value can be set via window scale.  
**Automatic release with ratchet.**

- Handle:** Ergonomic pistol handle for high torques values.  
Axial power transmission.  
Maximum transmission of force due to soft and hard zones.  
Finely toothed ratchet with 72 teeth enables 5° switching angle: guarantees precise work when things get tight.  
Torque can be conveniently set via a setting tool integrated in the handle.  
Audible and perceptible click signal when the pre-set torque has been attained.  
Non-magnetic blade locking.  
Compatible with all blades of the 2899 series.
- Standards:** EN ISO 6798, BS EN 26789, ASME B107.14M.
- Accuracy:** ±6%, traceable to national standards.
- Application:** For applications where recommended torque settings are important.  
Loosening torque approx. +30% greater than tightening torque
- Extra:** Delivered in practical plastic box.  
Incl. factory calibration certificate

Order-No.	Nm	±%	⊙	↺	↻	📦
39777	2-8	6%	6	110	125	1

## TorqueFix® TR and easyTorque TR.



**NEW**

**28330**

**TorqueFix® TR torque tool.**  
With a fixed torque value pre-set by Wiha.  
**Automatic release with ratchet.**

- Handle:** Ergonomic pistol handle for high torques.  
Axial power transmission without breakdown torque.  
Maximum transmission of force due to soft and hard zones.  
Finely toothed ratchet with 72 teeth enables 5° switching angle: guarantees precise work when things get tight.  
Audible and perceptible click signal when the pre-set torque has been attained. Non-magnetic blade locking.  
Compatible with all blades of the 2899 series.
- Standards:** EN ISO 6798, BS EN 26789, ASME B107.14M.
- Accuracy:** ±6%, traceable to national standards.
- Application:** For applications where recommended torque settings are important.  
Loosening torque approx. +30% over torque.
- Extra:** Delivered in practical plastic box.  
Incl. factory calibration certificate

Order-No.	Nm	±%	⊙	↺	↻	📦
38896	6	6%	6	110	125	1
38897	8	6%	6	110	125	1



**NEW**

**28340**

**easyTorque TR torque tool.**  
With a fixed torque value pre-set by Wiha.  
**Automatic release.**

- Handle:** Ergonomic pistol handle for high torques.  
Axial power transmission without breakdown torque.  
Maximum transmission of force due to soft and hard zones.  
Non-magnetic blade locking.  
Audible and perceptible click when the pre-set torque has been attained. Compatible with all blades of the 2899 series.
- Accuracy:** ±10%.
- Application:** For applications where recommended torque settings are important.  
Loosening torque approx. +30% over torque.
- Extra:** Delivered in practical plastic box.
- Note:** Further articles can be individualised and set at [mytorque.wiha.com](http://mytorque.wiha.com) or on request.

Order-No.	Nm	±%	⊙	↺	↻	📦
38890	6	10%	6	110	125	1
38891	8	10%	6	110	125	1



# Wiha T-handle torque tools.

For defined, strong fastening.

## T-handle torque tools with scale.



with scale

**2893** TorqueVario®-STplus T-handle torque tool.  
Torque can be set via numerical scale.  
With slipping clutch.

**Handle:** Window scale displays torque value numerically. Torque infinitely adjustable with Torque-Setter setting tool (also supplied). Soft-grip T-handle for extreme comfort and optimal torque transmission. Audible and perceptible click when the pre-set torque has been attained. Compatible with all blades of the 2899 series.

**Standards:** EN ISO 6798, BS EN 26789, ASME B107.14M.

**Accuracy:** ±6%, traceable to national standards.

**Application:** For applications where recommended torque settings are important. Use in combination with an interchangeable 6 mm blade for Wiha T-handle torque tools.

**Extra:** Delivered in practical plastic box, incl. factory calibration certificate.

Order-No.	Nm	⊙	↔	↕	📦
29233	5-14	6	56	120	1



with scale

**2893 S01** TorqueVario®-STplus T-handle torque tool set, 11 pcs.  
With bit universal holder, 6 TORX®/ hex Standard bits and 2 adapter blades for nuts.

**Handle:** Model 5-14 Nm. Window scale displays torque value numerically. Torque infinitely adjustable with Torque-Setter setting tool (also supplied). Soft-grip T-handle for extreme comfort and optimal torque transmission.

**Standards:** EN ISO 6798, BS EN 26789, ASME B107.14M.

**Accuracy:** ±6%, traceable to national standards.

**Application:** For applications where recommended torque settings are important.

**Extra:** Supply in robust box including works inspection protocol.

Order-No.	Series	📦
29234	2893 S01	1
	2893	TorqueVario®-STplus, model 5-14 Nm
	289-900	Torque-Tplus Setter
	2899	Torque-Tplus adapter blade
	2899	Torque-Tplus bit quick release holder
★	7015 Z	T25x25 T30x25 T40x25
●	7013 Z	4.0x25 5.0x25 6.0x25

## Quick designs. Torque-Tplus Setter.



**2891** TorqueFix®-Tplus T-handle torque tool.  
With a fixed torque value pre-set by Wiha.  
Automatic release. With slipping clutch.

**Handle:** Soft-grip T-handle for extreme comfort and optimal torque transmission. Audible and perceptible click when the pre-set torque has been attained. Compatible with all blades of the 2899 series.

**Standards:** EN ISO 6798, BS EN 26789, ASME B107.14M.

**Accuracy:** ±6%, traceable to national standards.

**Application:** For applications where recommended torque settings are important. Use in combination with an interchangeable 6 mm blade for Wiha T-handle torque tools.

**Extra:** Delivered in practical plastic box, incl. factory calibration certificate.

Order-No.	Nm	⊙	↔	↕	📦
29228	6	6	56	120	1
29229	8	6	56	120	1
29230	10	6	56	120	1
29231	12	6	56	120	1
29236	12.5	6	56	120	1
29232	14	6	56	120	1



**289-900** Torque-Tplus Setter.  
Setting tool for variable T-handle torque tools.  
Included in every T-handle torque tool delivery.

**Blade:** Octagonal profile with drilled tip, through hardened, zinc-plated.

**Handle:** Made of impact resistant cellulose acetate.

Order-No.	↔	↕	📦
28691	80	150	1

# Wiha T-handle torque tools.

## Interchangeable blades.



### 2899 Torque-Tplus hex interchangeable blade. For T-handle torque tools.

Blade: High quality chrome-vanadium-molybdenum steel, through hardened, chrome-plated.  
Wiha ChromTop® finish on tip for a perfect fit every time.  
Colour-coding: red.

Application: For applications where recommended torque settings are important.

Order-No.	Hex	Length	Width	max. Nm	max. in.lbs.	Icon	
28746	3	6	130	53	5.5	49	10
28747	4	6	130	53	15	132	10
28748	5	6	130	53	15	132	10
28749	6	6	130	53	15	132	10



### 2899 Torque-Tplus TORX® interchangeable blade. For T-handle torque tools.

Blade: High quality chrome-vanadium-molybdenum steel, through hardened, chrome-plated.  
Wiha ChromTop® finish on tip for a perfect fit every time.  
Colour-coding: dark green.

Application: For applications where recommended torque settings are important.

Order-No.	TORX	Length	Width	max. Nm	max. in.lbs.	Icon	
28734	T15	6	130	53	5.5	49	10
28735	T20	6	130	53	10	88	10
28736	T25	6	130	53	15	132	10
28737	T27	6	130	53	15	132	10
28738	T30	6	130	53	15	132	10
28739	T40	6	130	53	15	132	10



### 2899 Torque-Tplus TORX PLUS® interchangeable blade. For T-handle torque tools.

Blade: High quality chrome-vanadium-molybdenum steel, through hardened, chrome-plated.  
Wiha ChromTop® finish on tip for a perfect fit every time.  
Colour-coding: light green.

Application: For applications where recommended torque settings are important.

Order-No.	TORX PLUS	Length	Width	max. Nm	max. in.lbs.	Icon	
28740	15IP	6	130	53	6.6	59	10
28741	20IP	6	130	53	13	115	10
28742	25IP	6	130	53	15	132	10
28743	27IP	6	130	53	15	132	10
28744	30IP	6	130	53	15	132	10
28745	40IP	6	130	53	15	132	10

## Interchangeable blades.



### NEW 28339-91 Torque TR / Topra 2K bit universal holder. Accommodates 1/4" bits.

Blade: High quality chrome-vanadium molybdenum steel.  
Application: For applications where recommended torque settings are important.

Order-No.	Hex	Length	Width	Icon	Icon
39255	1/4	45	6	11.4	1



### 2899 Torque-Tplus bit quick release holder. For T-handle torque tools. Suitable for C 6.3 and E 6.3 (1/4") bits.

Blade: High quality chrome-vanadium-molybdenum steel, through hardened, chrome-plated.  
Sleeve: Quick release bit holder for T-handle torque tools. Enables ultra fast bit changes.  
Application: For controlled turning of screws with bits at a prescribed torque.

Order-No.	Hex	Length	Width	Icon	Icon
28758	1/4	6	125	11	10



### NEW 28339 Torque TR / Topra 2K adapter blade. Suitable for 1/4" resp. 3/8" square sockets.

Blade: High quality chrome-vanadium molybdenum steel.  
Application: For controlled turning of screws with nuts at a prescribed torque.

Order-No.	Hex	Length	Width	Icon	Icon
39256	1/4	52	6	1	1
39257	3/8	52	6	1	1



### 2899 Torque-Tplus adapter blade. For T-handle torque tools. Suitable for 1/4" resp. 3/8" square sockets.

Blade: High quality chrome-vanadium-molybdenum steel, through hardened, chrome-plated.  
Head: Nickel-plated, spring-mounted ball.  
Application: For controlled turning of screws with nuts at a prescribed torque.

Order-No.	Hex	Length	Width	Icon	Icon
28756	1/4	6	120	53	10
28757	3/8	6	120	53	10

# Wiha TorqueVario®-S TR VDE.



## TorqueVario®-S TR VDE.



with scale

**NEW**  
28372



**TorqueVario®-S TR VDE torque tool.**  
For individually tested VDE torque blades of the 28379 series.  
Torque value can be set variably using a numeric scale.

**Automatic release with ratchet.**

- Handle: Ergonomic pistol handle for high torques.  
Axial power transmission.  
Maximum transmission of force due to soft and hard zone.  
Finely toothed ratchet with 72 teeth enables 5° switching angle: guarantees precise work when things get tight.  
Torque can be conveniently set via a setting tool integrated in the handle. Audible and perceptible click when the pre-set torque has been attained. Non-magnetic blade locking.  
Compatible with all VDE torque blades of the 28379 series.
- Standards: EN ISO 6798, BS EN 26789, ASME B107.14M.
- Accuracy: ±6%, traceable to national standards.
- Application: For applications where recommended torque settings are important.  
Loosening torque approx. +30% greater than tightening torque.
- Extra: Delivered in practical plastic box.  
Incl. factory calibration certificate



Order-No.	Nm	±%	Ø	↔	↔	↔
39819	2-8	6%	6	110	125	1

## Torque-TR electric interchangeable blades.



**NEW**  
28379



**Torque TR electric interchangeable blade, hex nut driver.**  
Individually tested protective insulation 1,000 V AC, VDE and GS tested.

- Blade: High quality chrome-vanadium-molybdenum steel, through hardened, black-finish. Insulation moulded directly onto the blade.
- Standards: Manufactured according to IEC 60900:2012.
- Application: For all work on or around electrical components up to 1,000 V AC.

Order-No.	Ø	↔	↔	max. Nm	↔	↔
38925	7.0	132	5	14,5	10	
38926	8.0	132	10	15,2	10	
38927	9.0	132	14	16,0	10	
38928	10.0	132	17	17,2	10	
38929	13.0	132	20	22,2	10	
38930	17.0	132	20	27,2	10	



**NEW**  
28379



**Torque TR electric interchangeable blade, hex.**  
Individually tested protective insulation 1,000 V AC, VDE and GS tested.

- Blade: High quality chrome-vanadium-molybdenum steel, through hardened, black-finish. Insulation moulded directly onto blade.
- Standards: Manufactured according to IEC 60900:2012.
- Application: For all work on or around electrical components up to 1,000 V AC.

Order-No.	Ø	↔	↔	max. Nm	↔
38918	3.0	132	35	5.5	10
38919	4.0	132	35	15	10
38920	5.0	132	35	20	10
38921	6.0	132	35	20	10



**NEW**  
28379



**Torque TR electric interchangeable blade, TORX®.**  
Individually tested protective insulation 1,000 V AC, VDE and GS tested.

- Blade: High quality chrome-vanadium-molybdenum steel, through hardened, black-finish. Insulation moulded directly onto blade.
- Standards: Manufactured according to IEC 60900:2012.
- Application: For all work on or around electrical components up to 1,000 V AC.

Order-No.	Ø	↔	↔	max. Nm	↔
38931	T15	132	35	5,5	10
38932	T20	132	35	10	10
38933	T25	132	35	15	10
38934	T27	132	35	15	10
38935	T30	132	35	20	10
38936	T40	132	35	20	10

# Wiha TorqueFix®-Key.

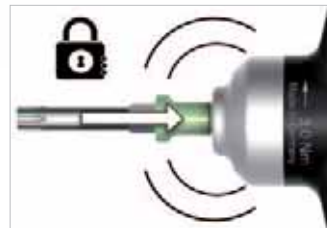

Wiha TorqueFix®-Key.

## Compact torque tool

The TorqueFix-Key is an extremely compact torque tool with pre-set torque values between 0.5 Nm and 4.0 Nm. The tool is especially developed for applications in which users only have little space for fastening.

## Extra slim blade geometry

With the "TorqueFix-Key", the entire system is designed for applications in tight spots. Like the key, the blade is also perfectly adapted to the work scenario. This is achieved with a significantly shortened blade length in combination with an extra slim blade diameter.

## Quick-turning zone

The torque tool features a quick-turning zone, which enables fast and time-saving work.

## Reliable torque technology

Overtightening of the pre-set value is therefore eliminated. Release accuracy is  $\pm 6\%$  of the pre-set scale value, as required by EN ISO 6789. To prevent users from breaking the blade or damaging the screw when loosening the screw, the tools limit the tightening torque, as well as apply a special limit to the loosening torque; this is approximately 30% greater than the tightening torque.

## Blade assortment

A 4 mm interchangeable blades made of high-quality, tough-but-flexible chrome-vanadium-molybdenum steel are available for the "TorqueFix-Key".

## Small & compact

- Ergonomic key handle, extremely handy thanks to its compact design.
- Torque tool for very tight machine assembly spaces.

## Extra slim blade geometry

- Very slim blade diameter for hard-to-reach screws.

## Rapid handling

- Time-saving work due to twist zone in the handle area.

## Individual unit testing with calibration certificate

- Distinctly audible and perceptible release signal.
- Release accuracy  $\pm 6\%$ .
- Loosening torque approx +30% greater than tightening torque.

## Flexible and economic due to interchangeable blades

- Non-magnetic blade clamping specifically for cutting processes.

## TorqueFix®-Key.



NEW

2836

**TorqueFix® key torque screwdriver.****With a fixed torque value pre-set by Wiha.****Automatic release.**

Handle: Ergonomic key handle, extremely handy thanks to its compact design. Specially for hard-to-reach screws and confined spaces.

Audible and perceptible click when the pre-set torque has been attained.

Compatible with all blades of the 2859 series.

Standards: EN ISO 6798, BS EN 26789, ASME B107.14M.

Accuracy: ±6%, traceable to national standards.

Application: For applications where recommended torque settings are important. Loosening torque approx. +30% greater than tightening torque.

Extra: Delivered in practical plastic box.

Incl. factory calibration certificate.

Note: Further articles can be individualised and set at [mytorque.wiha.com](http://mytorque.wiha.com) or on request.

Order-No.	Nm	±%	⊙	↔	↔	↔
38616	0.5	6%	4	68	50	1
38617	0.6	6%	4	68	50	1
38618	0.9	6%	4	68	50	1
38556	1.1	6%	4	68	50	1
38800	1.2	6%	4	68	50	1
38619	1.4	6%	4	68	50	1
38557	2.0	6%	4	68	50	1
38620	2.5	6%	4	68	50	1
38621	3.0	6%	4	68	50	1
38558	3.8	6%	4	68	50	1
38622	4.0	6%	4	68	50	1

## Torque interchangeable blades.



NEW

28369

**Torque hex interchangeable blade.****For Wiha TorqueFix® key torque screwdrivers.**

Blade: High-quality chrome-vanadium molybdenum steel, through-hardened, titanium silver.

Application: For applications where recommended torque settings are important.

Extra: Very slim blade diameter for hard-to-reach screws.

Order-No.	⊙	⊙	↔	↔	max. Nm	↔
38801	1.5	4	75	20	0.9	10
38802	2.0	4	75	20	1.8	10
38803	2.5	4	75	20	3.8	10
38804	3.0	4	75	20	5.5	10
38805	4.0	4	75	20	8.0	10



NEW

28369

**Torque TORX® interchangeable blade.****For Wiha TorqueFix® key torque screwdrivers.**

Blade: High-quality chrome-vanadium molybdenum steel, through-hardened, titanium silver.

Application: For applications where recommended torque settings are important.

Extra: Very slim blade diameter for hard-to-reach screws.

Order-No.	⊙	⊙	↔	↔	max. Nm	↔
38806	T6	4	75	20	0.6	10
38807	T7	4	75	20	0.9	10
38808	T8	4	75	20	1.3	10
38809	T9	4	75	20	2.5	10
38810	T10	4	75	20	3.8	10
38811	T15	4	75	20	5.5	10
38812	T20	4	75	20	8.0	10
38813	T25	4	75	20	8.0	10



NEW

28369

**Torque TORX PLUS® interchangeable blade.****For Wiha TorqueFix® key torque screwdrivers.**

Blade: High-quality chrome-vanadium molybdenum steel, through-hardened, titanium silver.

Application: For applications where recommended torque settings are important.

Extra: Very slim blade diameter for hard-to-reach screws.













Order-No.	⊙	⊙	↔	↔	max. Nm	↔
38814	6IP	4	75	20	0.8	10
38815	7IP	4	75	20	1.3	10
38816	8IP	4	75	20	2.0	10
38817	9IP	4	75	20	3.0	10
38818	10IP	4	75	20	4.5	10
38819	15IP	4	75	20	6.6	10
38820	20IP	4	75	20	8.0	10
38821	25IP	4	75	20	8.0	10



# Wiha reversible blade systems.

Flexible, versatile exchange tools.



	 Slotted	 Phillips PH	 Xeno SL/PH	 Pozidriv PZ	 Xeno SL/PZ	 TORX®	 TORX® Tamper Resistant	 TORX PLUS®	 For internal hex	 For hex nuts	 For internal square	 Tri-Wing®	 Torq-Set®	
<b>SYSTEM 6</b>	112, 114-117	112/114, 116-117		112, 114-117		112, 114-117	113/115		112, 114-117	112-113, 115		113/115	113/115	
<b>SYSTEM 4</b>	119/121-123	119/121-123		119		120-123			120-123	120				

## Reversible blade systems assortment



<b>Wiha SYSTEM 6.</b>		
The space-saving all-rounder. ....	110	
SYSTEM 6 SoftFinish®-telescopic .....	111	
SYSTEM 6 SoftFinish®-telescopic ESD .....	111	
SYSTEM 6 Topra 2K .....	111	<b>NEW</b>
SYSTEM 6 magnetic handle .....	111	
SYSTEM 6 reversible blades .....	112–113	
SYSTEM 6 sets .....	114–117	



<b>Wiha SYSTEM 4.</b>		
Ideal for precision work. ....	118	
SYSTEM 4 SoftFinish®-telescopic .....	119	
SYSTEM 4 SoftFinish®-telescopic ESD .....	119	
SYSTEM 4 reversible blades .....	119–120	
SYSTEM 4 sets .....	121–123	



# Wiha SYSTEM 6.

The space-saving all-rounder.



Are you looking for a versatile and space-saving system for your toolbox or for use on the road?

Then our **SYSTEM 6** exchange tools with 6 mm reversible blades and suitable handles are exactly the right solution for you. Just select the right variations for your application among the wide choice of handles and reversible blades or simply decide for one of the **SYSTEM 6** sets.

- The starter sets with tough roll-up bag are already equipped with the most common reversible blades, but also offer room for a maximum of 11 further reversible blades.
- The extensive professional sets are the perfect solution if you need a professional universal set in a rigid box.
- The practical roll-up bag sets are especially handy and space-saving.

The Wiha **SYSTEM 6** reversible blade systems are high quality products with industrial quality that fulfill maximum demands thanks to first class materials and manufacturing. The 150 mm long reversible blades are manufactured from chrome-vanadium molybdenum steel and are through hardened. The various handles are particularly ergonomically designed and guaranteeing optimal power transmission.

With the Wiha **SYSTEM 6** series you always have the right tool on hand for a wide range of applications - ideal for industry, trade and the ambitious handymen.



*The Wiha SYSTEM 6 range is the compact all-rounder for different applications.*

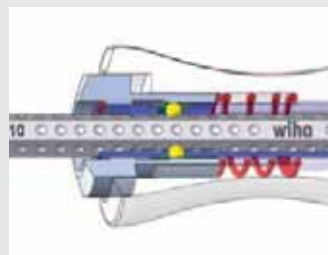

*Thanks to the ClickStop ball clamp in each telescopic handle, 24 different visible blade lengths can be set between 42 and 114 mm in 3 mm increments.*



## Wiha SYSTEM 6.

- Versatile reversible blade system in industrial quality
- Expandable individual tool system
- Ergonomic handles for almost every application
- Blades of high-quality, tough yet elastic chrome-vanadium-molybdenum steel, through hardened
- Titanium silver surface for high corrosion protection

## SYSTEM 6 handles.

**284** SYSTEM 6 SoftFinish®-telescopic handle.  
**Ergonomic multi-component handle with roll-off protection.**

Handle: With 6 mm hex retainer.  
 Enables adjustable blade lengths from 42 - 114 mm.  
 ClickStop ball clamp guarantees a secure hold and rapid blade exchange.

Application: Versatile for general applications in the workshop and factory.

Order-No.	⊙	↔	↕	▬
30372	6.0	120	36	5

**SB 284** SYSTEM 6 SoftFinish®-telescopic handle.  
**Blister packed.**

Order-No.	⊙	↔	↕	▬
30404	6.0	120	36	1

**284ESD** SYSTEM 6 SoftFinish®-telescopic ESD handle.  
**Dissipative handle, ESD-safe.**

Handle: Ergonomic multi-component handle with roll-off protection.  
 With 6 mm hex retainer.  
 Enables adjustable blade lengths from 42 - 114 mm.  
 ClickStop ball clamp guarantees a secure hold and rapid blade exchange.

Surface resistance  $10^6 - 10^9$  ohms.

Standards: IEC 61340-5-1.

Application: For working on electrostatically sensitive components.

Order-No.	⊙	↔	↕	▬
31496	6.0	120	36	5



**Safety Notice:**  
 Wiha ESD screwdrivers are non-insulated,  
 therefore not suitable for working on live parts.

## SYSTEM 6 handles.

**NEW**  
**2820 00** SYSTEM 6 Topra 2K pistol ratchet.  
**For all SYSTEM 6 reversible blades.**

Blade: Complete range of all SYSTEM 6 reversible blades can be used.  
 Ball latch for a secure hold of all reversible blades.

Handle: Ergonomic pistol handle for high torques.  
 Axial power transmission without breakdown torque.  
 Maximum transmission of force due to soft and hard zones which are adapted to the users palm.  
 Finely serrated ratchet with 72 teeth enables 5° switching angle:  
 guarantees precise work when things get tight.

Application: Low range of motion for quick work, e.g. in 2-finger access.  
 Turbo wheel for extremely fast turning of metal screws and bolts.  
 Fast and powerful fastening even of larger screws, e.g. M8 and M10.  
 Thus, any screw up to M10 can be moved using SYSTEM 6 reversible blades.

Order-No.	⊙	↔	↕	▬
38914	6.0	107	121	5

**481 M01** SYSTEM 6 Magnetic handle.  
**With built-in magnetiser/ demagnetiser.**

Handle: With built-in magnetiser/ demagnetiser.  
 With hex bolster for additional torque.  
 Use in combination with SYSTEM 6 reversible blades.

Application: For magnetising/ demagnetising SYSTEM 6 reversible blades.

Order-No.	⊙	↔	↕	▬
27625	6.0	110	33	5

# Wiha SYSTEM 6.

The space-saving all-rounder.

## SYSTEM 6 reversible blades.



### 284 SYSTEM 6 slotted reversible blade.

Blade: High quality CVM steel, through hardened.  
Titanium silver, laserd tip sizes.

Order-No.	⌀	⌀	⊖	⊖	↔	⬠	⬢
27627	3.5	4.5	0.6	0.8	150	6.0	5
00629	4.0	6.0	0.8	1.0	150	6.0	5
00630	5.5	6.5	1.0	1.2	150	6.0	5
36084	8.0	-	1.2	-	150	6.0	5



### 284 SYSTEM 6 combined slotted-Phillips reversible blade.

Blade: High quality CVM steel, through hardened.  
Titanium silver, laserd tip sizes.

Order-No.	⌀	⊕	⊖	↔	⬠	⬢
00665	4.0	PH1	0.8	150	6.0	5
00666	6.0	PH2	1.0	150	6.0	5
00667	6.5	PH3	1.2	150	6.0	5



### 284 SYSTEM 6 Phillips reversible blade.

Blade: High quality CVM steel, through hardened.  
Titanium silver, laserd tip sizes.

Order-No.	⊕	⊕	↔	⬠	⬢
00631	PH1	PH2	150	6.0	5
27628	PH2	PH3	150	6.0	5



### 284 SYSTEM 6 Pozidriv reversible blade.

Blade: High quality CVM steel, through hardened.  
Titanium silver, laserd tip sizes.

Order-No.	⊕	⊕	↔	⬠	⬢
00632	PZ1	PZ2	150	6.0	5
27629	PZ2	PZ3	150	6.0	5

## Wiha Info

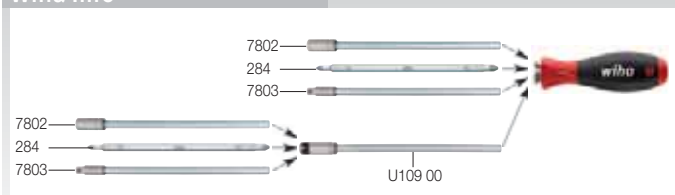

Suitable for every use:  
the blades can be quickly combined,  
extended and interchanged.

## SYSTEM 6 reversible blades.



### 284 SYSTEM 6 combined ball end hex - hex reversible blade.

Blade: High quality CVM steel, through hardened.  
Titanium silver, laserd tip sizes.

Extra: The ball end enables the user to work at angles up to 25°.

Order-No.	⌀	⌀	↔	⬠	⬢
00635	2.5	2.5	150	6.0	5
00636	3	3	150	6.0	5
00637	4	4	150	6.0	5
00638	5	5	150	6.0	5
00639	6	6	150	6.0	5



## NEW

### U 106 SYSTEM 6 hex nut driver blade.

For hex nuts.

Blade: High quality CVM steel, through hardened.  
Titanium silver, stamped tip sizes.

Order-No.	⌀	↔	⬠	⬢
08900	4.0	150	6.0	5
08901	4.5	150	6.0	5
08902	5.0	150	6.0	5
08903	5.5	150	6.0	5
08904	6.0	150	6.0	5
08905	7.0	150	6.0	5
08906	8.0	150	6.0	5
08907	9.0	150	6.0	5
08908	10.0	150	6.0	5
08909	11.0	150	6.0	5
08911	13.0	150	6.0	5



### 284 SYSTEM 6 TORX® reversible blade.

Blade: High quality CVM steel, through hardened.  
Titanium silver, laserd tip sizes.

Order-No.	⬠	⬠	↔	⬠	⬢
00654	T6	T8	150	6.0	5
00655	T7	T9	150	6.0	5
00656	T10	T15	150	6.0	5
00657	T20	T25	150	6.0	5
00658	T30	T40	150	6.0	5



## SYSTEM 6 reversible blades.

**284** SYSTEM 6 TORX® Tamper Resistant reversible blade.  
For TORX® screws with locking pin.

Blade: High quality CVM steel, through hardened.  
Titanium silver, laserd tip sizes.  
With borehole in the blade tip.

Order-No.								
27630	T6H	T8H	150	6.0				
27631	T7H	T9H	150	6.0				
27632	T10H	T15H	150	6.0				
27633	T20H	T25H	150	6.0				
27634	T30H	T40H	150	6.0				

**284** SYSTEM 6 Tri-Wing® reversible blade.  
For Tri-Wing® security screws.

Blade: High quality CVM steel, through hardened.  
Titanium silver, laserd tip sizes.

Order-No.						
27637	TW0	TW1	150	6.0		
27638	TW2	TW3	150	6.0		
27639	TW4	TW5	150	6.0		

**284** SYSTEM 6 Torq-Set® reversible blade.  
For Torq-Set® security screws.

Blade: High quality CVM steel, through hardened.  
Titanium silver, laserd tip sizes.

Order-No.				
27635	TS2	TS4	150	6.0
27636	TS6	TS8	150	6.0

**U109 00** SYSTEM 6 extension blade.  
Suitable for blades.

Blade: Chrome-vanadium steel, through hardened. Titanium silver.  
Extends all SYSTEM 6 blades up to 100 mm.

Order-No.				
08921	6.0	150	6.0	11

## Wiha Info

## Did you already know?

TORX® Tamper Resistant screwdrivers can also be used for TORX® screws, but not vice versa.

## SYSTEM 6 reversible blades.

**7802** SYSTEM 6 bit holder.  
Suitable for C 6.3 and E 6.3 (1/4") bits.

Blade: Chrome-vanadium steel, through hardened. Titanium silver.  
Bit retainer made of stainless steel with integrated permanent magnet.

Order-No.				
03882	1/4	150	6.0	10

**7803** SYSTEM 6 adapter blade.  
Suitable for 1/4" square sockets.

Blade: Chrome-vanadium steel, through hardened. Titanium silver.  
1/4" square drive with ball retainer.

Order-No.			
03883	1/4	150	6.0

**NEW**  
**28339-91** Torque TR / Topra 2K universal bit holder.  
Accommodates 1/4" bits.

Blade: High quality CVM steel.  
Application: For applications where recommended torque settings are important.

Order-No.				
39255	1/4	45	6	11.4

**NEW**  
**28339-92** Torque TR / Topra 2K adapter blade.  
Suitable for 1/4" resp. 3/8" square sockets.

Blade: High quality CVM steel.  
Application: For controlled turning of screws with nuts at a prescribed torque.

Order-No.			
39256	1/4	52	6
39257	3/8	52	6

**NEW**  
**28339-94** SYSTEM 6 adapter Topra 2K  
Insertion of SYSTEM 6 blades.

Blade: High quality CVM steel.

Order-No.			
39383	6	58.5	6

# Wiha SYSTEM 6.

The space-saving all-rounder.

## SYSTEM 6 Starter sets.



**281 T6** SYSTEM 6 reversible blades set, 6 pcs.  
Slotted/ Phillips/ hex/ ball end hex.

Blade: High quality CVM steel, through hardened. Titanium silver, laserd tip sizes. Blade length is adjustable from 42 - 114 mm.

Handle: SYSTEM 6 SoftFinish®-telescopic handle. ClickStop ball clamp guarantees a secure hold and rapid blade exchange.

Application: Versatile and space-saving, it fits in every toolbox.

Extra: Robust roll-up pouches allows space-saving storage of tools.

Order-No.	Series				
27715	281 T6				1
	284	SYSTEM 6 SoftFinish®-telescopic handle			
⓪	⓪ 284	3.5 - 4.5	4.0 - 6.0	5.5 - 6.5	
⊕	⊕ 284	PH1 - PH2			
⊗	⊗ 284	5 - 5			

## SYSTEM 6 sets.



**281 T11** SYSTEM 6 reversible blades set, 11 pcs.  
Slotted/ Phillips/ Pozidriv/ TORX®/ hex/ ball end hex.

Blade: High quality CVM steel, through hardened. Titanium silver, laserd tip sizes. Blade length is adjustable from 42 - 114 mm.

Handle: SYSTEM 6 SoftFinish®-telescopic handle. ClickStop ball clamp guarantees a secure hold and rapid blade exchange.

Extra: Robust roll-up pouches allows space-saving storage of tools.

Order-No.	Series				
03591	281 T11				1
	284	SYSTEM 6 SoftFinish®-telescopic handle			
⓪	⓪ 284	4.0 - 6.0	5.5 - 6.5		
⊕	⊕ 284	PH1 - PH2			
⊗	⊗ 284	PZ1 - PZ2			
⊛	⊛ 284	T10 - T15	T20 - T25	T30 - T40	
⊙	⊙ 284	4 - 4	5 - 5	6 - 6	



**281 T6 01** SYSTEM 6 reversible blades set, 6 pcs.

Blade: High quality CVM steel, through hardened. Titanium silver, laserd tip sizes. Blade length is adjustable from 42 - 114 mm.

Handle: SYSTEM 6 SoftFinish®-telescopic handle. ClickStop ball clamp guarantees a secure hold and rapid blade exchange.

Application: Versatile and space-saving, it fits in every toolbox.

Extra: Robust roll-up pouches allows space-saving storage of tools.

Order-No.	Series				
32298	281 T6 01				1
	284	SYSTEM 6 SoftFinish®-telescopic handle			
⓪	⓪ 284	4.0 - 6.0			
⊕	⊕ 284	PH1 - PH2			
⊗	⊗ 284	PZ1 - PZ2			
⊛	⊛ 284	T10 - T15	T20 - T25		

## Wiha Info

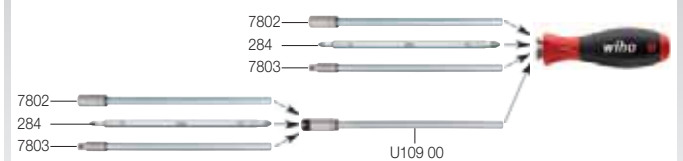

Suitable for every use:  
the blades can be quickly combined,  
extended and interchanged.

## SYSTEM 6 sets.



Telescopic

**U106 T8** SYSTEM 6 nut driver set, 8 pcs.**Nut driver.**

Blade: Chrome-vanadium molybdenum steel, through hardened.  
Titanium silver, stamped tip sizes.  
Blade length is adjustable from 42 - 114 mm.

Handle: SYSTEM 6 SoftFinish®-telescopic handle.  
ClickStop ball clamp guarantees secure hold and a quick nut driver change.

Extra: Robust roll-up pouches allows space-saving storage of tools.

Order-No.	Series	
27712	<b>U106 T8</b>	1
	<b>284</b>	SYSTEM 6 SoftFinish®-telescopic handle
	<b>U 106</b>	5.0 5.5 6.0 7.0 8.0 10.0 13.0



Telescopic

**U106 T12** SYSTEM 6 nut driver set, 12 pcs.**Nut driver.**

Blade: Chrome-vanadium molybdenum steel, through hardened.  
Titanium silver, stamped tip sizes.  
Blade length is adjustable from 42 - 114 mm.

Handle: SYSTEM 6 SoftFinish®-telescopic handle.  
ClickStop ball clamp guarantees secure hold and a quick nut driver change.

Extra: Robust roll-up pouches allows space-saving storage of tools.

Order-No.	Series	
27713	<b>U106 T12</b>	1
	<b>284</b>	SYSTEM 6 SoftFinish®-telescopic handle
	<b>U 106</b>	4.0 4.5 5.0 5.5 6.0 7.0 8.0 9.0 10.0 11.0 13.0

## SYSTEM 6 professional sets.



Telescopic

**281 B11** SYSTEM 6 reversible blades set, 11 pcs.  
Slotted/ Phillips/ Pozidriv/ TORX®/ hex/ ball end hex.

Blade: High quality CVM steel, through hardened.  
Titanium silver, laserd tip sizes.  
Blade length is adjustable from 42 - 114 mm.

Handle: SYSTEM 6 SoftFinish®-telescopic handle.  
ClickStop ball clamp guarantees a secure hold and rapid blade exchange.

Application: Set in a rigid box for professional applications.

Order-No.	Series	
00623	<b>281 B11</b>	1
	<b>284</b>	SYSTEM 6 SoftFinish®-telescopic handle
①	① <b>284</b>	4.0 - 6.0 5.5 - 6.5
⊕	⊕ <b>284</b>	PH1 - PH2
⊕	⊕ <b>284</b>	PZ1 - PZ2
⊗	⊗ <b>284</b>	T10 - T15 T20 - T25 T30 - T40
⊙	⊙ <b>284</b>	4 - 4 5 - 5 6 - 6



Telescopic

**281 B11 01** SYSTEM 6 reversible blades set, 11 pcs.  
Tri-Wing®/ Torq-Set®/ TORX® Tamper Resistant.

Blade: High quality CVM steel, through hardened.  
Titanium silver, laserd tip sizes.  
Blade length is adjustable from 42 - 114 mm.

Handle: SYSTEM 6 SoftFinish®-telescopic handle.  
ClickStop ball clamp guarantees a secure hold and rapid blade exchange.

Application: Set for safety screws in a rigid box.

Order-No.	Series	
27714	<b>281 B11 01</b>	1
	<b>284</b>	SYSTEM 6 SoftFinish®-telescopic handle
⊗	⊗ <b>284</b>	TW0 - TW1 TW2 - TW3 TW4 - TW5
⊕	⊕ <b>284</b>	TS2 - TS4 TS6 - TS8
⊗	⊗ <b>284</b>	T6H - T8H T7H - T9H T10H - T15H T20H - T25H T30H - T40H

# Wiha SYSTEM 6.

The space-saving all-rounder.

## SYSTEM 6 display.



Telescopic

**284 VB1** SYSTEM 6 display.  
Acryl glass display with 85 pieces.  
Size: 22 x 19 x 35 cm (WxDxH).

Order-No.	Series					
36095	284 VB1	1				
	284	4xSYSTEM 6 SoftFinish®-telescopic handle				
①	① 284	4x6.0				
①	① 284	7x4.0	7x5.5	7x8.0		
⊕	⊕ 284	7xPH1				
⊕	⊕ 284	7xPZ1				
●	● 284	7x2.5	7x3	7x4	7x5	
●	● 284	7xT10	7xT20			

## SYSTEM 6 ESD set.



Telescopic

**284ESD T6 01** SYSTEM 6 ESD set of reversible blades, 6 pcs.  
Slotted/ Phillips/ hex/ ball end hex.

Blade: High quality CVM steel, through hardened.  
Titanium silver, laserd tip sizes.  
Blade length is adjustable from 42 - 114 mm.

Handle: SYSTEM 6 SoftFinish®-telescopic ESD handle.  
ESD-safe (dissipative), surface resistance  $10^6 - 10^9$  ohms.  
ClickStop ball clamp guarantees a secure hold and rapid blade exchange.

Packaging: Blister packed.  
Extra: Robust roll-up pouches allows space-saving storage of tools.

Order-No.	Series			
31497	284ESD T6 01	1		
	284ESD	SYSTEM 6 SoftFinish®-telescopic ESD handle		
①	① 284	3.5 - 4.5	4.0 - 6.0	5.5 - 6.5
⊕	⊕ 284	PH1 - PH2		
●	● 284	5 - 5		

## Wiha Info



Press sleeve:  
=> Blade lock is released



Press and hold down sleeve:  
=>Set desired blade length



Release sleeve:  
=>Blade is held securely

## SYSTEM 6 Magnetic set.

**481 T6** SYSTEM 6 reversible blades set, 6 pcs.

Slotted/ Phillips/ hex/ ball end hex.

Blade: High quality CVM steel, through hardened.  
Titanium silver, laserd tip sizes.Handle: SYSTEM 6 Magnetic handle.  
With built-in magnetiser/ demagnetiser.

Application: Versatile and space-saving, it fits in every toolbox.

Extra: Robust roll-up pouches allows space-saving storage of tools.

Order-No.	Series			
27717	481 T6			1
	481 M01	SYSTEM 6 Magnetic handle		
①	① 284	3.5 - 4.5	4.0 - 6.0	5.5 - 6.5
⊕	⊕ 284	PH1 - PH2		
●	● 284	5 - 5		

## SYSTEM 6 Topra 2K sets.



Available from June 2014

**NEW****2820 B11** SYSTEM 6 reversible blades set, 11 pcs.  
Slotted/ Phillips/ Pozidriv/ TORX®/ hex/ ball end hex.Blade: High quality CVM steel, through hardened.  
Titanium silver, laserd tip sizes.Handle: SYSTEM 6 Topra 2K pistol ratchet.  
Ergonomic pistol handle for high torques.  
Maximum transmission of force due to soft and hard zones which are adapted to the users palm.

Application: Set with pistol handle and blades in a rigid box for professional use.

Order-No.	Series			
39125	2820 B11			1
	2820 00	SYSTEM 6 Topra 2K pistol ratchet		
	28339-91	universal bit holder		
①	① 284	4.0 - 6.0	5.5 - 6.5	
⊕	⊕ 284	PH1 - PH2		
⊕	⊕ 284	PZ1 - PZ2		
✱	✱ 284	T10 - T15	T20 - T25	T30 - T40
●	● 284	4 - 4	5 - 5	6 - 6

## Wiha Info

**SYSTEM 6 Magnetic.**

The ideal set for magnetising or demagnetising screwdriver blades and similar tools made of steel.



# Wiha SYSTEM 4.

Ideal for precision work.



Colour-coded ChromTop® tips for maximum clarity.

Due to its versatility and quality the Wiha **SYSTEM 4** is a reversible blade system that convinces every user.

Either for slotted, Phillips, TORX® or hex screws, the wide product range provides the right model for every application.

All reversible blades are made of high-quality CVM-steel, through hardened and chrome-plated, which provides an extra long service-life. The Wiha ChromTop® tips guarantee a perfect fit every time.

Just choose from the **SYSTEM 4** products for the relevant tool. Following handles are offered.

- The ergonomic **SoftFinish® telescopic handle**.
- The dissipative **SoftFinish® telescopic ESD handle**.

Each with adjustable blade lengths from 18 – 90 mm.

We offer **SYSTEM 4** sets in compact roll-up pouches, rigid metal and easy access plastic boxes.



Convincing variety and quality. **SYSTEM 4** – a real multi-tasker.

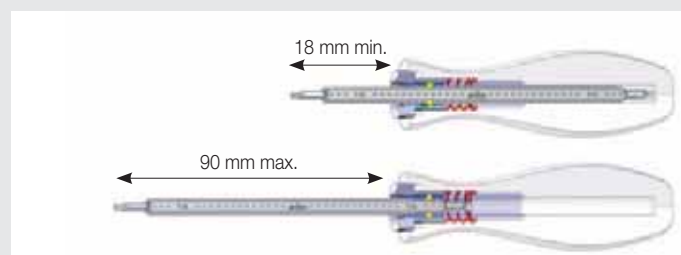

The **ClickStop** ball clamp in each telescopic handle allows 24 different visible blade lengths between 18 and 90 mm in 3 mm increments.



## Wiha **SYSTEM 4**.

- Versatile reversible precision blade system
- Sets in compact roll-up pouches, rigid metal- or easy access plastic-boxes
- Ergonomic handles for almost every application
- Colour-coded blades made of high-quality, tough chrome-vanadium-molybdenum steel, through hardened, chrome-plated
- Wiha ChromTop® tips ensure a perfect fit every time

**SYSTEM 4 handles.**



**2691** SYSTEM 4 SoftFinish®-telescopic handle.  
Ergonomic multi-component handle with roll-off protection.

Handle: With 4 mm hex retainer for all SYSTEM 4 blades.  
Enables adjustable blade lengths from 18 - 90 mm.  
ClickStop ball clamp guarantees a secure hold and rapid blade exchange.

Application: Ideal for all precision work in the fields of electronics and mechanics.

Order-No.	⌀	↔	⊕	⊖
30373	4.0	105	23	10



**2691ESD** SYSTEM 4 SoftFinish®-telescopic ESD handle.  
Dissipative handle, ESD-safe.

Handle: Ergonomic multi-component handle with roll-off protection.  
With 4 mm hex retainer for all SYSTEM 4 blades.  
Enables adjustable blade lengths from 18 - 90 mm.  
ClickStop ball clamp guarantees a secure hold and rapid blade exchange.  
Surface resistance 10<sup>6</sup> - 10<sup>9</sup> ohms.

Standards: IEC 61340-5-1.

Application: For working on electrostatically sensitive components.

Order-No.	⌀	↔	⊕	⊖
31498	4.0	105	23	10



**Safety Notice:**  
Wiha ESD screwdrivers are non-insulated, therefore not suitable for working on live parts.

**SYSTEM 4 reversible blades.**



**269** SYSTEM 4 slotted reversible blade.  
Blade: High quality chrome-vanadium-molybdenum steel, through hardened, chrome-plated.  
Colour-coded Wiha ChromTop® tips.

Order-No.	⌀	⌀	⊖	⊖	↔	⊕	⊖
00576	1.5	3.0	0.25	0.5	120	4.0	5
00577	2.0	3.5	0.4	0.6	120	4.0	5
00578	2.5	4.0	0.4	0.8	120	4.0	5



**269** SYSTEM 4 slotted Phillips reversible blade.  
Blade: High quality chrome-vanadium-molybdenum steel, through hardened, chrome-plated.  
Colour-coded Wiha ChromTop® tips.

Order-No.	⌀	⊕	⊖	↔	⊕	⊖
00601	2.0	PH00	0.4	120	4.0	5
00602	3.0	PH0	0.5	120	4.0	5
00603	4.0	PH1	0.8	120	4.0	5



**269** SYSTEM 4 Phillips reversible blade.  
Blade: High quality chrome-vanadium-molybdenum steel, through hardened, chrome-plated.  
Colour-coded Wiha ChromTop® tips.

Order-No.	⊕	⊕	↔	⊕	⊖
00579	PH000	PH00	120	4.0	5
00580	PH0	PH1	120	4.0	5



**269** SYSTEM 4 Pozidriv reversible blade.  
Blade: High quality chrome-vanadium-molybdenum steel, through hardened, chrome-plated.  
Colour-coded Wiha ChromTop® tips.

Order-No.	⊕	⊕	↔	⊕	⊖
03186	PZ0	PZ1	120	4.0	5

# Wiha SYSTEM 4.

Ideal for precision work.

## SYSTEM 4 reversible blades.



### 269 SYSTEM 4 TORX® reversible blade.

Blade: High quality chrome-vanadium-molybdenum steel, through hardened, chrome-plated.  
Colour-coded Wiha ChromTop® tips.

Order-No.					
26122	T1	T2	120	4.0	5
26123	T3	T4	120	4.0	5
26124	T5	T6	120	4.0	5
00597	T6	T8	120	4.0	5
00598	T7	T9	120	4.0	5
00599	T10	T15	120	4.0	5
00600	T15	T20	120	4.0	5



### 269 SYSTEM 4 combined ball end hex - hex reversible blade.

Blade: High quality chrome-vanadium-molybdenum steel, through hardened, chrome-plated.  
Colour-coded Wiha ChromTop® tips.

Extra: The ball end enables the user to work at angles up to 25°.

Order-No.					
00582	1.3	1.3	120	4.0	5
00583	1.5	1.5	120	4.0	5
00584	2	2	120	4.0	5
00585	2.5	2.5	120	4.0	5
00586	3	3	120	4.0	5
00587	4	4	120	4.0	5

## SYSTEM 4 reversible blades.



### 269 SYSTEM 4 nut driver.

For hex nuts.

Blade: High quality chrome-vanadium-molybdenum steel, through hardened, chrome-plated.

Application: For hex nuts.

Order-No.					
00588	1.5	1.8	125	4.0	5
00589	2	2.5	125	4.0	5
00590	3	-	125	4.0	5
00591	3.2	-	125	4.0	5
00592	3.5	-	125	4.0	5
00593	4	-	125	4.0	5
00594	4.5	-	125	4.0	5
00595	5	-	125	4.0	5
00596	5.5	-	125	4.0	5



### U759 00 SYSTEM 4 bit holder.

Suitable for C 4 (4 mm) bits.

Blade: Chrome-vanadium steel, through hardened, electro-plated.

Order-No.					
09195	4.0	135	4.0	9	1

## Wiha Info



Practical and compact:  
select the appropriate blade –  
insert it into the handle –  
that's all there is to it!

## SYSTEM 4 sets.

**269 T4** SYSTEM 4 reversible blades set, 4 pcs.  
Slotted/ Phillips.

- Blade: High quality chrome-vanadium-molybdenum steel, through hardened, chrome-plated.  
Colour-coded Wiha ChromTop® tips.  
Blade length is adjustable from 18 - 90 mm.
- Handle: SYSTEM 4 SoftFinish®-telescopic handle.  
ClickStop ball clamp guarantees a secure hold and rapid blade exchange.
- Extra: Robust roll-up pouches allows space-saving storage of tools.

Order-No.	Series	
00613	269 T4	10
	2691	SYSTEM 4 SoftFinish®-telescopic handle
① ⊕	269	2.0 - PH00 3.0 - PH0 4.0 - PH1

## SYSTEM 4 sets.

**269 T11** SYSTEM 4 reversible blades set, 11 pcs.  
Slotted/ Phillips/ hex/ ball end hex.

- Blade: High quality chrome-vanadium-molybdenum steel, through hardened, chrome-plated.  
Colour-coded Wiha ChromTop® tips.  
Blade length is adjustable from 18 - 90 mm.
- Handle: SYSTEM 4 SoftFinish®-telescopic handle.  
ClickStop ball clamp guarantees a secure hold and rapid blade exchange.
- Extra: Robust roll-up pouches allows space-saving storage of tools.

Order-No.	Series	
00610	269 T11	5
	2691	SYSTEM 4 SoftFinish®-telescopic handle
① ①	269	1.5 - 3.0 2.0 - 3.5 2.5 - 4.0
⊕ ⊕	269	PH000 - PH00 PH0 - PH1
⊙ ●	269	1.3 - 1.3 1.5 - 1.5 2 - 2 2.5 - 2.5
		3 - 3

**269 T6** SYSTEM 4 reversible blades set, 6 pcs.  
Slotted/ Phillips.

- Blade: High quality chrome-vanadium-molybdenum steel, through hardened, chrome-plated.  
Colour-coded Wiha ChromTop® tips.  
Blade length is adjustable from 18 - 90 mm.
- Handle: SYSTEM 4 SoftFinish®-telescopic handle.  
ClickStop ball clamp guarantees a secure hold and rapid blade exchange.
- Extra: Robust roll-up pouches allows space-saving storage of tools.

Order-No.	Series	
00616	269 T6	5
	2691	SYSTEM 4 SoftFinish®-telescopic handle
① ①	269	1.5 - 3.0 2.0 - 3.5 2.5 - 4.0
⊕ ⊕	269	PH000 - PH00 PH0 - PH1

**269 T6 01** SYSTEM 4 reversible blades set, 6 pcs.  
Phillips/ TORX®.

- Blade: High quality chrome-vanadium-molybdenum steel, through hardened, chrome-plated.  
Colour-coded Wiha ChromTop® tips.  
Blade length is adjustable from 18 - 90 mm.
- Handle: SYSTEM 4 SoftFinish®-telescopic handle.  
ClickStop ball clamp guarantees a secure hold and rapid blade exchange.
- Extra: Robust roll-up pouches allows space-saving storage of tools.

Order-No.	Series	
26121	269 T6 01	5
	2691	SYSTEM 4 SoftFinish®-telescopic handle
⊕ ⊕	269	PH000 - PH00 PH0 - PH1
⊙ ●	269	T3 - T4 T5 - T6 T8 - T10

# Wiha SYSTEM 4.

Ideal for precision work.

## SYSTEM 4 sets.



Telescopic

### 269 T11 01 SYSTEM 4 reversible blades set, 11 pcs. Slotted/ Phillips/ TORX®/ hex/ ball end hex.

**Blade:** High quality chrome-vanadium-molybdenum steel, through hardened, chrome-plated.  
Colour-coded Wiha ChromTop® tips.  
Blade length is adjustable from 18 - 90 mm.

**Handle:** SYSTEM 4 SoftFinish®-telescopic handle.  
ClickStop ball clamp guarantees a secure hold and rapid blade exchange.

**Extra:** Robust roll-up pouches allows space-saving storage of tools.

Order-No.	Series				
27820	269 T11 01				5
	2691	SYSTEM 4 SoftFinish®-telescopic handle			
① ①	269	1.5 - 3.0	2.0 - 3.5	2.5 - 4.0	
⊕ ⊕	269	PH000 - PH00 PH0 - PH1			
⊗ ⊗	269	T6 - T8	T7 - T9		
● ●	269	1.5 - 1.5	2 - 2	2.5 - 2.5	

## SYSTEM 4 sets in plastic boxes.



Telescopic

### 269 EB53 SYSTEM 4 reversible blades set, 5 pcs. Slotted/ Phillips.

**Blade:** High quality CVM steel, through hardened, chrome-plated.  
Colour-coded Wiha ChromTop® tips.  
Blade length is adjustable from 18 - 90 mm.

**Handle:** SYSTEM 4 SoftFinish®-telescopic handle.  
ClickStop ball clamp guarantees a secure hold and rapid blade exchange.

**Application:** Ideal for all precision work.

**Extra:** Delivery in a rigid, arrangeable plastic box.

Order-No.	Series				
32317	269 EB53				5
	2691	SYSTEM 4 SoftFinish®-telescopic handle			
① ①	269	1.5 - 3.0	2.0 - 3.5		
⊕ ⊕	269	PH000 - PH00 PH0 - PH1			

## Wiha Info



1 press

**Press sleeve:**  
=> Blade lock is released



2

18-90 mm

**Press and hold down sleeve:**  
=> Set desired blade length



3

**Release sleeve:**  
=> Blade is held securely



Telescopic

### 269 EB95 SYSTEM 4 reversible blades set, 9 pcs. Slotted/ Phillips/ TORX®.

**Blade:** High quality CVM steel, through hardened, chrome-plated.  
Colour-coded Wiha ChromTop® tips.  
Blade length is adjustable from 18 - 90 mm.

**Handle:** SYSTEM 4 SoftFinish®-telescopic handle.  
ClickStop ball clamp guarantees a secure hold and rapid blade exchange.

**Application:** Ideal for all precision work.

**Extra:** Delivery in a rigid, arrangeable plastic box.

Order-No.	Series				
32316	269 EB95				5
	2691	SYSTEM 4 SoftFinish®-telescopic handle			
① ①	269	1.5 - 3.0	2.0 - 3.5	2.5 - 4.0	
⊕ ⊕	269	PH000 - PH00 PH0 - PH1			
⊗ ⊗	269	T6 - T8	T7 - T9	T10 - T15	





**Safety Notice:**

Wiha ESD screwdrivers are non-insulated, therefore not suitable for working on live parts.

**SYSTEM 4 display and ESD set.**



Telescopic



**269 VB1** SYSTEM 4 display.  
Acryl glass display with 85 pieces.

Order-No.	Series				
00620	269 VB1				
	2691	4xSYSTEM 4 SoftFinish®-telescopic handle			
⓪	⓪ 269	4x4.0			
⓪	⓪ 269	7x1.5	7x2.0		
⊕	⊕ 269	7xPH000	7xPH0		
⊗	⊗ 269	7x1.5	7x2	7x2.5	7x3
⊛	⊛ 269	7xT6	7xT7	7xT10	



Telescopic



**2691 T11 ESD** SYSTEM 4 ESD reversible blades set, 11 pcs.  
Slotted/ Phillips/ TORX®/ hex/ ball end hex.

Blade: High quality chrome-vanadium-molybdenum steel, through hardened, chrome-plated.  
Colour-coded Wiha ChromTop® tips.  
Blade length is adjustable from 18 - 90 mm.

Handle: SYSTEM 4 SoftFinish®-telescopic ESD handle.  
ESD-safe (dissipative), surface resistance 10<sup>6</sup> - 10<sup>9</sup> ohms.  
ClickStop ball clamp guarantees a secure hold and rapid blade exchange.

Extra: In a roll-up pouch made of ESD-safe material.

Order-No.	Series				
31499	2691 T11 ESD	5			
	2691 ESD	SYSTEM 4 SoftFinish®-telescopic ESD handle			
⓪	⓪ 269	1.5 - 3.0	2.0 - 3.5	2.5 - 4.0	
⊕	⊕ 269	PH000 - PH00 PH0 - PH1			
⊗	⊗ 269	T6 - T8	T7 - T9		
⊛	⊛ 269	1.5 - 1.5	2 - 2	2.5 - 2.5	

**SYSTEM 4 ESD sets.**



Telescopic



**7000 EB16 ESD** SYSTEM 4 ESD bit set, 16 pcs.  
Mixed sets.

Handle: SYSTEM 4 SoftFinish®-telescopic ESD handle.  
ESD-safe (dissipative), surface resistance 10<sup>6</sup> - 10<sup>9</sup> ohms.  
Enables adjustable bit holder blade length.

Standards: DIN 3126, ISO 1173, style C 4.  
IEC 61340-5-1.

Case: No danger to electronic components with use of ESD-safe materials.  
Tough, space-saving metal box.

Application: Bit set suitable for smallest screws with electronic components.  
Flexible working via adjustable blade length and rapid replacement of bit inserts.

Order-No.	Series				
33503	7000 EB16 ESD	1			
	2691 ESD	1xSYSTEM 4 SoftFinish®-telescopic ESD handle			
	U759 00	1xSYSTEM 4 bit holder			
⓪	U750	1x2.0	1x3.0		
⊕	U751	1xPH000	1xPH00	1xPH0	1xPH1
⊗	U757	1xT3	1xT4	1xT5	1xT6
		1xT8			
⊛	U753	1x0.9	1x1.3	1x1.5	



Telescopic













**7000 EB26 ESD** SYSTEM 4 ESD bit set, 26 pcs.  
Mixed sets.

Order-No.	Series				
33848	7000 EB26 ESD	1			
	2691 ESD	1xSYSTEM 4 SoftFinish®-telescopic ESD handle			
	U759 00	1xSYSTEM 4 bit holder			
⓪	U750	1x1.5	1x2.0	1x3.0	1x4.0
⊕	U751	1xPH000	1xPH00	1xPH0	1xPH1
⊗	U757	1xT3	1xT4	1xT5	1xT6
		1xT7	1xT8	1xT9	1xT10
⊛	U753	1x0.7	1x0.9	1x1.3	1x1.5
		1x2.0	1x2.5	1x3.0	1x4.0

# Wiha L-keys.

Wiha makes it possible: Perfect technic for professional work.



	 Slotted	 Phillips PH	 Pozidriv PZ	 TORX®	 TORX® Tamper Resistant	 TORX PLUS®	 Hex (mm, inch)	 Nut Driver (mm, inch)	 Square nut	 Hex with pivot	 Multi-tooth	
L-keys				149-157	157	151, 157	131-147			145	156	
ErgoStar holder				149, 153		131, 133, 135						
ProStar holder				150, 153-155			134-138, 140-141					
Compact holder							139, 141-144	146-147				
Classic holder				150/153, 155-156	157	151, 157	136, 139-147					
PocketStar holder	160-162	160-162		160-162	161		159-162					
ComfortGrip T-handle				165			164-165					
Classic T-handle				170		170	167-169	168-169	168			
Flag handle				172		172	172					
Key handle				173		173						
Offset screwdriver	173	173	173									

## L-key range

### Wiha product range overview / holder overview

All Wiha L-key holders at a glance ..... 126 – 127



### Wiha product advantages (specialised solutions)

All Wiha product advantages at a glance ..... 128 – 129



### Wiha ErgoStar

He's fastening on to something good ..... 130 – 131

- Ballend hex keys. Metric sizes ..... 132 – 133
- Ballend hex keys with MagicRing. Imperial sizes ..... 135
- TORX® MagicSpring® ..... 149
- TORX® ball ..... 152 – 153



### Wiha L-keys

- Hex keys with MagicRing. Metric sizes ..... 132 – 134
- Ballend hex keys, colour coded. Metric sizes ..... 136
- Ballend hex key. Metric sizes ..... 137 – 141
- Hex keys. Metric sizes ..... 141 – 145
- Ballend hex keys with MagicRing. Imperial sizes ..... 135
- Ballend hex keys. Imperial sizes ..... 146
- Hex keys. Imperial sizes ..... 147
- TORX® MagicSpring® ..... 148 – 151
- TORX® ball ..... 152 – 153
- TORX® titanium silver ..... 154
- TORX® ..... 155 – 156
- TORX® Tamper Resistant ..... 157
- TORX PLUS® ..... 157



### Wiha PocketStar / Mini PocketStar

Press one button for the correct key ..... 158 / 162

- Ballend hex keys with MagicRing. Metric sizes ..... 159
- Hex keys. Metric sizes ..... 159
- TORX® ..... 160
- TORX® Tamper Resistant ..... 161
- Mixed ..... 160 / 162

### Wiha ComfortGrip / Classic T-handle

Hex keys with MagicRing. Metric sizes ..... 163 / 166

- Ballend hex keys. Metric sizes ..... 164 / 167
- Hex keys. Metric sizes ..... 164 / 168
- Hex keys. Imperial sizes ..... 169
- TORX® MagicSpring ..... 170
- TORX PLUS® ..... 170
- TORX® ..... 165 / 170



### Wiha flag and key handle

Hex keys. Metric sizes ..... 171

- TORX® ..... 172
- TORX PLUS® ..... 172 – 173



























### Wiha Offset screwdriver

- Slotted ..... 173
- Phillips ..... 173
- Pozidriv ..... 173



# Wiha product range overview / holder overview

All Wiha L-key holders at a glance

Holders	ErgoStar holder	ProStar holder	Compact holder	Classic holder
				
Holder type	Two-row holder	Two-row holder	Two-row holder	Single-row holder
Description	Wiha ErgoStar: this holder stands for comfortable and fast handling. Mechanical operation in form of rotating enables simple and rapid access to each key without being hindered by the other keys.	Wiha ProStar: this holder stands for simple operation. A sliding function enables removing each individual key without accessing the other keys.	Wiha Compact: this holder stands for a combination of space-saving storage and ideal key fixing	Wiha Classic: this holder stands for quick operation. Short removal distances of the keys achieve time-saving operation.
Features	<ul style="list-style-type: none"> <li>• Simultaneous operation of all keys</li> <li>• Easy and quick key removal</li> <li>• Solid stopping point for fixing L-keys in the holder</li> <li>• Innovative clamping ensures L-keys are held firmly in both closed and open state</li> <li>• Compact design takes up little space on the bench or in the toolbox</li> <li>• Wall bracket for practical storage of the ErgoStar</li> <li>• Colour guidance system for output recognition</li> </ul>	<ul style="list-style-type: none"> <li>• Sliding function for one-handed opening of the holder</li> <li>• Easy and quick removal</li> <li>• Compact design takes up little space on the bench or in the toolbox</li> <li>• Hanging possible using hanging bracket</li> <li>• Colour guidance system for output recognition</li> </ul>	<ul style="list-style-type: none"> <li>• Innovative clamping ensures L-keys are held firmly in the holder</li> <li>• Very compact holder construction saves room on workbenches and in toolboxes</li> <li>• Colour guidance system for output recognition</li> </ul>	<ul style="list-style-type: none"> <li>• Easy and very quick key removal</li> <li>• Innovative clamping ensures L-keys are held firmly in the holder</li> <li>• Solid stopping point for fixing L-keys in the holder</li> <li>• Very flat holder construction saves room on workbenches and in toolboxes</li> <li>• Hanging possible using hanging bracket</li> <li>• Colour guidance system for output recognition</li> </ul>
Surfaces	ErgoStar holder	ProStar holder	Compact holder	Classic holder
<b>A</b> = brilliant chrome-plated <b>B</b> = matt chrome-plated <b>C</b> = titanium silver-plated <b>D</b> = nickel-plated <b>E</b> = black finish				
Profile on page	ErgoStar holder	ProStar holder	Compact holder	Classic holder
Hexagon metric 	 131-133	 134, 136-138 140-141	 139; 141-144	 136; 139-145
Hexagon inch 	 135	 135; 146-147		 146-147
TORX® 	 149; 153	 150; 153-155		 150; 153; 155-156
TORX PLUS® 				 151; 157
TORX® TR 				 157
Hex with pivot 				
Multitooth 				



Roll-up bag	Box	Key ring	Workbench stand
-------------	-----	----------	-----------------



Roll-up bag	Box	Key ring	Workbench stand
Bag for variable equipping.	A practical sliding box for the Wiha L-keys is available to protect against the impact of dirt.		The perfect solution for daily access at the workbench.
<ul style="list-style-type: none"> <li>• Variable equipping</li> </ul>	<ul style="list-style-type: none"> <li>• Protection against the impact of dirt</li> <li>• Hanging possible using hanging bracket</li> <li>• Colour guidance system for output recognition</li> </ul>	<ul style="list-style-type: none"> <li>• Hanging possible using hanging bracket</li> </ul>	<ul style="list-style-type: none"> <li>• Hanging possible using hanging bracket on the back</li> </ul>

Roll-up bag	Box	Key ring	Workbench stand
-------------	-----	----------	-----------------























Roll-up bag	Box	Key ring	Workbench stand
	139; 142; 144	144	144
			156
145			
156			





# Wiha product advantages (specialised solutions)

All Wiha product advantages at a glance

Holders	Logo	Application images	Description		
<b>Ball end</b>			The Wiha ball end stands for mobility, thus enabling fastening of allen screws up to 30° per side.		
<b>Ball end TORX®</b>			The Wiha ball end stands for mobility, thus enabling fastening of TORX® screws up to 25° per side.		
<b>MagicRing®</b>			Wiha L-keys with Magic-Ring® hold allen screws firmly in any position thanks to a high-tensile spring steel ring.		
<b>MagicSpring®</b>			Wiha L-keys with Magic-Ring® hold TORX® and TORX PLUS® screws firmly in any position thanks to a high-tensile spring steel ring.		
<b>Stubby</b>			The new L-key from Wiha, especially for hard-to-reach screws and confined spaces.		
<b>Colour coding</b>					
	 <b>Red</b>	 <b>Yellow</b>	 <b>Green</b>	The Wiha colour guidance system identifies the output category. There is a distinction among the categories Hexagon metric, Hexagon inch, TORX® and TORX PLUS®.	
	Hexagon metric	Hexagon inch	TORX®		TORX PLUS®
					
					

### Advantages

- Fastenings at angles up to 30° per side
  - Quick feeding of the key into the screw thanks to feeding from various angles
  - The key does not slip out of the screw, which reduces the risk of accidents
  - No deformation of the screw head thanks to precision fitting of the ball end
- Fastenings at angles up to 25° per side
  - Higher torque transmission due to maximum core diameter
  - Elongated profile positioning for further use of the L-key
- Thanks to the combination of MagicRing® with the Wiha ball end, inserting and removing screws is possible, even in hard-to-reach locations
  - Securely holds screws made of steel and non-magnetic materials such as stainless steel, titanium, aluminium and plastics in any position
  - Can be used for all standard screws
  - Use for applications in which magnetised fastening tools cannot and may not be used (magnetic environment)!
  - Fastenings at angles up to 25° per side
- Securely holds screws made of steel and non-magnetic materials such as stainless steel, titanium, aluminium and plastics in any position
  - TORX® and TORX PLUS® screws manufactured according to Camcar Textron specifications
  - Use for applications in which magnetised fastening tools cannot and may not be used (magnetic environment)!
- Reduction of the short L-key arm, especially for hard-to-reach screws and confined spaces
  - Increase in the hand working space of over 30% and thus a reduction of the risk of injury to the knuckles and fingertips thanks to a 95° bend of the L-key
  - Improved access through a reduction of the L-key head height of up to 15%
  - Ball end geometry enables fastening at an angle of up to 25°
- Handles and holders in the same colour depending on the output size
  - This provides an overview of the tool assortment



# Wiha ErgoStar.

Fastening on to something good.



reddot design award  
winner 2010



Focus Open  
Silber 2011



Extremely agile: the new ball end now enables fastenings up to an angle of 30°.



The trick with the new Wiha ErgoStar is as simple as it is effective: rotating a single L-key in the holder means that all other keys rotate to the side at the same angle! That means: there's no more complicated disentangling of adjacent keys any more. All L-keys are ready for removal with a single turn, quicker, more simply and more clearly than ever before.

But easy removal is not the only advantage. The set of Wiha premium L-keys from the series 369S is also included. With the new ball end design, screws can be effortlessly fastened even at an angle up to 30°. Through-hardened, chrome vanadium steel and high quality brilliant chroming are further convincing reasons that make the L-keys essential accessories for everyday work.



The right idea: a flowing movement means all L-keys are ready for removal.



Wall holder for practical storage of the Wiha ErgoStar: all keys always ready to hand. Available together with the Wiha ErgoStar in all display and blister pack versions.



## Wiha ErgoStar.

- Innovative key extraction: One turn and all L-keys are rapidly and conveniently ready for removal
- Quick replacement of keys in the holder thanks to a solid stopping point
- Guaranteed firm fixing of keys over the complete life service
- Up to 25% more corrosion resistance thanks to high quality brilliant chroming
- Metric scale (SW 10) in range 20 – 150 mm

**For Allen screws (metric).**



**369S Ball end hex L-key, long.**

Blade: Chrome vanadium steel, through-hardened, brilliant chrome-plated.  
 Standards: Based on ISO 2936L.  
 Application: Especially for screws that are difficult to access.  
 Extra: The ball end enables fastening and unfastening at an angle of up to 30°.

Order-No.	●	↔	↱	↲
34755	1.5	91	15	10
34756	2	101	18	10
34757	2.5	113	20	10
34758	3	128	23	10
34759	4	142	29	10
34760	5	163	33	10
34761	6	184	38	10
34762	8	206	44	10
34763	10	231	50	5 With mm scale



**369 H9S Hexagon ball end L-key set in ErgoStar holder. Brilliant chrome-plated, 9 pcs.**

Blade: Chrome vanadium steel, through-hardened, brilliant chrome-plated.  
 Standards: Based on ISO 2936L.  
 Application: Especially for screws that are difficult to access.  
 Extra: Mechanical operation of the space-saving ErgoStar holder makes simplest removal of each individual L-key possible without movement of the others.  
 The ball end enables fastening and unfastening at an angle of up to 30°. Metric scale permanently lasered on to the (SW 10) key for depth, inner, outer and step measurements between 20 to 150 mm.

Order-No.	Series	↲
34753	369 H9S	5
	● 369S	
		1.5 2 2.5 3 4
		5 6 8 10

**SB 369 H9S Hexagon ball end L-key set in ErgoStar holder. Brilliant chrome-plated, 9 pcs. Blister packed. With practical wall bracket.**

Order-No.	Series	↲
34754	SB 369 H9S	5
	● 369S	
		1.5 2 2.5 3 4
		5 6 8 10

**Wall bracket. Display.**



**NEW 6874 ErgoStar wall holder.**

For all common ErgoStar L-key holders.  
 Wall bracket for practical and fast storage.

Order-No.	↲
39205	5



**NEW 34764 Display hexagon ball end L-key sets in ErgoStar holder. Brilliant chrome-plated, 9 pcs. Card display with 5 pieces.**

Order-No.	Content	●	↲
34764	5 x 369 H9S	1.5 - 10	1



# Wiha MagicRing® hexagon L-key.

Securely holds hexagon bolts in place in any position.

*MagicRing® holds all standard screws!*

- DIN 6912
- DIN 7984
- DIN EN ISO 4762
- DIN EN ISO 10642
- DIN EN ISO 4026
- DIN EN ISO 4027
- DIN EN ISO 4028
- DIN EN ISO 4029
- DIN EN ISO 7380



Wiha hex keys with MagicRing® guarantee the perfect location of hex screws in every position.

Due to a high-quality retaining ring in the key head, the insertion of a screw in straight, inclined or very deep pocket holes is no problem. The new ball geometry with MagicRing® now offers even more advantages:

- Greater retention force for screws. For example, size 6 holds screws up to 1000 mm in length.
- Enlarged maximum torque of up to 10% due to the new ball geometry.
- Can now be used with all standard screws.

A further advantage is that the Wiha MagicRing® can even be used to hold non-magnetisable screws made of stainless steel, titanium and aluminium.



Wiha MagicRing® metric is only available as long design from size 3. With the inch dimensions, MagicRing® is available from 1/8". All series are made from high-quality chrome-vanadium steel.

*Thanks to the Wiha MagicRing®, inserting and removing screws is safe and easy, even in areas that are difficult to access.*



*The ball end can be rotated by up to 25° in both clockwise and anti-clockwise direction.*



**Wiha MagicRing® hexagon L-key.**

- Suitable for removing sunk-head standard screws and for inserting and working screws in horizontal, inclined or deep pocket holes
- Holds screws made of steel and non-magnetisable materials such as stainless steel, titanium and aluminium
- Ideal for applications where there is insufficient space for a simple hex key
- No troublesome searching for dropped screws



## For Allen screws (metric).

**369R** Ball end hex L-key, long.  
With MagicRing®.

Blade: Chrome-vanadium steel, through hardened, chrome-plated.  
Standards: Based on ISO 2936L.  
Application: Insert screws into or remove from boreholes, especially in difficult to access areas.  
Extra: MagicRing® of spring steel (from size 3 mm) secures all hex standard screws independently of screw material in any position. The ball end enables the user to work at angles up to 25°.

Order-No.	●	↔	↙ ↘	↗ ↘
20549	3	128	23	10
20550	4	142	29	10
20570	5	163	33	10
20551	6	184	38	10
20552	8	206	44	10
20553	10	231	50	5

## For Allen screws (metric).

**NEW****369R H9** Hexagon ball end L-key set in ErgoStar holder.  
With MagicRing®, chrome-plated, 9 pcs.

Blade: Chrome-vanadium steel, through hardened, chrome-plated.  
Standards: Based on ISO 2936L.  
Application: Insert screws into or remove from boreholes, especially in difficult to access areas.  
Extra: Mechanical operation of the space-saving ErgoStar holder makes simplest removal of each individual L-key possible without movement of the others. MagicRing® of spring steel (from size 3 mm) secures all hex standard screws independently of screw material in any position. The ball end enables the user to work at angles up to 25°.

Order-No.	Series							↗ ↘
37351	369R H9							5
●	369	1.5	2	2.5				
●	369R	3	4	5	6	8	10	

**NEW****SB 369R H9** Hexagon ball end L-key set in ErgoStar holder.  
With MagicRing®, chrome-plated, 9 pcs.  
Blister packed  
With practical wall bracket.

Order-No.	Series							↗ ↘
37352	SB 369R H9							5
●	369	1.5	2	2.5				
●	369R	3	4	5	6	8	10	



## Wiha Info

**Wiha MagicRing®.**

Thanks to the Wiha MagicRing®, inserting and removing screws is safe and easy, even in areas that are difficult to access.

# Wiha MagicRing® hexagon L-key.

Securely holds hexagon bolts in place in any position.

For Allen screws (metric).

Displays.



**369R S9** Ball end hex L-key set in ProStar.  
With MagicRing®, chrome-plated, 9 pcs.

Blade: Chrome-vanadium steel, through hardened, chrome-plated.  
Standards: Based on ISO 2936L.  
Application: Insert screws into or remove from boreholes, especially in difficult to access areas.  
Extra: Space saving ProStar allows the easy removal of each key without moving any others.  
MagicRing® of spring steel (from size 3 mm) secures all hex standard screws independently of screw material in any position.  
The ball end enables the user to work at angles up to 25°.



**369R SVH1** Display ball end hex L-key sets.  
With MagicRing®, chrome-plated, in ProStar holder, 9 pcs.  
Carton display with 10 pieces.

Order-No.	Content		
23265	10 x 369R S9	1.5 - 10	1

Order-No.	Series								
20709	369R S9								5
	● 369	1.5	2	2.5					
	● 369R	3	4	5	6	8	10		

**SB 369R S9** Ball end hex L-key set in ProStar.  
With MagicRing®, chrome-plated, 9 pcs.  
Blister packed.



**369R SVH2** Display ball end hex L-key sets.  
With MagicRing®, chrome-plated, in ProStar holder, 9 pcs.  
Card display with 4 pieces + test card.

Order-No.	Content		
36130	4 x 369R S9 + test card	1.5 - 10	1

**For Allen screws (inch).**



**369R Zoll** Ball end hex L-key, long. With MagicRing®. Inch sizes.

Blade: Chrome-vanadium steel, through hardened, chrome-plated.  
 Standards: Based on ASME B18.3.  
 Application: Insert hex inch screws into and remove from boreholes, especially in difficult to access areas.  
 Extra: MagicRing® made from spring steel holds all standard screws tight at various angles (available from 1/8"). The ball end enables the user to work at angles up to 25°.

Order-No.	Series	mm	mm	mm	mm	mm	mm	mm	mm
29471	0.05	72	13	1.27					10
29472	1/16	80	15	1.59					10
29474	5/64	88	18	1.98					10
29473	3/32	101	20	2.38					10
29475	7/64	111	21	2.78					10
24302	1/8	121	23	3.17	MagicRing®				10
24304	9/64	136	27	3.57	MagicRing®				10
24303	5/32	148	29	3.96	MagicRing®				10
24305	3/16	163	33	4.76	MagicRing®				10
24306	7/32	176	36	5.55	MagicRing®				10
24307	1/4	191	38	6.35	MagicRing®				10
24308	5/16	210	43	7.93	MagicRing®				10
24341	3/8	232	49	9.52	MagicRing®				10

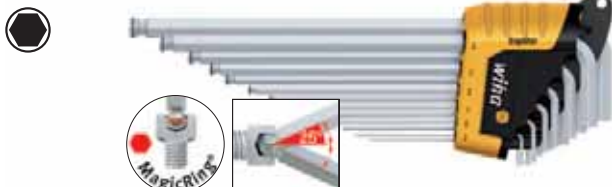

**369R HZ13** Hexagon ball end L-key set in ErgoStar holder. From size 1/8" with MagicRing®, chrome-plated, 13 pc. inch design.

Blade: Chrome-vanadium steel, through hardened, chrome-plated.  
 Standards: Based on ASME B18.3.  
 Application: Insert hex inch screws into and remove from boreholes, especially in difficult to access areas.  
 Extra: Mechanical operation of the space-saving ErgoStar holder makes simplest removal of each individual L-key possible without movement of the others. MagicRing® made from spring steel holds all standard screws tight at various angles (available from 1/8"). The ball end enables the user to work at angles up to 25°.

Order-No.	Series	mm	mm	mm	mm	mm	mm	mm	mm
36521	369R HZ13								5
	● 369 Zoll C	0.05	1/16	5/64	3/32	7/64			
	● 369R Zoll	1/8	9/64	5/32	3/16	7/32	1/4	5/16	3/8

**SB 369R HZ13** Hexagon ball end L-key set in ErgoStar holder. From size 1/8" with MagicRing®, chrome-plated, 13 pc. inch design. Blister packed. With practical wall bracket.

Order-No.	Series	mm
36522	SB 369R HZ13	5

**For Allen screws (inch).**



**369R SZ13** Ball end hex L-key set in ProStar. With MagicRing®, chrome-plated, 13 pcs. Inch sizes.

Blade: Chrome-vanadium steel, through hardened, chrome-plated.  
 Standards: Based on ASME B18.3.  
 Application: Insert hex inch screws into and remove from boreholes, especially in difficult to access areas.  
 Extra: Space saving ProStar allows the easy removal of each key without moving any others. MagicRing® made from spring steel holds all standard screws tight at various angles (available from 1/8"). The ball end enables the user to work at angles up to 25°.

Order-No.	Series	mm
24190	369R SZ13	5
	● 369 Zoll C	0.05 1/16 5/64 3/32 7/64
	● 369R Zoll	1/8 9/64 5/32 3/16 7/32 1/4 5/16 3/8

**SB 369R SZ13** Ball end hex L-key set in ProStar. With MagicRing®, chrome-plated, 13 pcs. Inch sizes. Blister packed.

Order-No.	Series	mm
24850	SB 369R SZ13	5



**Wiha Info**



**Wiha ErgoStar**  
 The right idea: a flowing movement means all L-keys are ready for removal.



# Wiha hexagon L-key (metric).

## For Allen screws (metric).



### 369F Ball end hex L-key, long.

Blade: Chrome vanadium steel, through-hardened, colour-coded.  
 Standards: Based on ISO 2936L.  
 Application: Especially for screws that are difficult to access.  
 Extra: The ball end enables the user to work at angles up to 25°. Colour coding for immediate identification of L-keys.

Order-No.	●	↔	↙	◀C	▬
34269	1.5	91	15	black	10
34270	2	101	18	green	10
34271	2.5	113	20	turquoise	10
34272	3	128	23	light blue	10
34273	4	142	29	purple	10
34274	5	163	33	red	10
34275	6	184	38	orange	10
34276	8	206	44	yellow	10
34277	10	231	50	grey	5

## For Allen screws (metric).



### 369T Ball end hex L-key, long.

Blade: Chrome-vanadium steel, through hardened, chrome-plated.  
 Standards: Based on ISO 2936L.  
 Application: Specially for hard-to-reach screws and confined spaces.  
 Extra: Increase in the hand working space of over 30% and thus a reduction of risk of injury to the knuckles and fingertips thanks to 95° bend of the L-key. Improved access through a reduction of the L-key head height of up to 15%.  
 The ball end enables the user to work at angles up to 25°.

Order-No.	●	↔	↙	▬
35482	1.5	91	5.5	10
35483	2	101	9	10
35484	2.5	113	9.5	10
35485	3	128	11	10
35486	4	142	13	10
35487	5	163	15	10
35488	6	184	18	10
35489	8	206	22	10
35490	10	231	28	5



### 369 H9F Hexagon ball end L-key set in Classic holder.

Blade: Chrome vanadium steel, through-hardened, colour-coded.  
 Standards: Based on ISO 2936L.  
 Application: Especially for screws that are difficult to access.  
 Extra: Popular key sizes kept in a well-organised holder. Simple, rapid operation with solid stopping point for L-keys. The ball end enables the user to work at angles up to 25°. Colour coding for immediate identification of L-keys.

Order-No.	Series	▬
34268	369 H9F	5
● 369F	1.5 2 2.5 3 4 5 6 8 10	

### SB 369 H9F Hexagon ball end L-key set in Classic holder. Blister packed.

Order-No.	Series	▬
35683	SB 369 H9F	10
● 369F	1.5 2 2.5 3 4 6 8 10	



### 369T S9 Ball end hex L-key set in ProStar. Chrome-plated, 9 pcs.

Blade: Chrome-vanadium steel, through hardened, chrome-plated.  
 Standards: Based on ISO 2936L.  
 Application: Specially for hard-to-reach screws and confined spaces.  
 Extra: Space saving ProStar allows the easy removal of each key without moving any others. Increase in the hand working space of over 30% and thus a reduction of risk of injury to the knuckles and fingertips thanks to 95° bend of the L-key. Improved access through a reduction of the L-key head height of up to 15%.  
 The ball end enables the user to work at angles up to 25°.

Order-No.	Series	▬
35480	369T S9	5
● 369T	1.5 2 2.5 3 4 5 6 8 10	

### SB 369T S9 Ball end hex L-key set in ProStar. Chrome-plated, 9 pcs. Blister packed.

Order-No.	Series	▬
35481	SB 369T S9	5
● 369T	1.5 2 2.5 3 4 5 6 8 10	

## For Allen screws (metric).

**369** Ball end hex L-key, long.

Blade: Chrome-vanadium steel, through hardened, chrome-plated.  
 Standards: Based on ISO 2936L.  
 Application: Especially for screws that are difficult to access.  
 Extra: The ball end enables the user to work at angles up to 25°.

Order-No.	●	↔	∠	⊞
01392	1.5	91	15	10
01393	2	101	18	10
01395	2.5	113	20	10
01396	3	128	23	10
01398	4	142	29	10
01400	5	163	33	10
01402	6	184	38	10
07922	7	195	39	5
01404	8	206	44	10
36452	9	217	47	5
01406	10	231	50	5
01408	12	259	57	5

**SB 369** Ball end hex L-key, long.  
Blister packed.

Order-No.	●	↔	∠	⊞
08161	1.5	91	15	10
08162	2	101	18	10
08163	2.5	113	20	10
08164	3	128	23	10
08165	4	142	29	10
08166	5	163	33	10
08167	6	184	38	10
08168	8	206	44	5
08169	10	231	50	5
08170	12	259	57	5

## For Allen screws (metric).

**369 S9** Ball end hex L-key set in ProStar.  
Chrome-plated, 9 pcs.

Blade: Chrome-vanadium steel, through hardened, chrome-plated.  
 Standards: Based on ISO 2936L.  
 Application: Especially for screws that are difficult to access.  
 Extra: Space saving ProStar allows the easy removal of each key without moving any others.  
 The ball end enables the user to work at angles up to 25°.

Order-No.	Series	⊞
07185	369 S9	5
● 369	1.5 2 2.5 3 4	
	5 6 8 10	

**SB 369 S9** Ball end hex L-key set in ProStar.  
Chrome-plated, 9 pcs.  
Blister packed.

Order-No.	Series	⊞
07192	SB 369 S9	5
● 369	1.5 2 2.5 3 4	
	5 6 8 10	



# Wiha hexagon L-key (metric).

## Displays.



**369 SVH1** Display ball end hex L-key sets.  
Chrome-plated, in ProStar holder, 9 pcs.  
Card display with 10 pieces.

Order-No.	Content	●	☰
07194	10 x 369 S9	1.5 - 10	1

## Display.



**NEW**  
**369 VH1** Hexagon ball end L-key set display, long.  
Chrome-plated.  
Acryl glass display with 102 pieces.

Order-No.	Series	☰
36131	369 VH1	1
	● 369	
	11x1.5	11x2
	11x3	11x4
	11x6	11x8
		11x2.5
		11x5
		7x10
		7x12



**369 SVH2** Display ball end hex L-key sets.  
Chrome-plated, in ProStar holder, 9 pcs.  
Card display with 5 pieces.

Order-No.	Content	●	☰
36129	5 x 369 S9	1.5 - 10	1

## For Allen screws (metric).

**369 H11** Hexagon ball end L-key set in Compact holder.  
Chrome-plated, 11 pcs.

Blade: Chrome-vanadium steel, through hardened, chrome-plated.  
Standards: Based on ISO 2936L.  
Application: Especially for screws that are difficult to access.  
Extra: Thanks to its compact form the Wiha Compact holder fits perfectly into any folding rule pocket.  
The ball end enables the user to work at angles up to 25°.  
Including SW 7 and SW 9 special sizes.

Order-No.	Series											
36453	369 H11	5										
	● 369	1.5	2	2.5	3	4					5	
		5	6	7	8	9	10					

**SB 369 H11** Hexagon ball end L-key set in Compact holder.  
Chrome-plated, 11 pcs.  
Blister packed.

Order-No.	Series											
36454	SB 369 H11	5										
	● 369	1.5	2	2.5	3	4					5	
		5	6	7	8	9	10					

**369 H9** Hexagon ball end L-key set in Compact holder.  
Chrome-plated, 9 pcs.

Blade: Chrome-vanadium steel, through hardened, chrome-plated.  
Standards: Based on ISO 2936L.  
Application: Especially for screws that are difficult to access.  
Extra: Thanks to its compact dimensions, this holder fits easily into every ruler pocket.  
Popular key sizes kept in a well-organised holder.  
The ball end enables the user to work at angles up to 25°.

Order-No.	Series										
01418	369 H9	5									
	● 369	1.5	2	2.5	3	4					5
		5	6	8	10						

**SB 369 H9** Hexagon ball end L-key set in Compact holder.  
Chrome-plated, 9 pcs.  
Blister packed.

Order-No.	Series										
02292	SB 369 H9	5									
	● 369	1.5	2	2.5	3	4					5
		5	6	8	10						

## For Allen screws (metric).

**369 H7** Hexagon ball end L-key set in Classic holder.  
Chrome-plated, 7 pcs.

Blade: Chrome-vanadium steel, through hardened, chrome-plated.  
Standards: Based on ISO 2936L.  
Application: Especially for screws that are difficult to access.  
Extra: Popular key sizes kept in a well-organised holder.  
Simple, rapid operation with solid stopping point for L-keys.  
The ball end enables the user to work at angles up to 25°.

Order-No.	Series										
01416	369 H7	5									
	● 369	1.5	2	2.5	3	4	5	6			

**SB 369 H7** Hexagon ball end L-key set in Classic holder.  
Chrome-plated, 7 pcs.  
Blister packed.

Order-No.	Series										
03723	SB 369 H7	10									
	● 369	1.5	2	2.5	3	4	5	6			

**369 B8** Ball end hex L-key set in sliding box.  
Chrome-plated, 8 pcs.

Blade: Chrome-vanadium steel, through hardened, chrome-plated.  
Standards: Based on ISO 2936L.  
Application: Especially for screws that are difficult to access.  
Extra: Large, impact resistant sliding box.  
The ball end enables the user to work at angles up to 25°.

Order-No.	Series										
01410	369 B8	5									
	● 369	2	2.5	3	4	5	6	8	10		

# Wiha hexagon L-key (metric).

## For Allen screws (metric).



### 369B Ball end hex L-key, long.

Blade: Chrome-vanadium steel, through-hardened, black finish.  
 Standards: Based on ISO 2936L.  
 Application: Especially for screws that are difficult to access.  
 Extra: The ball end enables the user to work at angles up to 25°.

Order-No.	●	↔	↙	↘
01391	1.3	74	14	10
05638	1.5	91	15	10
03868	2	101	18	10
03869	2.5	113	20	10
03870	3	128	23	10
03871	4	142	29	10
03872	5	163	33	10
03873	6	184	38	10
03874	8	206	44	10
03875	10	231	50	5
03876	12	259	57	5

## For Allen screws (metric).



### 369 SVH1B Display ball end hex L-key sets. Black finish, in ProStar, 9 pcs. Carton display with 10 pieces.

Order-No.	Content	●	↔
07195	10 x 369 S9B	1.5 - 10	1



### 369 S9B Ball end hex L-key set in ProStar. Black finish, 9 pcs.

Blade: Chrome-vanadium steel, through-hardened, black finish.  
 Standards: Based on ISO 2936L.  
 Application: Especially for screws that are difficult to access.  
 Extra: Space saving ProStar allows the easy removal of each key without moving any others.  
 The ball end enables the user to work at angles up to 25°.

Order-No.	Series	↔
07186	369 S9B	5
	● 369B	1.5 2 2.5 3 4 5 6 8 10



### 369 H9B Hexagon ball end L-key set in Classic holder. Black finish, 9 pcs.

Blade: Chrome-vanadium steel, through-hardened, black finish.  
 Standards: Based on ISO 2936L.  
 Application: Especially for screws that are difficult to access.  
 Extra: Popular key sizes kept in a well-organised holder.  
 Simple, rapid operation with solid stopping point for L-keys.  
 The ball end enables the user to work at angles up to 25°.

Order-No.	Series	↔
03879	369 H9B	5
	● 369B	1.5 2 2.5 3 4 5 6 8 10

### SB 369 S9B Ball end hex L-key set in ProStar. Black finish, 9 pcs. Blister packed.

Order-No.	Series	↔
07193	SB 369 S9B	5
	● 369B	1.5 2 2.5 3 4 5 6 8 10

### SB 369 H9B Hexagon ball end L-key set in Classic holder. Black finish, 9 pcs. Blister packed.

Order-No.	Series	↔
03992	SB 369 H9B	10
	● 369B	1.5 2 2.5 3 4 5 6 8 10

## For Allen screws (metric).

**369 H7B** Hexagon ball end L-key set in Classic holder.  
Black finish, 7 pcs.

Blade: Chrome-vanadium steel, through-hardened, black finish.  
Standards: Based on ISO 2936L.  
Application: Especially for screws that are difficult to access.  
Extra: Popular key sizes kept in a well-organised holder.  
Simple, rapid operation with solid stopping point for L-keys.  
The ball end enables the user to work at angles up to 25°.

Order-No.	Series							
03878	369 H7B							5
	● 369B	1.5	2	2.5	3	4	5	6

**SB 369 H7B** Hexagon ball end L-key set in Classic holder.  
Black finish, 7 pcs.  
Blister packed.

Order-No.	Series							
03991	SB 369 H7B							10
	● 369B	1.5	2	2.5	3	4	5	6

## For Allen screws (metric).

**352 S9** Hexagon L-key set in ProStar holder.  
Nickel-plated, 9 pcs.

Blade: Chrome-vanadium steel, through hardened, nickel-plated.  
Standards: Based on ISO 2936L.  
Extra: Space saving ProStar allows the easy removal of each key without moving any others.

Order-No.	Series							
07181	352 S9							5
	● 352	1.5	2	2.5	3	4		
		5	6	8	10			

**SB 352 S9** Hexagon L-key set in ProStar holder.  
Nickel-plated, 9 pcs.  
Blister packed.

Order-No.	Series							
07190	SB 352 S9							5
	● 352	1.5	2	2.5	3	4		
		5	6	8	10			

**352** Hex L-key, long.

Blade: Chrome-vanadium steel, through hardened, nickel-plated.  
Standards: Based on ISO 2936L.

Order-No.	●	▬	▬	▬
01201	1.5	91	15	10
01202	2	101	18	10
01203	2.5	113	20	10
01204	3	128	23	10
01206	4	142	29	10
01207	5	163	33	10
01208	6	184	38	10
01209	7	194	41	5
01210	8	206	44	10
36450	9	217	47	5
01211	10	231	50	5
01212	12	259	57	5
01213	14	291	70	5
01214	17	333	80	5
01215	19	375	89	5

**352 H11** L-key set in Compact holder.  
Bright nickel-plated, 11 pcs.

Blade: Chrome-vanadium steel, through hardened, nickel-plated.  
Standards: Based on ISO 2936L.  
Extra: Thanks to its compact form the Wiha Compact holder fits perfectly into any folding rule pocket.  
Including SW 7 and SW 9 special sizes.

Order-No.	Series							
36451	352 H11							5
	● 352	1.5	2	2.5	3	4		
		5	6	7	8	9	10	

# Wiha hexagon L-key (metric).

For Allen screws (metric).



**352 H9** Hexagon L-key set in Compact holder.  
Nickel-plated, 9 pcs.

Blade: Chrome-vanadium steel, through hardened, nickel-plated.  
Standards: Based on ISO 2936L.  
Extra: Thanks to its compact dimensions, this holder fits easily into every ruler pocket.  
Popular key sizes kept in a well-organized holder.

Order-No.	Series							
01222	352 H9							5
	● 352	1.5	2	2.5	3	4		
		5	6	8	10			

For Allen screws (metric).



**352B** Hex L-key, long.

Blade: Chrome-vanadium steel, through-hardened, black finish.  
Standards: Based on ISO 2936L.

Order-No.	●			
06358	0.7	67	6	5
06359	0.9	70	9	5
06360	1.3	80	13	5
06059	1.5	91	15	5
06361	2	101	18	5
06362	2.5	113	20	5
06363	3	128	23	5
06364	4	142	29	10
06365	5	163	33	10
06366	6	184	38	10
06367	7	194	41	5
06368	8	206	44	10
06369	10	231	50	5
06370	12	259	57	5
06371	14	291	70	5



**352 H7** Hexagon L-key set in Classic holder.  
Nickel-plated, 7 pcs.

Blade: Chrome-vanadium steel, through hardened, nickel-plated.  
Standards: Based on ISO 2936L.  
Extra: Popular key sizes kept in a well-organized holder.  
Simple, rapid operation with solid stopping point for L-keys.

Order-No.	Series								
01220	352 H7								5
	● 352	1.5	2	2.5	3	4	5	6	



**352 B8** Hex L-key set in sliding box.  
Nickel-plated, 8 pcs.

Blade: Chrome-vanadium steel, through hardened, nickel-plated.  
Standards: Based on ISO 2936L.  
Extra: Large, impact resistant sliding box.

Order-No.	Series									
01216	352 B8									5
	● 352	2	2.5	3	4	5	6	8	10	

## Wiha Info

Colour-coding system:

- red:**  
metric hex blades
- yellow:**  
inch hex blades
- green:**  
TORX® blades
- light green:**  
TORX PLUS® blades



**For Allen screws (metric).**



**352 H9B** Hexagon L-key set in Classic holder.  
Black finish, 9 pcs.

Blade: Chrome-vanadium steel, through-hardened, black finish.  
Standards: Based on ISO 2936L.  
Extra: Popular key sizes kept in a well-organised holder.  
Simple, rapid operation with solid stopping point for L-keys.

Order-No.	Series						
06386	352 H9B						5
	● 352B	1.5	2	2.5	3	4	
		5	6	8	10		



**352 H7B** Hexagon L-key set in Classic holder.  
Black finish, 7 pcs.

Blade: Chrome-vanadium steel, through-hardened, black finish.  
Standards: Based on ISO 2936L.  
Extra: Popular key sizes kept in a well-organised holder.  
Simple, rapid operation with solid stopping point for L-keys.

Order-No.	Series							
06384	352 H7B							5
	● 352B	1.5	2	2.5	3	4	5	6



**352 HM5B** Hexagon L-key set in Classic holder.  
Black finish, 5 pcs.

Blade: Chrome-vanadium steel, through-hardened, black finish.  
Standards: Based on ISO 2936L.  
Extra: Popular key sizes kept in a well-organised holder.  
Simple, rapid operation with solid stopping point for L-keys.

Order-No.	Series						
06382	352 HM5B						10
	● 352B	0.7	0.9	1.3	1.5	2	

**For Allen screws (metric).**



**351** Hex L-key, short.

Blade: Chrome-vanadium steel, through hardened, nickel-plated.  
Standards: ISO 2936K.

Order-No.	●			
01144	1.5	46	15	10
01145	2	51	18	10
01146	2.5	57	20	10
01147	3	64	23	10
01148	3.5	70	26	5
01149	4	72	29	10
01150	4.5	80	31	5
01151	5	83	33	10
01152	5.5	90	35	5
01153	6	94	38	10
01154	7	99	41	5
01155	8	105	44	10
01156	9	114	47	5
01157	10	119	50	5
01158	11	129	53	5
01159	12	134	57	5
01160	14	151	70	5
01161	17	173	80	5
01162	19	195	89	5



**351 H11** L-key set in Compact holder.  
Bright nickel-plated, 11 pcs.

Blade: Chrome-vanadium steel, through hardened, nickel-plated.  
Standards: ISO 2936K.  
Extra: Thanks to its compact form the Wiha Compact holder fits perfectly into any folding rule pocket.  
Including SW 7 and SW 9 special sizes.

Order-No.	Series											
36449	351 H11											5
	● 351	1.5	2	2.5	3	4						
		5	6	7	8	9	10					

# Wiha hexagon L-key (metric).

For Allen screws (metric).



**351 H9** Hexagon L-key set in Compact holder.  
Nickel-plated, 9 pcs.

Blade: Chrome-vanadium steel, through hardened, nickel-plated.  
Standards: ISO 2936K.  
Extra: Thanks to its compact dimensions, this holder fits easily into every ruler pocket.  
Popular key sizes kept in a well-organised holder.

Order-No.	Series									
01174	351 H9									10
	● 351	1.5	2	2.5	3	4				
		5	6	8	10					

**SB 351 H9** Hexagon L-key set in Compact holder.  
Nickel-plated, 9 pcs.  
Blister packed.

Order-No.	Series									
03734	SB 351 H9									5
	● 351	1.5	2	2.5	3	4				
		5	6	8	10					



**351 H7** Hexagon L-key set in Classic holder.  
Nickel-plated, 7 pcs.

Blade: Chrome-vanadium steel, through hardened, nickel-plated.  
Standards: ISO 2936K.  
Extra: Popular key sizes kept in a well-organised holder.  
Simple, rapid operation with solid stopping point for L-keys.

Order-No.	Series								
01172	351 H7								10
	● 351	1.5	2	2.5	3	4	5	6	

For Allen screws (metric).



**351 B8** Hex L-key set in sliding box.  
Nickel-plated, 8 pcs.

Blade: Chrome-vanadium steel, through hardened, nickel-plated.  
Standards: ISO 2936K.  
Extra: Small, impact resistant sliding box.

Order-No.	Series									
01166	351 B8									10
	● 351	2	2.5	3	4	5	6	8	10	



**351 R8** Hex L-key set on keyring.  
Nickel-plated, 8 pcs. In plastic pouch.

Blade: Chrome-vanadium steel, through hardened, nickel-plated.  
Standards: ISO 2936K.  
Extra: Flexible hanging of all keys on a keyring.

Order-No.	Series									
01180	351 R8									10
	● 351	2	2.5	3	4	5	6	8	10	



**351 VB** Hex L-key set in bench stand.  
Nickel-plated, 9 pcs.

Blade: Chrome-vanadium steel, through hardened, nickel-plated.  
Standards: ISO 2936K.  
Extra: Robust metal workbench holder to place on workbench or wall-mount.  
Tip diagrams printed to scale.

Order-No.	Series								
01182	351 VB								1
	● 351	2.5	3	4	5	6			
		8	10	12	14				

**For Allen screws (metric).**



**359 Hex L-key with pivot.**

Blade: Chrome-vanadium steel, through hardened, nickel-plated.  
 Standards: DIN 6911.  
 Application: Fits hex socket screws with low head and centre hole. With key guidance according to DIN 6912.

Order-No.	⊙	↔	↵	▬
01255	3	64	23	10
01256	4	72	29	10
01257	5	83	33	10
01258	6	94	38	10
01259	8	105	44	10
01260	10	119	50	5
01261	12	134	57	5
01262	14	151	70	5
01263	17	173	80	5



**359 T5 Hexagon L-key set with pin in a roll-up pouch.**

Blade: Chrome-vanadium steel, through hardened, nickel-plated.  
 Standards: DIN 6911.  
 Application: Fits hex socket screws with low head and centre hole. With key guidance according to DIN 6912.  
 Extra: Robust roll-up pouches allows space-saving storage of tools.

Order-No.	Series	▬
33391	359 T5	1
⊙ 359	3 4 5 6 8	

**For Allen screws (metric).**



**350 Hex L-key, short.**

Blade: Chrome-vanadium steel, through-hardened, black finish.  
 Standards: ISO 2936K.

Order-No.	⊙	↔	↵	▬
06218	1.3	41	13	10
01121	1.5	46	15	10
01122	2	51	18	10
01123	2.5	57	20	10
01124	3	64	23	10
01126	4	72	29	10
01128	5	83	33	10
01130	6	94	38	10
01131	7	99	41	10
01132	8	105	44	10
01133	9	112	47	5
01134	10	119	50	5
01135	11	126	53	5
01136	12	134	57	5
01137	14	151	70	5
01138	17	173	80	5
01139	19	195	89	5
01140	22	217	102	1
01141	24	241	114	1
01142	27	271	127	1
01143	32	339	157	1



**350 H9 Hexagon L-key set in Classic holder. Black finish, 9 pcs.**

Blade: Chrome-vanadium steel, through-hardened, black finish.  
 Standards: ISO 2936K.  
 Extra: Popular key sizes kept in a well-organised holder. Simple, rapid operation with solid stopping point for L-keys.

Order-No.	Series	▬
06379	350 H9	10
⊙ 350	1.5 2 2.5 3 4 5 6 8 10	



**350 H7 Hexagon L-key set in Classic holder. Black finish, 7 pcs.**

Order-No.	Series	▬
06378	350 H7	10
⊙ 350	1.5 2 2.5 3 4 5 6	

# Wiha hexagon L-key (inch).

## For Allen screws (inch).



**369 Zoll** Ball end hex L-key, long.  
Inch sizes.

Blade: Chrome-vanadium steel, through-hardened, black finish.  
Standards: Based on ASME B18.3.  
Application: Especially for inch-sized screws that are difficult to access.  
Extra: The ball end enables the user to work at angles up to 25°.

Order-No.	●	↔	↓	mm	↔
01422	0.05	72	13	1.27	10
01423	1/16	80	15	1.59	10
01431	5/64	88	18	1.98	10
01427	3/32	101	20	2.38	10
01433	7/64	111	21	2.78	10
01425	1/8	121	23	3.18	10
01434	9/64	136	27	3.57	10
01430	5/32	148	29	3.97	10
01426	3/16	163	33	4.76	10
01432	7/32	176	36	5.56	10
01424	1/4	191	38	6.35	10
01429	5/16	210	43	7.94	10
01428	3/8	232	49	9.53	5

## For Allen screws (inch).



**369 SZ13B** Ball end hex L-key set in ProStar.  
Black finish, 13 pcs. inch design.

Blade: Chrome-vanadium steel, through-hardened, black finish.  
Standards: Based on ASME B18.3.  
Application: Especially for inch-sized screws that are difficult to access.  
Extra: Space saving ProStar allows the easy removal of each key without moving any others.

Order-No.	Series	↔
24189	369 SZ13B	5
● 369 Zoll	0.05 1/16 5/64 3/32 7/64 1/8 9/64 5/32 3/16 7/32 1/4 5/16 3/8	

**SB 369 SZ13B** Hexagon ball end L-key set in Classic holder.  
Black finish, 13 pcs. inch design.  
Blister packed.

Order-No.	Series	↔
24851	SB 369 SZ13B	5
● 369 Zoll	0.05 1/16 5/64 3/32 7/64 1/8 9/64 5/32 3/16 7/32 1/4 5/16 3/8	



**369 HZ8** Hexagon ball end L-key set in Classic holder.  
Black finish, 8 pcs. inch design.

Blade: Chrome-vanadium steel, through-hardened, black finish.  
Standards: Based on ASME B18.3.  
Application: Especially for inch-sized screws that are difficult to access.  
Extra: Popular key sizes kept in a well-organised holder.  
Simple, rapid operation with solid stopping point for L-keys.

Order-No.	Series	↔
01420	369 HZ8	5
● 369 Zoll	5/64 3/32 1/8 5/32 3/16 7/32 1/4 5/16	

**SB 369 HZ8** Hexagon ball end L-key set in Classic holder.  
Black finish, 8 pcs. inch design.  
Blister packed.

Order-No.	Series	↔
02939	SB 369 HZ8	10
● 369 Zoll	5/64 3/32 1/8 5/32 3/16 7/32 1/4 5/16	

## For Allen screws (inch).

**351 Zoll** Hex L-key, short.  
Inch sizes.

Blade: Chrome-vanadium steel, through hardened, nickel-plated.  
Standards: Based on ASME B18.3.  
Application: For all popular inch screws.

Order-No.	●	↔	!↔	mm	↔
25626	0.05	45	15	1.27	10
01184	1/16	47	17	1.59	10
01194	5/64	51	18	1.98	10
01189	3/32	55	20	2.38	10
22406	7/64	58	21	2.78	10
01187	1/8	62	22	3.18	10
01200	9/64	63	24	3.57	10
01193	5/32	67	26	3.97	10
01188	3/16	74	29	4.76	10
01197	7/32	84	33	5.56	10
01186	1/4	90	36	6.35	10
01192	5/16	102	40	7.94	10
01191	3/8	116	45	9.53	5
01185	1/2	146	54	12.70	5
01198	9/16	160	59	14.29	5
01195	5/8	175	64	15.88	5
01190	3/4	203	73	19.05	5

## For Allen screws (inch).

**351 SZ13** Hexagon L-key set in ProStar holder.  
Nickel-plated, 13 pcs. Inch sizes.

Blade: Chrome-vanadium steel, through hardened, nickel-plated.  
Standards: Based on ASME B18.3.  
Application: For all popular inch screws.  
Extra: Space saving ProStar allows the easy removal of each key without moving any others.

Order-No.	Series	↔
25610	351 SZ13	5
● 351 Zoll	0.05 1/16 5/64 3/32 7/64 1/8 9/64 5/32 3/16 7/32 1/4 5/16 3/8	

**351 HZ8** Hexagon L-key set in Classic holder.  
Nickel-plated, 8 pcs. Inch sizes.

Blade: Chrome-vanadium steel, through hardened, nickel-plated.  
Standards: Based on ASME B18.3.  
Application: For all popular inch screws.  
Extra: Popular key sizes kept in a well-organized holder.  
Simple, rapid operation with solid stopping point for L-keys.

Order-No.	Series	↔
01176	351 HZ8	10
● 351 Zoll	5/64 3/32 1/8 5/32 3/16 7/32 1/4 5/16	

## Wiha Info

## Colour-coding system:

- red:**  
metric hex blades
- yellow:**  
inch hex blades
- green:**  
TORX® blades
- light green:**  
TORX PLUS® blades



# Wiha TORX® MagicSpring®.

Holds TORX® and TORX PLUS® screws securely in place.



**Wiha MagicSpring®:**  
a stainless steel spring securely holds  
TORX® and TORX PLUS® screws.

No more annoying and time-consuming hunting around for TORX® or TORX PLUS® screws that have apparently vanished into thin air. With Wiha's ingenious new tool, the MagicSpring®, TORX® or TORX PLUS® screws\* are kept firmly where you want them. The highlight of the "MagicSpring®" tools is the stainless steel "magical" retaining spring that, together with a thin cover disc, is laser-welded to the tip of the blade.

This completely new innovation acts as a clamp between tool and TORX® or TORX PLUS® screw, so that the latter is firmly gripped by the tip of the blade. The new tools are especially beneficial when turning particularly small screws or when turning screws in areas that are difficult to access. Simply place the screw on the tip of the blade and start to turn. No more screws will fall to the ground or disappear between components.



*Insertion and removal of TORX® and TORX PLUS® screws is safe and comfortable thanks to MagicSpring® from Wiha.*

*\* TORX® and TORX PLUS® screws manufactured according to Camcar Textron specifications.*



*As the clamping action is purely mechanical, MagicSpring® also gets a firm grip on TORX® or TORX PLUS® screws made of aluminium, stainless steel, plastic and titanium.*



*The retaining spring is a completely new technical solution that, together with a thin cover disc, is laser-welded to the tip of the blade.*



## Wiha TORX® MagicSpring®.

- MagicSpring® retaining spring made of stainless steel gets a firm hold on every TORX® or TORX PLUS® screw
- No more annoying searching for dropped screws
- Ideal for areas that are difficult to access
- Made of high-quality materials in the renowned Wiha quality
- Also suitable for TORX® or TORX PLUS® screws made of aluminium, stainless steel, plastic and titanium

For TORX® screws.



**366R** TORX® MagicSpring® L-key, long.

Retaining spring holds TORX® screws in place.

Blade: Chrome-vanadium steel, through-hardened, black finish.

Application: For setting and tightening TORX® screws in difficult to access areas.

Order-No.	⊕	↔	⌞	⦿	⌞
31233	T6	80	15	1/16	10
31234	T7	88	18	5/64	10
31235	T8	101	20	3/32	10
31236	T9	111	21	7/64	10
31237	T10	121	23	1/8	10
31238	T15	136	27	9/64	10
31239	T20	148	29	5/32	10
31240	T25	163	33	3/16	10
31241	T27	176	36	7/32	10
31242	T30	191	38	1/4	10
31243	T40	210	43	5/16	10
31244	T45	232	49	3/8	10

For TORX® screws.



**366R HZ13** TORX® MagicSpring® L-key set in ErgoStar holder.  
Black finish, 13 pcs.

Blade: Chrome-vanadium steel, through-hardened, black finish.

Application: For setting and tightening TORX® screws in difficult to access areas.

Extra: Mechanical operation of the space-saving ErgoStar holder makes simplest removal of each individual L-key possible without movement of the others.

Fastening spring (from size T6) firmly holds TORX® screws.

Order-No.	Series	⌞
36503	366R HZ13	5
⊕	366	T5
⊕	366R	T6 T7 T8 T9 T10 T15 T20 T25 T27 T30 T40 T45

**SB 366R HZ13** TORX® MagicSpring® L-key set in ErgoStar holder.  
Black finish, 13 pcs.

Blister packed.

With practical wall bracket.

Order-No.	Series	⌞
36504	SB 366R HZ13	5
⊕	366	T5
⊕	366R	T6 T7 T8 T9 T10 T15 T20 T25 T27 T30 T40 T45

 red dot design award  
winner 2010

 Focus Open  
Silver 2011

Wiha Info



Wiha ErgoStar

The right idea:  
a flowing movement means  
all L-keys are ready for removal.

Wiha Info



Wiha TORX® MagicSpring®.  
stainless steel spring  
reliably holds TORX® or  
TORX PLUS® screws in place.

# Wiha TORX® MagicSpring®.

Holds TORX® and TORX PLUS® screws securely in place.

For TORX® screws.



**366R SZ13** TORX® MagicSpring® L-key set in ProStar holder, 13-pcs.  
Retaining spring holds TORX® screws in place.

Blade: Chrome-vanadium steel, through-hardened, black finish.  
Application: For setting and tightening TORX® screws in difficult to access areas.  
Extra: Makes simple removal of each individual key possible without movement of the others.

Order-No.	Series	
31492	366R SZ13	5
	366	T5
	366R	T6 T7 T8 T9 T10 T15 T20 T25 T27 T30 T40 T45

**SB 366R SZ13** TORX® MagicSpring® L-key set in ProStar holder, 13-pcs.  
Blister packed.

Order-No.	Series	
31923	SB 366R SZ13	5
	366	T5
	366R	T6 T7 T8 T9 T10 T15 T20 T25 T27 T30 T40 T45

For TORX® screws.



**366R H8** TORX® MagicSpring® L-key set in Classic holder, 8-pcs.  
Retaining spring holds TORX® screws in place.

Blade: Chrome-vanadium steel, through-hardened, black finish.  
Application: For setting and tightening TORX® screws in difficult to access areas.  
Extra: Popular key sizes kept in a well-organised holder.  
Simple, rapid operation with solid stopping point for L-keys.

Order-No.	Series	
34740	366R H8	5
	366R	T9 T10 T15 T20 T25 T27 T30 T40

**SB 366R H8** TORX® MagicSpring® L-key set in Classic holder, 8-pcs.  
Retaining spring holds TORX® screws in place.  
Blister packed.

Order-No.	Series	
34741	SB 366R H8	10
	366R	T9 T10 T15 T20 T25 T27 T30 T40



**366R HM7** TORX® MagicSpring® L-key set in Classic holder, 7-pcs.  
Retaining spring holds TORX® screws in place.

Blade: Chrome-vanadium steel, through-hardened, black finish.  
Application: For setting and tightening TORX® screws in difficult to access areas.  
Extra: Popular key sizes kept in a well-organised holder.  
Simple, rapid operation with solid stopping point for L-keys.

Order-No.	Series	
33753	366R HM7	5
	366R	T6 T7 T8 T9 T10 T15 T20

**SB 366R HM7** TORX® MagicSpring® L-key set in Classic holder, 7-pcs.  
Retaining spring holds TORX® screws in place.  
Blister packed.

Order-No.	Series	
33754	SB 366R HM7	5
	366R	T6 T7 T8 T9 T10 T15 T20

For TORX PLUS® screws.



**371RIP** TORX PLUS® L-key.  
With MagicSpring®.

Blade: Chrome-vanadium steel, through-hardened, black finish.  
 Application: For all TORX PLUS® screw tasks.  
 Extra: MagicSpring® made from stainless steel holds TORX PLUS®-screws tight at various angles.  
 The stronger profile of the TORX PLUS® tip allows up to 25% extra torque than the TORX® profile.

Attention: TORX PLUS® keys cannot be used with TORX® screws.

Order-No.	Series	Blade Length	Tip Length	Tip Diameter	Tip Width
29197	6IP	65	16	1/16	10
29198	7IP	71	18	5/64	10
29199	8IP	77	20	3/32	10
29200	9IP	83	22	7/64	10
29201	10IP	90	24	1/8	10
29202	15IP	97	26	9/64	10
29203	20IP	104	29	5/32	10
29204	25IP	112	33	3/16	10
29205	27IP	122	36	7/32	10
29206	30IP	132	40	1/4	10
29207	40IP	143	44	5/16	10

For TORX PLUS® screws.



**371RIP H8** TORX PLUS® MagicSpring® L-key set in Classic holder, 8-pcs.  
Retaining spring holds TORX PLUS® screws in place.

Blade: Chrome-vanadium steel, through-hardened, black finish.  
 Application: For all TORX PLUS® screw tasks.  
 Extra: Popular key sizes kept in a well-organised holder.  
 Simple, rapid operation with solid stopping point for L-keys.  
 MagicSpring® made from stainless steel holds TORX PLUS®-screws tight at various angles.

Order-No.	Series	Blade Length	Tip Length	Tip Diameter	Tip Width					
34742	371RIP H8	9IP	10IP	15IP	20IP	25IP	27IP	30IP	40IP	5



**371RIP HM7** TORX PLUS® MagicSpring® L-key set in Classic holder, 7-pcs.  
Retaining spring holds TORX PLUS® screws in place.

Blade: Chrome-vanadium steel, through-hardened, black finish.  
 Application: For all TORX PLUS® screw tasks.  
 Extra: Popular key sizes kept in a well-organised holder.  
 Simple, rapid operation with solid stopping point for L-keys.  
 MagicSpring® made from stainless steel holds TORX PLUS®-screws tight at various angles.

Order-No.	Series	Blade Length	Tip Length	Tip Diameter	Tip Width				
29208	371RIP HM7	6IP	7IP	8IP	9IP	10IP	15IP	20IP	5



Wiha TORX® MagicSpring®.  
 stainless steel spring  
 reliably holds TORX® or  
 TORX PLUS® screws in place.

# Wiha TORX® ball end.

Simpler, more powerful, safer.



*Plenty of room to manoeuvre: The ball end enables access to the TORX® screw at an angle of up to 25°.*

Tight spaces that only allow fastening and unfastening in at an angle: In these "problem zones" for TORX® screws, Wiha TORX® ball end tools are in demand. The advantages for the user are obvious: With the improved geometry of the ball end, TORX® screws can now be screwed in and out even at angles up to 25°. As a result, maximum torques are no longer a problem even in difficult installation positions. Wearing of the tool and screw head is noticeably reduced.

And Wiha is also pursuing a different path in production. Thanks to an innovative manufacturing process, cold forming, the TORX® ball end gains a great deal of strength.

So that these advantages benefit a broad range of applications, the Wiha TORX® ball end is integrated in several types of tools and is available in proven Wiha quality:

- as an L-key in sizes T9 to T40, separately or as a set with a holder
- as a bit with the lengths 50, 70 and 90 mm
- as a screwdriver with the ergonomic SoftFinish® handle, through-hardened, brushed chrome-plated blade and precision-fitting ChromTop® blade tip

Thanks to their ruggedness, flexibility and diversity, Wiha TORX® ball end tools are indispensable for any user who has to depend on a long tool life under difficult working conditions.



With elongated TORX® profile behind ball end.



## Wiha TORX® ball end.

- With optimised TORX® ball end geometry
- Increased strength thanks to the special cold forming on a system developed by Wiha especially for this purpose
- Enables fastening and unfastening at angles up to 25°
- Simple insertion of the tool/bit and fastening/unfastening, especially in hard-to-reach locations
- Broad product range: As an L-key, as a bit and as a SoftFinish® screwdriver



## For TORX® screws.

**366BE** TORX® ball end L-key, long.

Blade: Chrome-vanadium steel, through-hardened, black finish.

Application: For all hard-to-reach TORX® screws.

Extra: The TORX® ball end enables fastening and unfastening at an angle of up to 25°.

With elongated TORX® profile behind ball end.

Order-No.	Series	Blade	Length	Width	Height	Quantity
32386	T9	111	21	7/64		10
32387	T10	121	23	1/8		10
32388	T15	136	27	9/64		10
32389	T20	148	29	5/32		10
32390	T25	163	33	3/16		10
32391	T27	176	36	7/32		10
32392	T30	191	38	1/4		10
32393	T40	210	43	5/16		10
33749	T45	232	49	3/8		10
33750	T50	232	49	3/8		10

**366BE HZ13** TORX® ball end L-key set in ErgoStar holder.

Black finish, 13 pcs.

Blade: Chrome-vanadium steel, through-hardened, black finish.

Application: For all hard-to-reach TORX® screws.

Extra: Mechanical operation of the space-saving ErgoStar holder makes simplest removal of each individual L-key possible without movement of the others.

TORX® ball end (from T9 size) enables fastening at an angle of up to 25°. With elongated TORX® profile behind ball end.

Order-No.	Series	Blade	Length	Width	Height	Quantity	
36487	366BE HZ13					5	
	366	T5	T6	T7	T8		
	366BE	T9	T10	T15	T20	T25	T27
		T30	T40	T45			

**SB 366BE HZ13** TORX® ball end L-key set in ErgoStar holder.

Black finish, 13 pcs.

Blister packed.

With practical wall bracket.

Order-No.	Series	Blade	Length	Width	Height	Quantity	
36486	SB 366BE HZ13					5	
	366	T5	T6	T7	T8		
	366BE	T9	T10	T15	T20	T25	T27
		T30	T40	T45			

## For TORX® screws.

**366BE SZ13** TORX® ball end L-key set in ProStar holder.

Black finish, 13 pcs.

Blade: Chrome-vanadium steel, through-hardened, black finish.

Application: For all hard-to-reach TORX® screws.

Extra: Space saving ProStar allows the easy removal of each key without moving any others.

The TORX® ball end enables fastening and unfastening at an angle of up to 25°. With elongated TORX® profile behind ball end.

Order-No.	Series	Blade	Length	Width	Height	Quantity	
33751	366BE SZ13					5	
	366	T5	T6	T7	T8		
	366BE	T9	T10	T15	T20	T25	T27
		T30	T40	T45			

**SB 366BE SZ13** TORX® ball end L-key set in ProStar holder.

Black finish, 13 pcs.

Blister packed.

Order-No.	Series	Blade	Length	Width	Height	Quantity
33752	SB 366BE SZ13					5

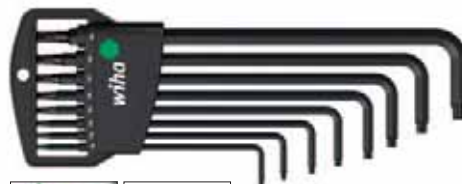
**366BE H8** TORX® ball end L-key set in Classic holder.

Black finish, 8 pcs.

Blade: Chrome-vanadium steel, through-hardened, black finish.

Application: For all hard-to-reach TORX® screws.

Extra: Popular key sizes kept in a well-organised holder.

Simple, rapid operation with solid stopping point for L-keys.

The TORX® ball end enables fastening and unfastening at an angle of up to 25°.

With elongated TORX® profile behind ball end.

Order-No.	Series	Blade	Length	Width	Height	Quantity	
32394	366BE H8					5	
	366BE	T9	T10	T15	T20	T25	T27
		T30	T40				

**SB 366BE H8** TORX® ball end L-key set in Classic holder.

Black finish, 8 pcs.

Blister packed.

Order-No.	Series	Blade	Length	Width	Height	Quantity
32395	SB 366BE H8					10

# Wiha TORX® titanium silver.

TORX® surface for maximum quality requirements.



## Wiha TORX® ball end L-keys.



**NEW**

**366 TS** TORX® L-key, long.

Blade: Chrome-vanadium steel, through-hardened, titanium silver.  
Application: For all TORX® screw applications.

Order-No.	★	↔	└┘	⦿	▬
39106	T5	72	13	0.05	10
39107	T6	80	15	1/16	10
39108	T7	88	18	5/64	10
39109	T8	101	20	3/32	10
39110	T9	111	21	7/64	10
39111	T10	121	23	1/8	10
39112	T15	136	27	9/64	10
39113	T20	148	29	5/32	10
39114	T25	163	33	3/16	10
39115	T27	176	36	7/32	10
39116	T30	191	38	1/4	10
39117	T40	210	43	5/16	10
39118	T45	232	49	3/8	10



## Wiha TORX® titanium silver.

- Designed for ideal corrosion protection
- No more annoying oil or wax on the L-keys
- Especially long service life
- Ensures an accurate perfect fit in the screw

The new titanium silver surface for TORX® L-keys is a special process of surface refinement. This surface is ideally suited for all applications indoors and outdoors and fulfils maximum quality requirements. Titanium silver provides significantly more corrosion protection compared to the conventional, oiled, black TORX® L-keys. This makes oily fingers or re-oiling of the L-keys to maintain the corrosion protection a thing of the past. The new functional coating guarantees TORX® L-keys fit in the screw accurately, in contrast to conventional chrome coating.



**NEW**

**366 SZ13 TS** TORX® L-key set in ProStar holder. Titanium silver, 13-pcs.

Blade: Chrome-vanadium steel, through-hardened, titanium silver.  
Application: For all TORX® screw applications.  
Extra: Space saving ProStar allows the easy removal of each key without moving any others.  
All keys from T5 to T45 in one set.

Order-No.	Series	▬
39104	366 SZ13 TS	5
★	366 TS	T5 T6 T7 T8 T9 T10 T15 T20 T25 T27 T30 T40 T45

**NEW**

**SB 366 SZ13TS** TORX® L-key set in ProStar holder. Titanium silver, 13-pcs. Blister packed.

Order-No.	Series	▬
39105	SB 366 SZ13TS	5
★	366 TS	T5 T6 T7 T8 T9 T10 T15 T20 T25 T27 T30 T40 T45

# Wiha TORX® L-keys.

For TORX® screws.



## 366 TORX® L-key, long.

Blade: Chrome-vanadium steel, through-hardened, black finish.

Application: For all TORX® screw applications.

Order-No.	⊕	↔	!↖	⊖	↔
24313	T5	72	13	0.05	10
24314	T6	80	15	1/16	10
24315	T7	88	18	5/64	10
24316	T8	101	20	3/32	10
24317	T9	111	21	7/64	10
24318	T10	121	23	1/8	10
24319	T15	136	27	9/64	10
24320	T20	148	29	5/32	10
24321	T25	163	33	3/16	10
24322	T27	176	36	7/32	10
24323	T30	191	38	1/4	10
24324	T40	210	43	5/16	10
24325	T50	232	49	3/8	10

For TORX® screws.



## 366 H8 TORX® L-key set in Classic holder.

Black finish, 8 pcs.

Blade: Chrome-vanadium steel, through-hardened, black finish.

Application: For all TORX® screw applications.

Extra: Popular key sizes kept in a well-organised holder.  
Simple, rapid operation with solid stopping point for L-keys.

Order-No.	Series	↔
34736	366 H8	5
⊕ 366	T9 T10 T15 T20 T25 T27 T30 T40	

## SB 366 H8 TORX® L-key set in Classic holder.

Black finish, 8 pcs.

Blister packed.

Order-No.	Series	↔
34737	SB 366 H8	10
⊕ 366	T9 T10 T15 T20 T25 T27 T30 T40	



## 366 SZ13 TORX® L-key set in ProStar holder.

Black finish, 13 pcs.

Blade: Chrome-vanadium steel, through-hardened, black finish.

Application: For all TORX® screw applications.

Extra: Space saving ProStar allows the easy removal of each key without moving any others.

All keys from T5 to T50 in one set.

Order-No.	Series	↔
24312	366 SZ13	5
⊕ 366	T5 T6 T7 T8 T9 T10 T15 T20 T25 T27 T30 T40 T50	

## SB 366 SZ13 TORX® L-key set in ProStar holder.

Black finish, 13 pcs.

Blister packed.

Order-No.	Series	↔
24852	SB 366 SZ13	5
⊕ 366	T5 T6 T7 T8 T9 T10 T15 T20 T25 T27 T30 T40 T50	

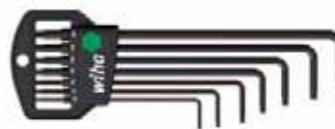

## 366 H7 TORX® L-key set in Classic holder.

Black finish, 7 pcs.

Blade: Chrome-vanadium steel, through-hardened, black finish.

Application: For all TORX® screw applications.

Extra: Popular key sizes kept in a well-organised holder.  
Simple, rapid operation with solid stopping point for L-keys.

Order-No.	Series	↔
34738	366 H7	5
⊕ 366	T6 T7 T8 T9 T10 T15 T20	

# Wiha TORX®-L-keys.

For TORX® screws.



## 363 TORX® L-key, short.

Blade: Chrome-vanadium steel, through-hardened, black finish.  
Application: For all TORX® screw applications in confined work spaces.

Order-No.	☼	↔	↵	●	⊔
03764	T5	39	18	2.5	10
01310	T6	41	18	2.5	10
01311	T7	44	18	2.5	10
01312	T8	47	18	2.5	10
01313	T9	51	19	3.0	10
01314	T10	54	20	3.0	10
01315	T15	57	22	3.5	10
01316	T20	62	23	4.0	10
01317	T25	67	25	4.5	10
01318	T27	72	27	5.5	10
01319	T30	79	30	6.0	10
01320	T40	86	33	7.0	10
01321	T45	90	36	8.0	10
01322	T50	104	41	9.0	10
01323	T55	120	47	12.0	10
01324	T60	134	52	14.0	10



## 363 H8 TORX® L-key set in Classic holder. Black finish, 8 pcs.

Blade: Chrome-vanadium steel, through-hardened, black finish.  
Application: For all TORX® screw applications in confined work spaces.  
Extra: Common key sizes are clearly stored in the Classic holder.

Order-No.	Series	⊔
36461	363 H8	5
☼ 363	T9 T10 T15 T20 T25 T27 T30 T40	

## SB 363 H8 TORX® L-key set in Classic holder. Black finish, 8 pcs. Blister packed.

Order-No.	Series	⊔
36457	SB 363 H8	10



## 363 H7 TORX® L-key set in Classic holder. Black finish, 7 pcs.

Blade: Chrome-vanadium steel, through-hardened, black finish.  
Application: For all TORX® screw applications in confined work spaces.  
Extra: Common key sizes are clearly stored in the Classic holder.

Order-No.	Series	⊔
36460	363 H7	5
☼ 363	T6 T7 T8 T9 T10 T15 T20	

For TORX® screws.



## 363 VB TORX® L-key set in bench stand. Black finish, 9 pcs.

Blade: Chrome-vanadium steel, through-hardened, black finish.  
Application: For all TORX® screw applications in confined work spaces.  
Extra: Robust metal workbench holder to place on workbench or wall-mount.  
Tip diagrams printed to scale.

Order-No.	Series	⊔
01326	363 VB	1
☼ 363	T10 T15 T20 T25 T30 T40 T50 T55 T60	



## 355 XZN® L-key, short.

Blade: Chrome-vanadium steel, through hardened, nickel-plated.  
Application: For XZN® multipoint socket screws.

Order-No.	☼	↔	↵	⊔
01243	M5	76	30	10
01244	M6	86	34	10
01245	M8	98	38	10
01246	M10	110	46	10
01247	M12	124	52	10
01248	M14	138	58	10
01249	M16	156	71	10



## NEW 355T5 XZN® L-keys in a roll-up bag.

Blade: Chrome-vanadium steel, through hardened, nickel-plated.  
Application: For XZN® multipoint socket screws.  
Extra: Robust roll-up pouches allows space-saving storage of tools.

Order-No.	Series	⊔
37217	355T5	1
☼ 355	M5 M6 M8 M10 M12	

# Wiha L-keys.

## For TORX® Tamper Resistant screws.



### 363TR TORX® Tamper Resistant L-key, short.

Blade: Chrome-vanadium steel, through-hardened, black finish.  
 Application: For popular TORX® Tamper Resistant screws (with security pin).  
 Extra: Borehole in every blade tip.

Order-No.	⊕	↔	⊥	●	⊖
24105	T7H	44	18	2.5	10
24107	T8H	47	18	2.5	10
24109	T9H	51	19	3.0	10
24111	T10H	54	20	3.0	10
24113	T15H	57	22	3.5	10
24115	T20H	62	23	4.0	10
24117	T25H	67	25	4.5	10
24119	T27H	72	27	5.5	10
24121	T30H	79	30	6.0	10
24123	T40H	86	33	7.0	10

## For TORX PLUS® screws.



### 361IP TORX PLUS® L-key, short.

Blade: Chrome-vanadium steel, through-hardened, black finish.  
 Application: For popular TORX PLUS® screws.  
 Extra: The stronger profile of the TORX PLUS® tip allows up to 25% extra torque than the TORX® profile.

Attention: TORX PLUS® keys cannot be used with TORX® screws.

Order-No.	⊕	↔	⊥	●	⊖
24513	6IP	41	18	2.5	10
24515	7IP	44	18	2.5	10
24517	8IP	47	18	2.5	10
24519	9IP	51	19	3.0	10
24521	10IP	54	20	3.0	10
24523	15IP	58	22	3.5	10
24525	20IP	62	23	4.0	10
24527	25IP	67	25	4.5	10
24529	27IP	73	27	5.5	10
24531	30IP	79	30	6.0	10
24533	40IP	88	33	7.0	10



### 363TR H8 TORX® Tamper Resistant L-key set in Classic holder. Black finish, 8 pcs.

Blade: Chrome-vanadium steel, through-hardened, black finish.  
 Application: For popular TORX® Tamper Resistant screws (with security pin).  
 Extra: Common key sizes are clearly stored in the Classic holder.  
 Borehole in every blade tip.

Order-No.	Series	⊖
36462	363TR H8	5
	⊕ 363TR T9H T10H T15H T20H T25H T27H T30H T40H	

### SB 363TR H8 TORX® Tamper Resistant L-key set in Classic holder. Black finish, 8 pcs. Blister packed.

Order-No.	Series	⊖
36458	SB 363TR H8	10
	⊕ 363TR T9H T10H T15H T20H T25H T27H T30H T40H	



### 361IP H8 TORX PLUS® L-key set in Classic holder. Black finish, 8 pcs.

Blade: Chrome-vanadium steel, through-hardened, black finish.  
 Application: For popular TORX PLUS® screws.  
 Extra: Common key sizes are clearly stored in the Classic holder.  
 Attention: TORX PLUS® keys cannot be used with TORX® screws.

Order-No.	Series	⊖
36459	361IP H8	5
	⊕ 361IP 9IP 10IP 15IP 20IP 25IP 27IP 30IP 40IP	

### SB 361IP H8 TORX PLUS® L-key set in Classic holder. Black finish, 8 pcs. Blister packed.

Order-No.	Series	⊖
36456	SB 361IP H8	10
	⊕ 361IP 9IP 10IP 15IP 20IP 25IP 27IP 30IP 40IP	



# Wiha PocketStar.

The right key with the press of a button.

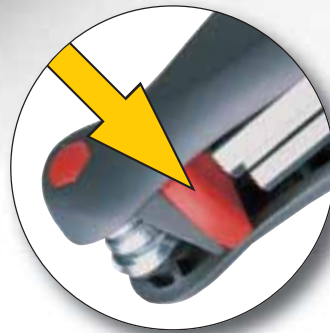

*The unique opening mechanism facilitates an easy selection of the desired key size.*

The Wiha PocketStar fold out offers optimum handling and a wide variety of uses, which are expressed in the form of many practical details.

The ingenious opening mechanism facilitates the simple selection of the required key size from the glass-fibre-reinforced holder.

Wiha solved an important demand of fold-out users: When turning a key into working position only this one moves. The remaining keys stay where they are.

The various working positions offer universal use:

- In the 180° position, the PocketStar is used as a screwdriver.
- 270° stop limit for using the tool as practical lever for high torques.
- Any position can be set between 90° and 270° for a variety of different work applications.

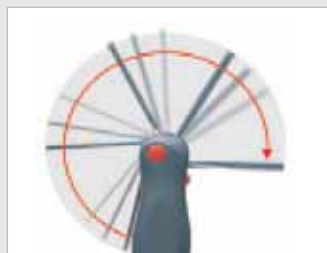

*The 270° stop limit when working on applications with higher safety requirements puts an end to trapped fingers.*



*Three flicks of the wrist and you have an effective screwdriver: take it out of the pocket, press the button and adjust the desired key to 180° or 270°.*



## Wiha PocketStar.

- Innovative opening mechanism for simple selection of the desired key size
- Particularly suitable for use as screwdriver when the blade axis is set at 180° or as practical lever with blade in 270° position
- Ergonomic, glass-fibre-reinforced holder guarantees the easy transfer of even the highest torques
- Can be rotated by any angle between 270° and 90° to save time when working on applications where space is tight
- 270° stop limit for higher safety puts an end to trapped fingers
- Colour-coding system for different drives and dimensional systems delivers great clarity when using several PocketStars
- Covered hex key axes prevents catching on clothes

# Wiha PocketStar.

With hex keys.

For Allen screws (metric).



**369R P7** Ball end hex fold out holder PocketStar.  
With MagicRing®, in large PocketStar, 7 pcs.

Blade: Chrome-vanadium steel, through hardened, electro-plated.  
Handle: Ergonomic, reinforced fibreglass housing, 120 mm long.  
Application: Practical fold out holder for hex screws in the workplace or on the job. Insert screws into or remove from boreholes, especially in difficult to access areas.  
Extra: Robust casing with eject button for simple and easy key selection. MagicRing® of spring steel (from size 3 mm) secures all hex standard screws independently of screw material in any position. The ball end enables the user to work at angles up to 25°.

Order-No.	Series								
23031	369R P7								5
●	2	2.5	3	4	5	6	8		

**SB 369R P7** Ball end hex fold out holder PocketStar.  
With MagicRing®, in large PocketStar, 7 pcs.  
Blister packed with hanging hole.

Order-No.	Series								
23033	SB 369R P7								5
●	2	2.5	3	4	5	6	8		

## Wiha Info

Colour-coding system:

- red:**  
metric hex blades
- yellow:**  
inch hex blades
- green:**  
TORX® blades
- light green:**  
TORX PLUS® blades

For Allen screws (metric).



**351 PG7** Hex fold out holder PocketStar.  
In large PocketStar, 7 pcs.

Blade: Chrome-vanadium steel, through hardened, electro-plated.  
Handle: Ergonomic, reinforced fibreglass housing, 120 mm long.  
Application: Practical fold out holder for hex screws in the workplace or on the job.  
Extra: Robust casing with eject button for simple and easy key selection.

Order-No.	Series								
23040	351 PG7								5
●	2	2.5	3	4	5	6	8		

**SB 351 PG7** Hex fold out holder PocketStar.  
In large PocketStar, 7 pcs.  
Blister packed with hanging hole.

Order-No.	Series								
23041	SB 351 PG7								5
●	2	2.5	3	4	5	6	8		



**351 PK7** Hex fold out holder PocketStar.  
In small PocketStar, 7 pcs.

Blade: Chrome-vanadium steel, through hardened, electro-plated.  
Handle: Ergonomic, reinforced fibreglass housing, 95 mm long.  
Application: Practical fold out holder for hex screws in the workplace or on the job.  
Extra: Robust casing with eject button for simple and easy key selection.

Order-No.	Series							
23035	351 PK7							5
●	1.5	2	2.5	3	4	5	6	

**SB 351 PK7** Hex fold out holder PocketStar.  
In small PocketStar, 7 pcs.  
Blister packed with hanging hole.

Order-No.	Series							
23037	SB 351 PK7							5
●	1.5	2	2.5	3	4	5	6	

# Wiha PocketStar.

Press one button for the correct key.

## Mixed sets.



**351 PG9X** Fold out holder PocketStar containing assorted keys.  
In large PocketStar, 9 pcs.

Blade: Chrome-vanadium steel, through hardened, electro-plated.  
Handle: Ergonomic, reinforced fibreglass housing, 120 mm long.  
Application: Practical fold out holder for hex, slotted, Phillips and TORX® screws in the workplace or on the job.  
Extra: Robust casing with eject button for simple and easy key selection.

Order-No.	Series	
25293	351 PG9X	5
⓪	4.5	
⊕	PH2	
⊛	T10 T15 T20	
⦿	3 4 5 6	

**SB 351 PG9X** Fold out holder PocketStar containing assorted keys.  
In large PocketStar, 9 pcs.  
Blister packed with hanging hole.

Order-No.	Series	
25295	SB 351 PG9X	5



**351 PK6X** Fold out holder PocketStar containing assorted keys.  
In small PocketStar, 6 pcs.

Blade: Chrome-vanadium steel, through hardened, electro-plated.  
Handle: Ergonomic, reinforced fibreglass housing, 95 mm long.  
Application: Practical fold out holder for hex, slotted and Phillips screws in the workplace or on the job.  
Extra: Robust casing with eject button for simple and easy key selection.

Order-No.	Series	
24859	351 PK6X	5
⓪	5.5	
⊕	PH2	
⦿	3 4 5 6	

**SB 351 PK6X** Fold out holder PocketStar containing assorted keys.  
In small PocketStar, 6 pcs.  
Blister packed with hanging hole.

Order-No.	Series	
24861	SB 351 PK6X	5

## For TORX® screws.



**363 P8** TORX® fold out holder PocketStar.  
In large PocketStar, 8 pcs.

Blade: Chrome-vanadium steel, through hardened, electro-plated.  
Handle: Ergonomic, reinforced fibreglass housing, 120 mm long.  
Application: Practical fold out holder for TORX® screws in the workplace or on the job.  
Extra: Robust casing with eject button for simple and easy key selection.

Order-No.	Series	
23047	363 P8	5
⊛	T9 T10 T15 T20 T25 T27 T30 T40	

**SB 363 P8** TORX® fold out holder PocketStar.  
In large PocketStar, 8 pcs.  
Blister packed with hanging hole.

Order-No.	Series	
23049	SB 363 P8	5



**363 P7** TORX® fold out holder PocketStar.  
In small PocketStar, 7 pcs.

Blade: Chrome-vanadium steel, through hardened, electro-plated.  
Handle: Ergonomic, reinforced fibreglass housing, 95 mm long.  
Application: Practical fold out holder for TORX® screws in the workplace or on the job.  
Extra: Robust casing with eject button for simple and easy key selection.

Order-No.	Series	
23051	363 P7	5
⊛	T7 T8 T9 T10 T15 T20 T25	

**SB 363 P7** TORX® fold out holder PocketStar.  
In small PocketStar, 7 pcs.  
Blister packed with hanging hole.

Order-No.	Series	
23053	SB 363 P7	5

## For TORX® Tamper Resistant screws.

**363TR P8** TORX® Tamper Resistant fold out holder PocketStar.  
In large PocketStar, 8 pcs.

Blade: Chrome-vanadium steel, through hardened, electro-plated.  
Handle: Ergonomic, reinforced fibreglass housing, 120 mm long.  
Application: Practical fold out holder for TORX® Tamper Resistant (with security pin) screws in the workplace or on the job.  
Extra: Robust casing with eject button for simple and easy key selection.  
Borehole in every blade tip.

Order-No.	Series	
25130	363TR P8	5
	T9H T10H T15H T20H T25H T27H T30H T40H	

**SB 363TR P8** TORX® Tamper Resistant fold out holder PocketStar.  
In large PocketStar, 8 pcs.  
Blister packed with hanging hole.

Order-No.	Series	
25166	SB 363TR P8	5

**363TR P7** TORX® Tamper Resistant fold out holder PocketStar.  
In small PocketStar, 7 pcs.

Blade: Chrome-vanadium steel, through hardened, electro-plated.  
Handle: Ergonomic, reinforced fibreglass housing, 95 mm long.  
Application: Practical fold out holder for TORX® Tamper Resistant (with security pin) screws in the workplace or on the job.  
Extra: Robust casing with eject button for simple and easy key selection.  
Borehole in every blade tip.

Order-No.	Series	
25128	363TR P7	5
	T7H T8H T9H T10H T15H T20H T25H	

**SB 363TR P7** TORX® Tamper Resistant fold out holder PocketStar.  
In small PocketStar, 7 pcs.  
Blister packed with hanging hole.

Order-No.	Series	
25164	SB 363TR P7	5

## Displays.

**351 PG7 VH1** Display hex fold out holder PocketStar.  
In large PocketStar, 7 pcs.  
Carton display with 10 pieces.

Order-No.	Content		
23502	10 x 351 PG7	2 - 8	1

**351 PG9X VH1** Display fold out holder PocketStar containing assorted keys.  
In large PocketStar, 9 pcs.  
Carton display with 10 pieces.

Order-No.	Content	
25297	10 x 351 PG9X	1

**363 P8 VH1** Display TORX® fold out holder PocketStar.  
In large PocketStar, 8 pcs.  
Carton display with 10 pieces.

Order-No.	Content		
23503	10 x 363 P8	T9 - T40	1

# Wiha Mini PocketStar.

The smallest blade at the push of a button.

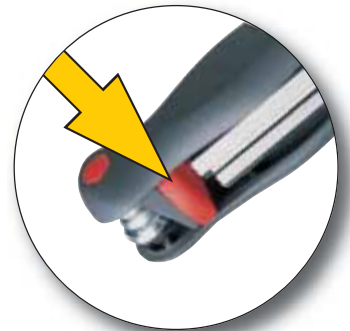

The unique opening mechanism facilitates an easy selection of the desired key size.

Who hasn't spent ages looking for the small SW 0.9 hex key or for other small keys?

Wiha has developed an extremely smart solution to solve exactly this problem: the Mini PocketStar, a small practical helper that is an absolute must in the toolbox of every service and customer-service engineer.

Regardless of whether replacing a proximity switch or pneumatic control unit, or whether adjusting the sensitivity of a light barrier. With the Mini PocketStar, all keys are within reach.



Small but effective. The Mini PocketStar from Wiha is the smart helper for service engineers and for DIY use.



The 180° stop limit when working on applications with higher safety requirements puts an end to trapped fingers.



## Wiha Mini PocketStar.

- All small keys are held together in the Mini PocketStar. Not a single blade is lost
- Each of the 8 blades can be used as screwdriver when set at 180° and as tool with lever arm when set at 90°
- The glass-fibre-reinforced polyamide holder ensures that the Mini PocketStar withstands every stress unscathed
- Of course, the smallest PocketStar also has the same special functions as the "big" PocketStars

### Mixed sets.



**SB 351 PM8X** Hex fold out holder Mini PocketStar.  
With additional blades, 8 pcs.  
Blister packed.

Blade: Chrome-vanadium steel, through hardened, electro-plated.  
Handle: Ergonomic, reinforced fibreglass housing, 55 mm long.  
Application: Practical fold out holder for mini keys so they no longer get lost. Particularly suitable for use with the smallest screws, e.g. when tightening screws or for the accurate setting of sensors.  
Extra: Robust casing with eject button for simple and easy key selection. Hanging loop with matching snap-hook.

Order-No.	Series						
27936	SB 351 PM8X						5
●	0.7 0.9 1.3 1.5 2.0						
⓪	1.5 2.0						
⊕	PH00						

### Mixed sets.



**SB 363 PM8X** TORX® fold out holder Mini PocketStar.  
With additional blades, 8 pcs.  
Blister packed.

Blade: Chrome-vanadium steel, through hardened, electro-plated.  
Handle: Ergonomic, reinforced fibreglass housing, 55 mm long.  
Application: Practical fold out holder for mini keys so they no longer get lost. Particularly suitable for use with the smallest screws, e.g. when tightening screws or for the accurate setting of sensors.  
Extra: Robust casing with eject button for simple and easy key selection. Hanging loop with matching snap-hook.

Order-No.	Series					
27939	SB 363 PM8X					5
⊛	T4 T5 T6 T7					
⓪	1.5 2.0					
⊕	PH00					
●	2.0					



# Wiha ComfortGrip T-handle.

Soft zones for maximum working comfort.



Side blade with through blade.

The new Wiha T-handle with through blade for additional side blade features soft zones for the comfortable transmission of high torques.

Due to their ergonomic design, these handles are comfortable to hold. Fewer pressure points and less strain on the user mean that these tools are a pleasure to use.

When using the side blade, a supporting hand on the handle produces additional stability, which prevents the blade from suddenly slipping out of the screw head. This is better for both blade and screw.

The hole in the handle can be used for shop storage.



No screw can resist. The powerful Wiha ComfortGrip is quick and comfortable to use and even loosens screws that have been glued into position.



A tool that is a pleasure to use. Using the side blade for even greater torque, a supporting hand stabilises the handle and prevents the blade from slipping.



Black soft zones in the handle for comfortable working.



Chrome-plated blade for optimum corrosion protection.



## Wiha ComfortGrip T-handle.

- The integrated side blade is particularly useful when loosening or tightening screws that are rusted-in, glued into position or particularly hard to move
- The through blade withstands even the highest stresses
- Distinctive soft zones on the ergonomic handle for the comfortable transmission of even high torques
- Handle-size concept with three handle shapes designed for maximum ease of use and for applying just the right amount of torque
- The new colour-coding system for the handles couldn't be clearer:  
**Red:** metric hex blades  
**Green:** TORX® profiles

# Wiha ComfortGrip.

Soft zones for maximum working comfort.

For Allen screws (metric).



**540DS** Hexagon ball end screwdriver with ComfortGrip.  
With side blade.

- Blade: Chrome-vanadium steel, through hardened, chrome-plated.  
 Handle: Wiha ComfortGrip, the comfortable multi-component T-handle with soft zones for maximum working comfort.  
 Application: For comfortable high torque transfer. Especially useful for loosening or tightening screws that are hard to move.  
 Specially for hard-to-reach screws.  
 Extra: One piece blade, through the handle withstands even the highest stresses.  
 The ball end enables the user to work at angles up to 25°.

Order-No.	●	↔	↔	↔	↔	↔
28372	3	150	13	80	26	10
28373	4	150	13	80	26	10
28374	5	150	17	100	32	10
28375	6	150	17	100	32	10
28376	8	200	17	100	32	10
28377	10	200	22	120	38	10

For Allen screws (metric).



**334DS** Hex driver with ComfortGrip.  
With side blade.

- Blade: Chrome-vanadium steel, through hardened, chrome-plated.  
 Handle: Wiha ComfortGrip, the comfortable multi-component T-handle with soft zones for maximum working comfort.  
 Application: For comfortable high torque transfer. Especially useful for loosening or tightening screws that are hard to move.  
 Extra: One piece blade, through the handle withstands even the highest stresses.

Order-No.	●	↔	↔	↔	↔	↔
26164	2	100	13	80	26	10
26165	2.5	100	13	80	26	10
26166	3	100	13	80	26	10
26167	4	150	13	80	26	10
26168	5	150	17	100	32	10
26169	6	150	17	100	32	10
26170	8	200	17	100	32	10
26171	10	200	22	120	38	10

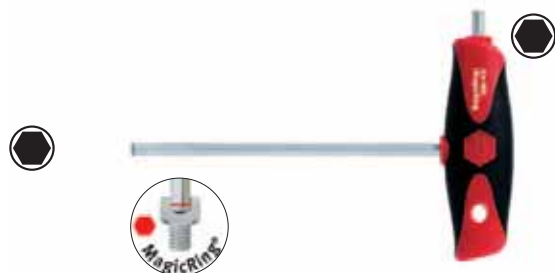

**334DSR** Hex driver with ComfortGrip.  
With MagicRing® and side blade.

- Blade: Chrome-vanadium steel, through hardened, chrome-plated.  
 Handle: Wiha ComfortGrip, the comfortable multi-component T-handle with soft zones for maximum working comfort.  
 Application: For comfortable high torque transfer and to insert and remove screws from holes. Especially useful for loosening or tightening screws that are hard to move.  
 Extra: MagicRing® of spring steel (from size 3 mm) secures all hex standard screws independently of screw material in any position.  
 One piece blade, through the handle withstands even the highest stresses.

Order-No.	●	↔	↔	↔	↔	↔
26135	3	100	13	80	26	10
26136	4	150	13	80	26	10
26137	5	150	17	100	32	10
26138	6	150	17	100	32	10
26139	8	200	17	100	32	10
26140	10	200	22	120	38	10



**334D** Hex driver with ComfortGrip.

- Blade: Chrome vanadium steel, through-hardened, nickel-plated.  
 Handle: Wiha ComfortGrip, the comfortable multi-component T-handle with soft zones for maximum working comfort.  
 Application: For high torque transfer with minimal effort.

Order-No.	●	↔	↔	↔	↔	↔
34664	2	100	126	80	26	10
34665	2.5	100	126	80	26	10
34666	3	100	126	80	26	10
34667	3	150	176	80	26	10
34668	4	100	126	80	26	10
34669	4	150	176	80	26	10
34670	5	100	132	100	32	10
34671	5	150	182	100	32	10
34672	5	200	232	100	32	10
34673	6	100	132	100	32	10
34674	6	150	182	100	32	10
34675	6	200	232	100	32	10
34676	8	150	182	100	32	10
34677	8	200	232	100	32	10
34678	10	200	238	120	38	10

For TORX® screws.



**364DS** TORX® driver with ComfortGrip.  
With side blade.

Blade: Chrome-vanadium steel, through hardened, chrome-plated.  
 Handle: Wiha ComfortGrip, the comfortable multi-component T-handle with soft zones for maximum working comfort.  
 Application: For comfortable high torque transfer. Especially useful for loosening or tightening screws that are hard to move.  
 Extra: One piece blade, through the handle withstands even the highest stresses.  
 ChromTop® blade tip for the highest accuracy at both ends.

Order-No.	⊕	↔	↔	↔	↔	↔
26172	T10	100	13	80	26	10
26173	T15	100	13	80	26	10
26174	T20	100	17	100	32	10
26175	T25	150	17	100	32	10
26176	T27	150	17	100	32	10
26177	T30	150	17	100	32	10
26178	T40	150	17	100	32	10



**364D** TORX® driver with ComfortGrip.

Blade: Chrome-vanadium steel, through hardened, chrome-plated.  
 Handle: Wiha ComfortGrip, the comfortable multi-component T-handle with soft zones for maximum working comfort.  
 Application: For high torque transfer with minimal effort.  
 Extra: ChromTop® blade tip for the highest accuracy.

Order-No.	⊕	↔	↔	↔	↔	↔
34679	T10	100	126	80	26	10
34680	T15	100	126	80	26	10
34681	T20	100	132	100	32	10
34682	T25	100	132	100	32	10
34683	T27	100	132	100	32	10
34684	T30	100	132	100	32	10
34685	T40	100	132	100	32	10

Sets.



**334DS K6** Hex driver set with ComfortGrip, 6 pcs.

Blade: Chrome-vanadium steel, through hardened, chrome-plated.  
 Handle: Wiha ComfortGrip, the comfortable multi-component T-handle with soft zones for maximum working comfort.  
 Application: For comfortable high torque transfer and to insert and remove screws from holes. Especially useful for loosening or tightening screws that are hard to move.  
 Extra: One piece blade, through the handle withstands even the highest stresses.  
 ChromTop® blade tip for the highest accuracy at both ends.  
 6 common sizes in set packaging.

Order-No.	Series	↔
26247	334DS K6	1
●	334DS	2.5 3 4 5 6 8



**364DS K6** TORX® driver set with ComfortGrip, 6 pcs.

Blade: Chrome-vanadium steel, through hardened, chrome-plated.  
 Handle: Wiha ComfortGrip, the comfortable multi-component T-handle with soft zones for maximum working comfort.  
 Application: For comfortable high torque transfer. Especially useful for loosening or tightening screws that are hard to move.  
 Extra: One piece blade, through the handle withstands even the highest stresses.  
 ChromTop® blade tip for the highest accuracy at both ends.  
 6 common sizes in set packaging.

Order-No.	Series	↔
26248	364DS K6	1
●	364DS	T10 T15 T20 T25 T30 T40

# Wiha Classic T-handle.

The classic for high torques.



*The handle design is such that the complete handle surface can be used, thus enabling optimum power transmission.*

The ergonomic design of the Wiha T-handle that fits comfortably into the hand ensures optimum, symmetrical torque transmission from the hand through the blade to the screw. The extruded, angled end of the blade ensures that, even at the highest torques, the blade does not slip but gains a secure hold when either tightening or loosening the screw.

As the blades are subjected to high stresses, Wiha uses exclusively high-quality chrome-vanadium steels that are first subjected to a complex hardening procedure before being used in the wear-resistant blades.



A wide range of hex (metric and inch sizes), TORX® and TORX PLUS® blades, as well as hex drivers (metric and inch), ensures that the perfect tool is at hand for all conceivable applications. A colour-coding system for the handles facilitates the selection of the right blade.



*Thanks to the clear colour-coding system, you're sure to select the appropriate blade.*



## Wiha Classic T-handle.

- High torque transmission thanks to ergonomic handle
- Through hardened blades made of chrome-vanadium steel withstand every stress
- The angled blade end is injection-moulded into the T-handle and non detachable
- Hanging hole for workshop storage
- Made of high-quality plastic

For Allen screws (metric).

For Allen screws (metric).



**334R** Hex driver with T-handle.  
With MagicRing®.

**540** Ball end hex driver with T-handle.

Blade: Chrome-vanadium steel, through hardened, nickel-plated.  
 Handle: Wiha Classic T-handle.  
 Application: For high torque transfer with minimal effort.  
 Extra: MagicRing® of spring steel (from size 3 mm) secures all hex standard screws independently of screw material in any position.

Blade: Chrome-vanadium steel, through hardened, nickel-plated.  
 Handle: Wiha Classic T-handle.  
 Application: For high torque transfer with minimal effort, especially for screws that are difficult to access.  
 Extra: The ball end enables the user to work at angles up to 25°.

Order-No.	●	↔	↔	↔	↔	↔
22168	3	100	126	80	26	10
22170	4	150	176	80	26	10
22172	5	150	182	100	32	10
22174	6	150	182	100	32	10
21960	8	200	232	100	32	10
21962	10	200	238	120	38	10

Order-No.	●	↔	↔	↔	↔	↔
04111	4	150	176	80	26	10
04108	5	150	182	100	32	10
04105	6	150	182	100	32	10
04099	8	200	238	100	32	10
04096	10	200	238	120	38	10



**Wiha Info**

**Wiha MagicRing®.**  
 Thanks to the Wiha MagicRing®, inserting and removing screws is safe and easy, even in areas that are difficult to access.

**334R VB** Hex driver set with T-handle.  
With MagicRing®, in bench stand, 6 pcs.

Blade: Chrome-vanadium steel, through hardened, nickel-plated.  
 Handle: Wiha Classic T-handle.  
 Application: For high torque transfer with minimal effort.  
 Extra: MagicRing® made from spring steel holds all standard screws in every position. Robust metal workbench holder to place on workbench or wall-mount. Tip diagrams printed to scale.

Order-No.	Series	↔			
22096	334R VB	1			
●	334R	3x100	4x150	5x150	
		6x150	8x200	10x200	



# Wiha Classic T-handle.

The classic for high torques.

For Allen screws (metric).



## 334 Hex driver with T-handle.

Blade: Chrome-vanadium steel, through hardened, nickel-plated.  
 Handle: Wiha Classic T-handle.  
 Application: For high torque transfer with minimal effort.

Order-No.	●	↔	⬡	↔	↔	↔	↔
00904	2	100	-	126	80	26	10
00905	2	200	-	226	80	26	10
00906	2.5	100	-	126	80	26	10
00907	2.5	200	-	226	80	26	10
00908	3	100	-	126	80	26	10
00909	3	150	-	176	80	26	10
00910	3	200	-	226	80	26	10
00911	3	350	5+	382	100	32	10
00912	4	100	-	126	80	26	10
00913	4	150	-	176	80	26	10
00914	4	200	-	226	80	26	10
00915	4	350	5+	382	100	32	10
00916	5	100	-	132	100	32	10
00917	5	150	-	182	100	32	10
00918	5	200	-	232	100	32	10
00919	5	350	-	382	100	32	10
00921	6	100	-	132	100	32	10
00922	6	150	-	182	100	32	10
00923	6	200	-	232	100	32	10
00924	6	350	-	382	100	32	10
00926	7	200	-	232	100	32	10
00928	8	100	-	132	100	32	10
00929	8	150	-	182	100	32	10
00930	8	200	-	232	100	32	10
00931	8	350	-	382	100	32	10
00933	10	100	-	138	120	38	10
00934	10	200	-	238	120	38	10
00937	12	200	-	238	120	38	5

+ Overlength with reinforced blade.

For hex nuts.



## 336 Hex nut driver with T-handle.

Blade: Chrome-vanadium steel, through hardened, nickel-plated.  
 Handle: Wiha Classic T-handle.  
 Application: For high torque transfer with minimal effort.  
 Extra: Recess in shank to accommodate for long screws.

Order-No.	○	↔	↔	↔	↔	↔
00965	5.5	125	157	100	32	10
00966	6	125	157	100	32	10
00967	6	200	232	100	32	10
00968	7	125	157	100	32	10
00969	7	200	232	100	32	10
00970	7	350	382	100	32	10
00971	8	125	157	100	32	10
00972	8	200	232	100	32	10
00973	8	350	382	100	32	10
00974	9	125	157	100	32	10
00975	9	200	232	100	32	10
00977	10	125	157	100	32	10
00978	10	200	232	100	32	10
00979	10	230	262	100	32	10
00980	10	350	382	100	32	10
00982	11	125	157	100	32	10
00983	11	230	262	100	32	5
00985	12	125	157	100	32	10
00986	12	230	262	100	32	5
00988	13	125	157	100	32	10
00989	13	230	262	100	32	10
00990	13	350	382	100	32	10
00991	14	125	157	100	32	5
00993	15	125	157	100	32	5
00994	16	125	157	100	32	5
00995	17	125	157	100	32	5



## 334 VB Hex driver set with T-handle. In bench stand, 7 pcs.

Blade: Chrome-vanadium steel, through hardened, nickel-plated.  
 Handle: Wiha Classic T-handle.  
 Application: For high torque transfer with minimal effort.  
 Extra: Robust metal workbench holder to place on workbench or wall-mount.  
 Tip diagrams printed to scale.

Order-No.	Series	↔
00953	334 VB	1
●	334	2x100 2.5x100 3x100 4x150 5x150 6x200 8x200



## 338 Square nut driver with T-handle.

Blade: Chrome-vanadium steel, through hardened, nickel-plated.  
 Handle: Wiha Classic T-handle.  
 Application: For high torque transfer with minimal effort.  
 Extra: Recess in shank to accommodate for long screws.

Order-No.	○	↔	↔	↔	↔	↔
01005	6	125	157	100	32	10
01006	8	125	157	100	32	10
01007	10	125	157	100	32	10
01008	12	125	157	100	32	10

## For hex screws and hex nuts (inch).

**334 Zoll** Hex driver with T-handle.  
Inch sizes.

Blade: Chrome-vanadium steel, through hardened, nickel-plated.

Handle: Wiha Classic T-handle.

Application: For high torque transfer with minimal effort.

Order-No.	⊙	↔	↔	↔	↔	mm	⊖
02802	3/32	150	176	80	26	2.38	10
02803	7/64	150	176	80	26	2.78	10
02804	1/8	150	176	80	26	3.18	10
02805	9/64	150	176	80	26	3.57	10
02806	5/32	150	176	80	26	3.97	10
02807	3/16	150	182	100	32	4.76	10
02808	7/32	150	182	100	32	5.56	10
02809	1/4	150	182	100	32	6.35	10
02810	5/16	150	182	100	32	7.94	10
02811	3/8	150	188	120	38	9.53	10

**336 Zoll** Hex nut driver with T-handle.  
Inch sizes.

Blade: Chrome-vanadium steel, through hardened, nickel-plated.

Handle: Wiha Classic T-handle.

Application: For high torque transfer with minimal effort.

Extra: Recess in shank to accommodate for long screws.

Order-No.	⊙	↔	↔	↔	↔	mm	⊖
02819	3/16	150	182	100	32	4.76	10
02820	1/4	150	182	100	32	6.35	10
02821	5/16	150	182	100	32	7.94	10
02822	3/8	150	182	100	32	9.53	10
02823	7/16	150	182	100	32	11.11	10
02824	1/2	150	182	100	32	12.70	10

## For hex nuts and hex socket screws.

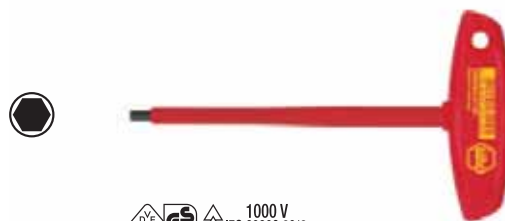

 1000 V  
IEC 60900:2012
**334N** VDE T-handle hex screwdriver.

Individually tested protective insulation 1,000 V AC, VDE and GS tested.

Blade: Chrome-vanadium steel, through hardened, black-finish.

Insulation moulded directly onto blade.

Handle: VDE-insulated T-handle.

Standards: Manufactured acc. to IEC 60900:2012.

Application: For allen screws.

Order-No.	⊙	↔	↔	↔	↔	⊖
27928	4	150	176	80	26	5
27929	5	150	182	100	32	5
27930	6	150	182	100	32	5
27931	8	150	182	100	32	5



 1000 V  
IEC 60900:2012
**336N** VDE T-handle hex nut driver.

Individually tested protective insulation 1,000 V AC, VDE and GS tested.

Blade: Chrome-vanadium steel, through hardened, black-finish.

Insulation moulded directly onto blade. Deep drawn socket.

Handle: VDE-insulated T-handle.

Standards: Manufactured acc. to IEC 60900:2012.

Application: For external hex screws and hex nuts.

Order-No.	⊙	↔	↔	↔	↔	⊖
27932	8	200	232	100	32	5
27933	10	230	262	100	32	5
27934	13	230	262	100	32	5
27935	17	230	268	120	38	5

## Wiha Info

## Colour-coding system:

- red:  
metric hex blades
- yellow:  
inch hex blades
- green:  
TORX® blades
- light green:  
TORX PLUS® blades

# Wiha Classic T-handle.

The classic for high torques.

For TORX® screws.



## 364 TORX® driver with T-handle.

Blade: Chrome-vanadium steel, through hardened, chrome-plated.  
 Handle: Wiha Classic T-handle.  
 Application: For high torque transfer with minimal effort.  
 Extra: ChromTop® blade tip for the highest accuracy.

Order-No.	⊛	↔	●	↔	↔	↔	↔
01328	T9	100	4.0	126	80	26	10
01329	T10	100	4.0	126	80	26	10
01330	T15	100	4.0	126	80	26	10
01331	T15	200	5.5	226	80	26	10
01332	T20	100	4.0	132	100	32	10
01333	T20	200	5.5	232	100	32	10
01334	T25	100	4.5	132	100	32	10
01335	T25	200	5.5	232	100	32	10
01336	T27	100	5.5	132	100	32	10
01337	T27	200	5.5	232	100	32	10
01338	T30	100	6.0	132	100	32	10
01339	T30	200	6.0	232	100	32	10
01340	T40	100	7.0	132	100	32	10
01341	T40	200	7.0	232	100	32	10
01343	T45	250	8.0	288	120	38	10
01345	T50	250	9.0	288	120	38	10



## 364 VB TORX® driver set with T-handle. In bench stand, 7 pcs.

Blade: Chrome-vanadium steel, through hardened, chrome-plated.  
 Handle: Wiha Classic T-handle.  
 Application: For high torque transfer with minimal effort.  
 Extra: ChromTop® blade tip for the highest accuracy.  
 Robust metal workbench holder to place on workbench or wall-mount.  
 Tip diagrams printed to scale.

Order-No.	Series	↔				
01348	364 VB	1				
⊛	364	T10x100	T15x100	T20x100		
		T25x100	T30x100	T40x200	T50x250	

For TORX® and TORX PLUS® screws.



## 364R TORX® driver with T-handle. With MagicSpring®.

Blade: Chrome-vanadium steel, through hardened, chrome-plated.  
 Handle: Wiha Classic T-handle.  
 Application: For high torque transfer with minimal effort.  
 Extra: MagicSpring® made of stainless steel holds TORX® screws tight at various angles. ChromTop® blade tip for the highest accuracy. Blade made of hexagonal material is particularly capable of withstanding stress.

Order-No.	⊛	↔	●	↔	↔	↔	↔
27964	T9	100	4.0	126	80	26	10
27965	T10	100	4.0	126	80	26	10
27966	T15	100	4.0	126	80	26	10
27967	T20	100	4.0	132	100	32	10
27968	T25	100	5.0	132	100	32	10
27969	T27	100	6.0	132	100	32	10
27970	T30	100	6.0	132	100	32	10
27971	T40	100	8.0	132	100	32	10



## 364IP TORX PLUS® driver with T-handle.

Blade: Chrome-vanadium steel, through hardened, chrome-plated.  
 Handle: Wiha Classic T-handle.  
 Application: For high torque transfer with minimal effort.  
 Extra: The stronger profile of the TORX PLUS® tip allows up to 25% extra torque than the TORX® profile.  
 ChromTop® blade tip for the highest accuracy.  
**Attention: TORX PLUS® keys cannot be used with TORX® screws.**

Order-No.	⊛	↔	●	↔	↔	↔	↔
26953	9IP	100	4.0	126	80	26	10
26954	10IP	100	4.0	126	80	26	10
26955	15IP	100	4.0	126	80	26	10
26956	20IP	100	4.0	132	100	32	10
26957	25IP	150	4.5	182	100	32	10
26958	27IP	150	5.5	182	100	32	10
26959	30IP	150	6.0	182	100	32	10
26960	40IP	150	7.0	182	100	32	10

# Wiha flag and key handle.

The knack of applying just the right amount of pressure.



*Innovative torsion blade in sizes T5 to T10 does not damage the expensive fastening screws or the tool profile.*

Screwdrivers with flag or key handles are used whenever replacing indexable inserts on milling heads.

Thanks to the large support area for thumb and index finger, it is possible to loosen or tighten any screw with comfort by applying just the right amount of pressure. These tools are also particularly suitable for high-torque adjustment work.



*The small, 7-piece bench stand ensures a tidy working environment.*



*The flag and key handles have large support surfaces for thumb and index finger for ease of use and efficiency.*



**Wiha flag and key handle.**

- Large support areas for thumb and index finger on the ergonomically shaped handles. The transmission of high torques is thus quite simple
- Cylindrical handle shaft for quick turning of screws
- Innovative torsion blade for T5 to T10 greatly reduces the risk of breakage. Thus, broken profiles in the screw head are largely avoided. If more torque than required is applied, the blade responds elastically (cf. picture)
- Thanks to thin blades, even covered screws in the screw axis can be turned

# Wiha key handle.

For Allen screws and TORX® screws.



## 331 Hex driver with key handle.

Blade: Chrome-vanadium steel, through hardened, black-finish.  
 Handle: Wiha key handle.  
 Application: For high torque transfer with small screws, especially when replacing indexable inserts on milling heads.

Order-No.	●	↔	↔	↔	↔
00894	1.5	60	95	40	10
00895	2	60	95	40	10
00896	2.5	60	95	40	10
00897	3	60	95	40	10



## 365 TORX® driver with key handle.

Blade: Chrome-vanadium steel, through hardened, black-finish.  
 Handle: Wiha key handle.  
 Application: For high torque transfer with small screws, especially when replacing indexable inserts on milling heads.

Order-No.	●	↔	●	↔	↔	↔
04918	T5	35	2.0	70	40	10
01350	T6	35	2.0	70	40	10
01351	T7	35	2.5	70	40	10
01352	T8	40	2.5	75	40	10
01353	T9	40	3.0	75	40	10
01354	T10	40	3.0	75	40	10
01355	T15	45	3.5	80	40	10
01356	T20	45	4.0	80	40	10



## 365 VB TORX® screwdriver set with key handle. In small bench stand, 7 pcs.

Blade: Chrome-vanadium steel, through hardened, black-finish.  
 Handle: Wiha key handle.  
 Application: For high torque transfer with small screws, especially when replacing indexable inserts on milling heads.  
 Extra: Small, robust metal workbench holder to stand on workbench. Tip diagrams printed to scale.

Order-No.	Series					
25624	365 VB	1				
●	365	T6x35	T7x35	T8x40		
		T9x40	T10x40	T15x45	T20x45	

For TORX PLUS® screws.



## 365IP TORX PLUS® driver with key handle.

Blade: Chrome-vanadium steel, through hardened, black-finish.  
 Handle: Wiha key handle.  
 Application: For high torque transfer with small screws, especially when replacing indexable inserts on milling heads.  
 Extra: The stronger profile of the TORX PLUS® tip allows up to 25% extra torque than the TORX® profile.

Attention: TORX PLUS® keys cannot be used with TORX® screws.

Order-No.	●	↔	●	↔	↔	↔
26181	5IP	35	2.0	70	40	10
26182	6IP	35	2.0	70	40	10
26183	7IP	35	2.5	70	40	10
26184	8IP	40	2.5	75	40	10
26185	9IP	40	3.0	75	40	10
26186	10IP	40	3.0	75	40	10
26187	15IP	45	3.5	80	40	10
26188	20IP	45	4.0	80	40	10



## 365IP VB TORX PLUS® driver set with key handle. In small bench stand, 7 pcs.

Blade: Chrome-vanadium steel, through hardened, black-finish.  
 Handle: Wiha key handle.  
 Application: For high torque transfer with small screws, especially when replacing indexable inserts on milling heads.  
 Extra: Small, robust metal workbench holder to stand on workbench. Tip diagrams printed to scale.

Order-No.	Series					
26261	365IP VB	1				
●	365IP	6IPx35	7IPx35	8IPx40		
		9IPx40	10IPx40	15IPx45	20IPx45	

### Wiha Info

#### Colour-coding system:

- **red:**  
metric hex blades
- **yellow:**  
inch hex blades
- **green:**  
TORX® blades
- **light green:**  
TORX PLUS® blades



# Wiha flag handle and offset screwdrivers.

For TORX® and TORX PLUS® screws.



## 370 TORX® driver with flag handle.

Blade: Chrome-vanadium steel, through hardened, black-finish.

Handle: Wiha flag handle.

Application: For high torque transfer with small screws, especially when replacing indexable inserts on milling heads.

Order-No.	⊗	↔	●	↔	↔	↔
03724	T5	35	2.0	62	15	10
03725	T6	35	2.0	62	15	10
03726	T7	35	2.5	67	19	10
03727	T8	40	2.5	72	19	10
03728	T9	40	3.0	74	24	10
03729	T10	40	3.0	74	24	10
03730	T15	45	3.5	80	28	10
03731	T20	45	4.0	80	28	10



## 370 VB TORX® driver set with flag handle. In small bench stand, 7 pcs.

Order-No.	Series	↔
25625	370 VB	1
⊗	370	
	T6x35	T7x35
	T8x40	T9x40
	T10x40	T15x45
	T20x45	



## 370IP TORX PLUS® driver with flag handle.

Blade: Chrome-vanadium steel, through hardened, black-finish.

Handle: Wiha flag handle.

Application: For high torque transfer with small screws, especially when replacing indexable inserts on milling heads.

Extra: The stronger profile of the TORX PLUS® tip allows up to 25% extra torque than the TORX® profile.

Attention: TORX PLUS® keys cannot be used with TORX® screws.

Order-No.	⊗	↔	●	↔	↔	↔
27614	5IP	35	2.0	67	15	10
27615	6IP	35	2.0	67	15	10
27616	7IP	35	2.5	67	19	10
27617	8IP	40	2.5	72	19	10
27618	9IP	40	3.0	74	24	10
27619	10IP	40	3.0	74	24	10
27620	15IP	45	3.5	80	28	10
27621	20IP	45	4.0	80	28	10

For slotted, Phillips and Pozidriv screws.



## 207 Slotted offset screwdriver with handle.

Blade: Chrome-vanadium steel, through hardened, chrome-plated.

Standards: DIN 5200.

Application: For working in confined spaces.

Order-No.	⊕	⊖	↔	↔	●	↔
00373	3.5	0.6	90	8.5	3.5	10
00374	4.0	0.8	100	9.0	4.0	10
00375	5.5	1.0	125	10.5	5.5	10
00376	6.5•	1.2	125	13.5	6.5	10
00377	8.0	1.2	150	17.0	8.0	10
00378	10.0	1.6	175	24.0	9.0	10
00379	12.0	2.0	200	27.0	10.0	5

• Additional dimension. Non-DIN size.

NEW

## SB 207 Slotted offset screwdriver with handle. Blister packed.

Order-No.	⊕	⊖	↔	↔	●	↔
04451	5.5	1.0	125	10.5	5.5	1



## 161 Phillips offset screwdriver with handle.

Blade: Chrome-vanadium steel, through hardened, chrome-plated.

Standards: DIN 5208.

Application: For working in confined spaces.

Order-No.	⊕	⊕	↔	↔	●	↔
00144	PH1	PH2	125	14.5	5.5	10
00145	PH2	PH3	150	21.0	8.0	10
00146	PH3	PH4	200	25.0	10.0	10

NEW

## SB 161 Phillips offset screwdriver with handle. Blister packed.

Order-No.	⊕	⊕	↔	↔	●	↔
04454	PH1	PH2	125	14.5	5.5	1
04455	PH2	PH3	150	21	8	1



## 224 Pozidriv offset screwdriver with handle.

Blade: Chrome-vanadium steel, through hardened, black-finish.

Standards: DIN 5208.



















Application: For working in confined spaces.

Order-No.	⊕	⊕	↔	↔	●	↔
00432	PZ1	PZ2	125	14.5	5.5	10
00433	PZ2	PZ3	150	21.0	8.0	10
00434	PZ3	PZ4	200	25.0	10.0	10



















# Wiha bits.

Wiha makes it possible: Professional technology for any application.



	 Slotted	 Phillips PH	 Xeno SL/PH	 Pozidriv PZ	 Xeno SL/PZ	 TORX®	 TORX® Tamper Resistant	 TORX PLUS®	 Hex	 Square	 Multi-tooth	 Tri-Wing® + Torq-Set®	 SIT + Spanner	
<b>MaxxTor-Bits</b>		177		177		177			177	177				
<b>DuraBits®</b>	179	179		179		179								
<b>Diamond bit</b>	181	181		181		181								
<b>Torsion bits</b>	183/185	183/185		183/185		183/185						186		
<b>Inkra bits</b>		187		187										
<b>Standard bits</b>	189	189		189		190	190	190	191	192	192		192	
<b>Stainless steel bits</b>	193	193		193		193								
<b>Professional bits</b>	195	195	195	195	195	196	196	196	196	197				
<b>Industrial bits</b>		199				199		199	199	199				
<b>Bits with MagicRing®</b>										198				
<b>Threaded bits</b>		200		200		200								
<b>Drive system C4</b>	202	202				202				202				
<b>Drive system C 8 5/16"</b>	204	204		204		204				204				
<b>Drive system G 7</b>		204		204										
	 Wood twist drill	 Twist drill	 Universal drill	 Combination drill	 Counter-sink									
<b>Drill bits</b>	206	206	207	207	207									

## Bits assortment

	<b>Wiha MaxxTor bits.</b> Maximum lifespan – Maximum torsion.....	176 – 177
	<b>Wiha DuraBit.</b> A diamond among bits.....	178 – 179
	<b>Wiha diamond bit.</b> Saves strength, time & money.....	180 – 181
	<b>Wiha Torsion bit.</b> Patented torsion zone for longer service life.....	182 – 186
	<b>Wiha Inkra bit.</b> The specialist for every angle.....	187
	<b>Wiha Standard bit.</b> Full programme range in outstanding quality.....	188 – 192
	<b>Wiha Stainless steel bit.</b> Precision-fitting, powerful and durable.....	193
	<b>Wiha Professional bits.</b> Wiha Professional bits - everything but standard.....	194 – 198
	<b>Wiha Industrial bits.</b> Specialists for series connections.....	199
	<b>Wiha special bits.</b> Customised for your application.....	201
	<b>Wiha CentroFix system.</b> Quick and professional.....	205
	<b>Wiha Kraft-Steckschlüssel-Programm.</b> The entire line for hand and machine use.....	208 – 211
	<b>Wiha bit holder.</b> For rapid changing of bits without tools.....	215 – 217
	<b>Wiha magazine bit holder.</b> Everything in the palm of your hand.....	220
	<b>Wiha magazine bit holder.</b> Maximum efficiency by direct insert of bits.....	228 – 233
	<b>Wiha XSelector and XLSelector.</b> Couldn't be smaller!.....	234 – 243
	<b>Wiha Collector.</b> Everything in one box.....	244 – 245
	<b>Wiha SB bit programme.</b> Full programme range in outstanding quality.....	248 – 253

# Wiha MaxxTor bits.

Maximum lifespan – Maximum torsion.



product design award

2013



reddot design award winner 2013



Focus Open 2013 Silver

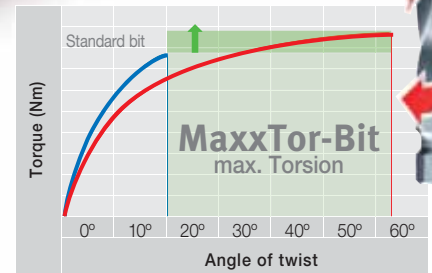

High-performance drill and impact screwdrivers place tough demands on bits, for example via changing loads with impact screwdrivers or especially tough fastenings.

Standard bits are quickly unable to meet the challenge.

But not Maxx-Tor bits! With their optimised torsion zone, the lifespan of the bits is significantly increased.



## 29er MaxxTor bits The ultimate torsion bit

\* Double lifespan: Compared to other high-performance impact bits, Wiha MaxxTor T25x29 achieves twice as many load changes in testing. The load changes simulate the number of completed fastenings before breakage.

\* Triple lifespan compared to common standard bits.

## 49er MaxxTor bits The ultimate impact bit

\* 70% longer lifespan compared to the best T25x50 high-performance impact bits on the market.

• Ideal for continuous impact use



## Wiha MaxxTor bits.

- Maximum service life thanks to maximum torsion zone
- Plastic sheath improves torsion properties, enables clamping in the BitBuddy
- Ideal for high-performance drills and impact screwdrivers
- Full assortment: PH, PZ, TORX®, hex, Robertson



MaxxLifetime

\* Research and Testing Centre results  
Information refers to comparative test of competing T25 bits conducted by the renowned, independent German testing institute:  
VPA Versuchs- und Prüfanstalt Zertifizierung GmbH / Remscheid | 7/2012 (Remscheid Research and Testing Centre, Germany)

## The 2-component bit.

### 29er® MaxxTor bit.



#### 7011 M9T 29er® MaxxTor bit, Phillips, 1/4" hex.

**Material:** High quality alloyed tool steel, optimally hardened.  
Casing of transparent, impact resistant plastic.

**Geometry:** Maximum torsion zone – optimised and adapted for any output.  
Precision-milled profile for perfect fit and maximum performance.

**Drive:** 1/4" hex, combination drive for bit holder in accordance with DIN 3126, ISO 1173 style D 6.3 and F 6.3.

**Application:** Ideally suited for high-performance drill and impact screwdrivers

**Extra:** Plus 4 mm length.  
Additional range, easier handling when changing the bit.  
Two-component construction – Plastic coating for improved torsion properties, increased work safety, facilitates clamping in the BitBuddy®.  
Practical laser marking for easy identification of size.

Order-No.	+	↔	▬
38203	PH1	29	10
38204	PH2	29	10
38205	PH3	29	10



#### 7012 M9T 29er® MaxxTor bit, Pozidriv, 1/4" hex.

Order-No.	+	↔	▬
38206	PZ1	29	10
38207	PZ2	29	10
38208	PZ3	29	10



#### 7015 M9T 29er® MaxxTor bit, TORX®, 1/4" hex.

Order-No.	+	↔	▬
38213	T10	29	10
38214	T15	29	10
38215	T20	29	10
38216	T25	29	10
38438	T27	29	10
38217	T30	29	10
38218	T40	29	10



#### 7013 M9T 29er® MaxxTor bit, hex, 1/4" hex.

Order-No.	●	↔	▬
38209	3.0	29	10
38210	4.0	29	10
38211	5.0	29	10
38212	6.0	29	10
39161	1/8"	29 NEW	10
39165	9/64"	29 NEW	10
39163	5/32"	29 NEW	10
39162	3/16"	29 NEW	10
39164	7/32"	29 NEW	10
39160	1/4"	29 NEW	10



**NEW**

#### 7018 M9T 29er® MaxxTor bit, Robertson, 1/4" hex.

Order-No.	■	↔	▬
39172	Robertson 1	2.3 29	10
39173	Robertson 2	2.8 29	10
39174	Robertson 3	3.3 29	10

### 49 series MaxxTor bit.



#### 7041 M9T 49er MaxxTor bit, Phillips, style E 6.3.

**Geometry:** Extremely long torsion zone individually matched to the profile.  
Precision-milled profile for perfect fit and maximum performance.

**Drive:** DIN 3126, ISO 1173, style E 6.3.

**Anwendung:** Ideally suited for high-performance drill and impact screwdriver

Order-No.	+	↔	▬
38219	PH1	49	5
38220	PH2	49	5
38221	PH3	49	5



#### 7042 M9T 49er MaxxTor bit, Pozidriv, style E 6.3.

Order-No.	+	↔	▬
38222	PZ1	49	5
38223	PZ2	49	5
38224	PZ3	49	5



#### 7045 M9T 49er MaxxTor bit, TORX®, style E 6.3.

Order-No.	+	↔	▬
38229	T10	49	5
38230	T15	49	5
38231	T20	49	5
38232	T25	49	5
38439	T27	49	5
38233	T30	49	5
38234	T40	49	5



#### 7043 M9T 49er MaxxTor bit, hex, style E 6.3.

Order-No.	●	↔	▬
38225	3.0	49	5
38226	4.0	49	5
38227	5.0	49	5
38228	6.0	49	5
39167	1/8"	49 NEW	5
39171	9/64"	49 NEW	5
39169	5/32"	49 NEW	5
39168	3/16"	49 NEW	5
39170	7/32"	49 NEW	5
39166	1/4"	49 NEW	5



**NEW**

#### 7048 M9T 49er MaxxTor bit, Robertson, style E 6.3.

Order-No.	■	↔	▬
39175	Robertson 1	2.3 49	5
39176	Robertson 2	2.8 49	5
39177	Robertson 3	3.3 49	5



# Wiha DuraBit.

A diamond among bits.



*The extremely wear-resistant hard-metal coating considerably increases tool life.*

With DuraBit, Wiha puts its innovative strength to the test. The tough torsion bit has an extremely wear-resistant hard-metal coating that gains a secure hold in the screw head.

This revolutionary coating technology originates from the aerospace industry and guarantees outstanding gripping of the bit surface. The user quickly comes to appreciate the benefits: a longer tool life, much reduced cam-out effects and superior handling enable efficient work, even with the most difficult of applications.

The wolfram carbide particles are permanently applied to the bit tip - a breaking away of the particles (as occurs with conventional, diamond-coated bits) is therefore significantly reduced.



*The Dura coating reduces CamOut effects to an unbeatable minimum - no more slipping out of the bit from the screw head.*

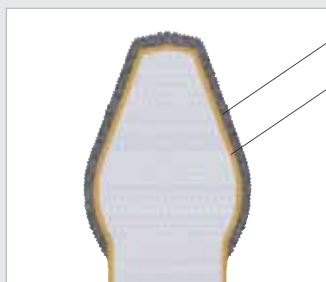

*Wolfram carbide particles.*

*Non-corroding nickel coating.*

*Long-lasting, durable wolfram carbide coating increases service life of the bit by many times when compared to a diamond-coated bit. The subjacent nickel coating ensures extra-long corrosion resistance.*



## Wiha DuraBit.

- Extremely wear-resistant hard-metal coating also used in the aerospace industry gains a secure hold in the screw head. Outstanding reduction of CamOut forces prevents slipping out of the bit
- Wolfram carbide particles guarantee a significantly greater service life when compared to conventional diamond-coated bits
- Nickel coating of the entire bit for extra-long corrosion resistance
- Clear reduction in the cam-out effect (slipping of the bit out of the screw head) for:
  - Fatigue-free work (less force required)
  - Less wear of bit and screw
  - Safe work on delicate surfaces
- Work with Wiha DuraBits featuring torsion zones reduces the amount of time for fastening and enables economic and safe work

## Style C 6.3 (1/4").

**7010 DR** DuraBit with torsion zone, slotted, style C 6.3.

Material: High grade chrome-vanadium steel, through hardened.

Geometry: Torsion zone for protecting against premature breakage of bits under load.

Coating: Hard-metal coating, extremely wear-resistant.

Drive: DIN 3126, ISO 1173, style C 6.3.

Application: For effortless, safe working in demanding industrial applications and on delicate surfaces.

Extra: Non-corroding nickel coating in combination with wolfram carbide particles.

Extremely wear-resistant, hard-metal coated DuraBit tip gains a secure hold in the screw head and guarantees a significantly greater service life when compared to conventional diamond-coated bits.

Outstanding reduction of CamOut forces prevents slipping out of the bit from the screw.

Order-No.	⊖	↔	⊖	▬
23104	4.5	25	0.6	10
23106	5.5	25	0.8	10
23110	6.5	25	1.2	10

## Style C 6.3 and E 6.3 (1/4").

**7041 DR** DuraBit with torsion zone, Phillips, style E 6.3.

Material: High grade chrome-vanadium steel, through hardened.

Geometry: Patented torsion zone to prevent premature breaking of the bit when under stress.

Coating: Hard-metal coating, extremely wear-resistant.

Drive: DIN 3126, ISO 1173, style E 6.3.

Application: For effortless, safe working in demanding industrial applications and on delicate surfaces.

Extra: Non-corroding nickel coating in combination with wolfram carbide particles.

Extremely wear-resistant, hard-metal coated DuraBit tip gains a secure hold in the screw head and guarantees a significantly greater service life when compared to conventional diamond-coated bits.

Outstanding reduction of CamOut forces prevents slipping out of the bit from the screw.

Order-No.	⊕	↔	▬
23388	PH1	50	5
23390	PH2	50	5
23392	PH3	50	5

**7011 DR** DuraBit with torsion zone, Phillips, style C 6.3.

Order-No.	⊕	↔	▬
23114	PH1	25	10
23116	PH2	25	10
23118	PH3	25	10

**7042 DR** DuraBit with torsion zone, Pozidriv, style E 6.3.

Material: High grade chrome-vanadium steel, through hardened.

Geometry: Patented torsion zone to prevent premature breaking of the bit when under stress.

Coating: Hard-metal coating, extremely wear-resistant.

Drive: DIN 3126, ISO 1173, style E 6.3.

Application: For effortless, safe working in demanding industrial applications and on delicate surfaces.

Extra: Non-corroding nickel coating in combination with wolfram carbide particles.

Extremely wear-resistant, hard-metal coated DuraBit tip gains a secure hold in the screw head and guarantees a significantly greater service life when compared to conventional diamond-coated bits.

Outstanding reduction of CamOut forces prevents slipping out of the bit from the screw.

Order-No.	⊕	↔	▬
23394	PZ1	50	5
23396	PZ2	50	5
23398	PZ3	50	5

**7012 DR** DuraBit with torsion zone, Pozidriv, style C 6.3.

Order-No.	⊕	↔	▬
23120	PZ1	25	10
23122	PZ2	25	10
23124	PZ3	25	10

**7015 DR** DuraBit with torsion zone, TORX®, style C 6.3.

Order-No.	⊗	↔	▬
23133	T10	25	10
23135	T15	25	10
23137	T20	25	10
23139	T25	25	10
23141	T30	25	10
23143	T40	25	10

# Wiha diamond bit.

Saves strength, time & money.



*Finest diamond particles and sapphire particles ensure a firm grip a thousand times over.*

Diamond torsion bits supplement Wiha's range of high-quality special bits. In the area of mechanical fastening the significantly greater tool life means substantial cost reductions.

The new Wiha diamond torsion bits are recognisable by their silver look and striking black tip and offer an impressively secure grip in the screw.



*The Diamond torsion bit from Wiha scores on two accounts: it reduces the amount of pressure that has to be applied and increases the tool life.*

*The torsion zone protects against torque peaks.*



## Wiha diamond bit.

- Reduction of:
  - Pressure forces to be applied
  - Wear and tear of bit and screw head
  - The amount of time to turn the screw and thus reduction in the costs of screw applications
  - Cam-out effect
- Extended service life as a result of the improved torsion zone
- Nickel coating of the entire bit for long-lasting corrosion resistance

## Style C 6.3 (1/4").

**7010 D** Diamond torsion bit, slotted, style C 6.3.

Material: High grade chrome-vanadium steel, through hardened.  
 Geometry: Torsion zone for protecting against premature breakage of bits under load.  
 Coating: Extremely wear-resistant diamond-sapphire coating with a long service life.  
 Drive: DIN 3126, ISO 1173, style C 6.3.  
 Application: For fatigue-free work; ideal bit for frequent working.  
 Extra: Non-corrosive coating.  
 Diamond particles and sapphire particles for optimum torque transfer and a secure grip in the screw head.

Order-No.	⌀	↔	⊖	↔
21272	4.5	25	0.6	10
21216	5.5	25	0.8	10
21220	6.5	25	1.2	10

## Style C 6.3 and E 6.3 (1/4").

**7015 D** Diamond torsion bit, TORX®, style C 6.3.

Material: High grade chrome-vanadium steel, through hardened.  
 Geometry: Torsion zone for protecting against premature breakage of bits under load.  
 Coating: Extremely wear-resistant diamond-sapphire coating with a long service life.  
 Drive: DIN 3126, ISO 1173, style C 6.3.  
 Application: For fatigue-free work; ideal bit for frequent working.  
 Extra: Non-corrosive coating.  
 Diamond particles and sapphire particles for optimum torque transfer and a secure grip in the screw head.

Order-No.	⊕	↔	↔
21204	T10	25	10
21206	T15	25	10
21208	T20	25	10
21210	T25	25	10
21212	T30	25	10
21214	T40	25	10

**7011 D** Diamond torsion bit, Phillips, style C 6.3.

Material: High grade chrome-vanadium steel, through hardened.  
 Geometry: Patented torsion zone to prevent premature breaking of the bit when under stress.  
 Coating: Extremely wear-resistant diamond-sapphire coating with a long service life.  
 Drive: DIN 3126, ISO 1173, style C 6.3.  
 Application: For fatigue-free work; ideal bit for frequent working.  
 Extra: Non-corrosive coating.  
 Diamond particles and sapphire particles for optimum torque transfer and a secure grip in the screw head.

Order-No.	⊕	↔	↔
21193	PH1	25	10
21194	PH2	25	10
21196	PH3	25	10

**7041 D** Diamond torsion bit, Phillips, style E 6.3.

Material: High grade chrome-vanadium steel, through hardened.  
 Geometry: Patented torsion zone to prevent premature breaking of the bit when under stress.  
 Coating: Extremely wear-resistant diamond-sapphire coating with a long service life.  
 Drive: DIN 3126, ISO 1173, style E 6.3.  
 Application: For fatigue-free work; ideal bit for frequent working.  
 Extra: Non-corrosive coating.  
 Diamond particles and sapphire particles for optimum torque transfer and a secure grip in the screw head.

Order-No.	⊕	↔	↔
23376	PH1	50	5
23378	PH2	50	5
23380	PH3	50	5

**7012 D** Diamond torsion bit, Pozidriv, style C 6.3.

Material: High grade chrome-vanadium steel, through hardened.  
 Geometry: Patented torsion zone to prevent premature breaking of the bit when under stress.  
 Coating: Extremely wear-resistant diamond-sapphire coating with a long service life.  
 Drive: DIN 3126, ISO 1173, style C 6.3.  
 Application: For fatigue-free work; ideal bit for frequent working.  
 Extra: Non-corrosive coating.  
 Diamond particles and sapphire particles for optimum torque transfer and a secure grip in the screw head.

Order-No.	⊕	↔	↔
21198	PZ1	25	10
21200	PZ2	25	10
21202	PZ3	25	10

**7042 D** Diamond torsion bit, Pozidriv, style E 6.3.

Material: High grade chrome-vanadium steel, through hardened.  
 Geometry: Patented torsion zone to prevent premature breaking of the bit when under stress.  
 Coating: Extremely wear-resistant diamond-sapphire coating with a long service life.  
 Drive: DIN 3126, ISO 1173, style E 6.3.  
 Application: For fatigue-free work; ideal bit for frequent working.  
 Extra: Non-corrosive coating.  
 Diamond particles and sapphire particles for optimum torque transfer and a secure grip in the screw head.

Order-No.	⊕	↔	↔
23382	PZ1	50	5
23384	PZ2	50	5
23386	PZ3	50	5

# Wiha Torsion bit.

Patented torsion zone for longer service life.

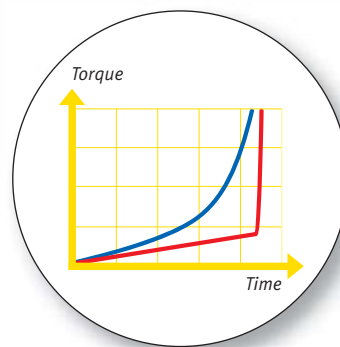

The red line indicates the steep increase in torque with hard applications, e.g. in metal.

The blue line shows a steady torque increase in soft applications, e.g. in wood working.



## Wiha Torsion bit.

The main cause of wear with soft fastening applications such as in wood for example is the wear of the profile edges because the bit rattles through. A hard bit needs to be used here: Wiha HOT.

With hard fastening jobs such as hitting metal surfaces the main reason for wear is breakage of the bits. These usually occur with torque peaks near to the end of the fastening process. A tough-but-flexible bit is the answer: Wiha ZOT.

The special assortment of Wiha torsion bits with torsion zones offers optimal products for both soft and hard fastening tasks.

### Wiha ZOT Torsion bits

- Tough, hard Torsion quality for **hard applications**
- Ideal for screw applications in metal and hard materials
- Elastic Torsion zone absorbs the strong torque peaks in the final phase of the application (red line)
- Highly resistant to wear and tear due to special heat treatment
- Hardness 61-2 HRC.
- For trade and DIY

### Wiha HOT Torsion bits

- Extra hard Torsion quality for **soft applications**
- Ideal for screw applications in wood and soft materials
- Average requirements concerning elasticity are used to optimise performance and resistance to wear and tear (blue line)
- Hardness 63-2 HRC.
- For trade and DIY

### Wiha TiN Torsions bits

- Tough, hard Torsion quality with very hard **titanium-nitride (TiN)** coating
- Optimum resistance to wear and tear due to very hard TiN coating
- Combines the advantages of Wiha HOT bits and ZOT bits in one outstanding bit
- For trade and DIY, especially for industry



## Style C 6.3 (1/4").

**7010 TiN** TiN Torsion bit, slotted, style C 6.3.

Material: High grade chrome-vanadium steel, through hardened.  
 Geometry: Torsion zone for protecting against premature breakage of bits under load.  
 Coating: Titanium nitride for extended tool life.  
 Drive: DIN 3126, ISO 1173, style C 6.3.  
 Application: Particularly suitable for screws that require frequent working.

Order-No.	⊖	↔	⊖	☰
04743	4.5	25	0.6	10
04744	5.5	25	0.8	10
04745	6.5	25	1.2	10
04746	8.0	25	1.2	10

## Style E 6.3 (1/4").

**7041 TiN** TiN Torsion bit, Phillips, style E 6.3.

Material: High grade chrome-vanadium steel, through hardened.  
 Geometry: Patented torsion zone to prevent premature breaking of the bit when under stress.  
 Coating: Titanium nitride for extended tool life.  
 Drive: DIN 3126, ISO 1173, style E 6.3.  
 Application: Particularly suitable for screws that require frequent working.

Order-No.	⊕	↔	☰
04861	PH1	50	5
04862	PH2	50	5
04863	PH3	50	5

**7011 TiN** TiN Torsion bit, Phillips, style C 6.3.

Material: Patented torsion zone to prevent premature breaking of the bit when under stress.  
 Coating: DIN 3126, ISO 1173, style C 6.3.

Order-No.	⊕	↔	☰
04654	PH1	25	10
04655	PH2	25	10
04656	PH3	25	10

**7042 TiN** TiN Torsion bit, Pozidriv, style E 6.3.

Material: High grade chrome-vanadium steel, through hardened.  
 Geometry: Patented torsion zone to prevent premature breaking of the bit when under stress.  
 Coating: Titanium nitride for extended tool life.  
 Drive: DIN 3126, ISO 1173, style E 6.3.  
 Application: Particularly suitable for screws that require frequent working.

Order-No.	⊕	↔	☰
04864	PZ1	50	5
04865	PZ2	50	5
04866	PZ3	50	5

**7012 TiN** TiN Torsion bit, Pozidriv, style C 6.3.

Material: Patented torsion zone to prevent premature breaking of the bit when under stress.  
 Coating: DIN 3126, ISO 1173, style C 6.3.

Order-No.	⊕	↔	☰
04657	PZ1	25	10
04658	PZ2	25	10
04659	PZ3	25	10

**7015 TiN** TiN Torsion bit, TORX®, style C 6.3.

Material: Torsion zone for protecting against premature breakage of bits under load.  
 Coating: DIN 3126, ISO 1173, style C 6.3.

Order-No.	⊛	↔	☰
20964	T6	25	10
20966	T7	25	10
20968	T8	25	10
20970	T9	25	10
20972	T10	25	10
20974	T15	25	10
20976	T20	25	10
20978	T25	25	10
20980	T27	25	10
20982	T30	25	10
20984	T40	25	10

# Wiha Torsion bit.

Patented torsion zone for longer service life.

## Style C 6.3 (1/4").



### 7010 HOT HOT Torsion bit, slotted, style C 6.3.

Material: High-grade chrome-vanadium steel, through-hardened, extra-hard.  
Geometry: Torsion zone for protecting against premature breakage of bits under load.

Drive: DIN 3126, ISO 1173, style C 6.3.

Application: Particularly suitable for turning screws in wood and soft materials.

Order-No.	⌀	↔	⊖	↔
05295	5.5	25	0.8	10
05296	6.5	25	1.2	10



### 7011 HOT HOT Torsion bit, Phillips, style C 6.3.

Material: High-grade chrome-vanadium steel, through-hardened, extra-hard.  
Geometry: Patented torsion zone to prevent premature breaking of the bit when under stress.

Drive: DIN 3126, ISO 1173, style C 6.3.

Order-No.	⊕	↔	↔
04486	PH1	25	10
04485	PH2	25	10
04484	PH3	25	10



### 7012 HOT HOT Torsion bit, Pozidriv, style C 6.3.

Material: High-grade chrome-vanadium steel, through-hardened, extra-hard.  
Geometry: Patented torsion zone to prevent premature breaking of the bit when under stress.

Drive: DIN 3126, ISO 1173, style C 6.3.

Order-No.	⊕	↔	↔
04483	PZ1	25	10
04482	PZ2	25	10
04481	PZ3	25	10



### 7015 HOT HOT Torsion bit, TORX®, style C 6.3.

Material: High-grade chrome-vanadium steel, through-hardened, extra-hard.  
Geometry: Torsion zone for protecting against premature breakage of bits under load.

Drive: DIN 3126, ISO 1173, style C 6.3.

Order-No.	⊗	↔	↔
31815	T10	25	10
31816	T15	25	10
31817	T20	25	10
31818	T25	25	10
31819	T30	25	10
31820	T40	25	10

## Style E 6.3 (1/4").



### 7041 HOT HOT Torsion bit, Phillips, style E 6.3.

Material: High-grade chrome-vanadium steel, through-hardened, extra-hard.  
Geometry: Patented torsion zone to prevent premature breaking of the bit when under stress.

Drive: DIN 3126, ISO 1173, style E 6.3.

Application: Particularly suitable for turning screws in wood and soft materials.

Order-No.	⊕	↔	↔
04544	PH1	50	5
04543	PH2	50	5
04542	PH3	50	5



### 7042 HOT HOT Torsion bit, Pozidriv, style E 6.3.

Material: High-grade chrome-vanadium steel, through-hardened, extra-hard.  
Geometry: Patented torsion zone to prevent premature breaking of the bit when under stress.

Drive: DIN 3126, ISO 1173, style E 6.3.

Application: Particularly suitable for turning screws in wood and soft materials.

Order-No.	⊕	↔	↔
04550	PZ1	50	5
04549	PZ2	50	5
04548	PZ3	50	5



### 7045 HOT HOT Torsion bit, TORX®, style E 6.3.

Material: High-grade chrome-vanadium steel, through-hardened, extra-hard.  
Geometry: Torsion zone for protecting against premature breakage of bits under load.

Drive: DIN 3126, ISO 1173, style E 6.3.

Application: Particularly suitable for turning screws in wood and soft materials.

Order-No.	⊗	↔	↔
33666	T10	50	5
33667	T15	50	5
33668	T20	50	5
33669	T25	50	5
33670	T30	50	5
33671	T40	50	5

# Wiha Torsion bit.

Patented torsion zone for longer service life.

## Style C 6.3 (1/4").



### 7010 ZOT ZOT Torsion bit, slotted, style C 6.3.

Material: High-quality chrome-vanadium steel, through-hardened, hard but elastic.

Geometry: Torsion zone for protecting against premature breakage of bits under load.

Drive: DIN 3126, ISO 1173, style C 6.3.

Application: Particularly suitable for turning screws in metal and hard materials.

Order-No.	⊕	↔	⊖	▬
05288	4.5	25	0.6	10
05289	5.5	25	0.8	10
05290	5.5	25	1.0	10
05292	6.5	25	1.2	10
05293	8.0	25	1.2	10



### 7011 ZOT ZOT Torsion bit, Phillips, style C 6.3.

Material: High-quality chrome-vanadium steel, through-hardened, hard but elastic.

Geometry: Patented torsion zone to prevent premature breaking of the bit when under stress.

Order-No.	⊕	↔	▬
05299	PH1	25	10
05076	PH2	25	10
05077	PH3	25	10



### 7011 ZOT L ZOT Torsion bit, Phillips, style C 6.3.

Material: High-quality chrome-vanadium steel, through-hardened, hard but elastic.

Geometry: Patented torsion zone to prevent premature breaking of the bit when under stress.

Order-No.	⊕	↔	▬
04699	PH1	50	10
04697	PH2	50	10
04695	PH3	50	10



### 7011 ACR ACR® Torsion bit, Phillips, style C 6.3.

Material: High-quality chrome-vanadium steel, through-hardened, hard but elastic.

Geometry: Patented torsion zone to prevent premature breaking of the bit when under stress.

Drive: DIN 3126, ISO 1173, style C 6.3.

Extra: Anti-Cam-Out ribs ensure a secure grip in the screw and good force transfer.

Order-No.	⊕	↔	▬
04919	PH1	25	10
04920	PH2	25	10
04921	PH3	25	10

## Style C 6.3 (1/4").



### 7012 ZOT ZOT Torsion bit, Pozidriv, style C 6.3.

Geometry: Patented torsion zone to prevent premature breaking of the bit when under stress.

Order-No.	⊕	↔	▬
05074	PZ1	25	10
05075	PZ2	25	10
05069	PZ3	25	10



### 7012 ZOT L ZOT Torsion bit, Pozidriv, style C 6.3.

Geometry: Patented torsion zone to prevent premature breaking of the bit when under stress.

Order-No.	⊕	↔	▬
04693	PZ1	50	10
04691	PZ2	50	10
04689	PZ3	50	10



### 7012 ACR ACR® Torsion bit, Pozidriv, style C 6.3.

Geometry: High-quality chrome-vanadium steel, through-hardened, hard but elastic.

Extra: Anti-Cam-Out ribs ensure a secure grip in the screw and good force transfer.

Order-No.	⊕	↔	▬
04922	PZ1	25	10
04923	PZ2	25	10
04924	PZ3	25	10



### 7015 ZOT ZOT Torsion bit, TORX®, style C 6.3.

Material: High-quality chrome-vanadium steel, through-hardened, hard but elastic.

Geometry: Torsion zone for protecting against premature breakage of bits under load.

Order-No.	⊕	↔	▬
20940	T6	25	10
20942	T7	25	10
20945	T8	25	10
20946	T9	25	10
20948	T10	25	10
20950	T15	25	10
20952	T20	25	10
20954	T25	25	10
20956	T27	25	10
20958	T30	25	10
20960	T40	25	10

# Wiha Torsion bit.

Patented torsion zone for longer service life.

## Style C 6.3 and E 6.3 (1/4").



### 7019 ZOT TW ZOT Torsion bit, Tri-Wing®, style C 6.3.

**Material:** High-quality chrome-vanadium steel, through-hardened, hard but elastic.  
**Geometry:** Torsion zone for protecting against premature breakage of bits under load.  
**Drive:** DIN 3126, ISO 1173, style C 6.3.  
**Application:** For Tri-Wing® security screws.

Order-No.	⊕	↔	▬
22603	0	25	10
22604	1	25	10
22605	2	25	10
22606	3	25	10
22607	4	25	10
22608	5	25	10



### 7019 ZOT TS ZOT Torsion bit, Torq-Set®, style C 6.3.

**Material:** High-quality chrome-vanadium steel, through-hardened, hard but elastic.  
**Geometry:** Torsion zone for protecting against premature breakage of bits under load.  
**Drive:** DIN 3126, ISO 1173, style C 6.3.  
**Application:** For Torq-Set® security screws.

Order-No.	⊕	↔	▬
27030	0	25	10
27028	1	25	10
26249	2	25	10
26045	3	25	10
22591	4	25	10
22592	5	25	10
22593	6	25	10
22594	8	25	10
22595	10	25	10
25572	1/4	32	10



### 7041 ZOT ZOT Torsion bit, Phillips, style E 6.3.

**Material:** High-quality chrome-vanadium steel, through-hardened, hard but elastic.  
**Geometry:** Patented torsion zone to prevent premature breaking of the bit when under stress.  
**Drive:** DIN 3126, ISO 1173, style E 6.3.  
**Application:** Particularly suitable for turning screws in metal and hard materials.

Order-No.	⊕	↔	▬
04541	PH1	50	5
04540	PH2	50	5
04539	PH3	50	5

## Style E 6.3 (1/4").



### 7042 ZOT ZOT Torsion bit, Pozidriv, style E 6.3.

**Material:** High-quality chrome-vanadium steel, through-hardened, hard but elastic.  
**Geometry:** Patented torsion zone to prevent premature breaking of the bit when under stress.  
**Drive:** DIN 3126, ISO 1173, style E 6.3.  
**Application:** Particularly suitable for turning screws in metal and hard materials.

Order-No.	⊕	↔	▬
04547	PZ1	50	5
04546	PZ2	50	5
04545	PZ3	50	5



### 7049 ZOT TW ZOT Torsion bit, Tri-Wing®, style E 6.3.

**Material:** High-quality chrome-vanadium steel, through-hardened, hard but elastic.  
**Geometry:** Torsion zone for protecting against premature breakage of bits under load.  
**Drive:** DIN 3126, ISO 1173, style E 6.3.  
**Application:** For Tri-Wing® security screws.  
**Extra:** 90 mm bits with long spiralled torsion zone.

Order-No.	⊕	↔	▬
22609	3	50	5
33695	3	90	5
22610	4	50	5
33696	4	90	5
22611	5	50	5
33697	5	90	5
22612	6	50	5
33698	6	90	5



### 7049 ZOT TS ZOT Torsion bit, Torq-Set®, style E 6.3.

**Material:** High-quality chrome-vanadium steel, through-hardened, hard but elastic.  
**Geometry:** Torsion zone for protecting against premature breakage of bits under load.  
**Drive:** DIN 3126, ISO 1173, style E 6.3.  
**Application:** For Torq-Set® security screws.  
**Extra:** 90 mm bits with long spiralled torsion zone.

Order-No.	⊕	↔	▬
22596	4	50	5
33699	4	90	5
22597	5	50	5
33700	5	90	5
22598	6	50	5
33701	6	90	5
22599	8	50	5
33702	8	90	5
22600	10	50	5

# Wiha Inkra bit.

The specialist for every angle.



## The innovation for wood screws.

With the Inkra bit, Wiha has developed a revolutionary product for dry applications.

In practice, it is impossible to avoid working with an inclined bit axis. It is in such applications that the Inkra bit comes into its own. With its specially developed shape, the penetration depth in the screw head remains nearly constant, even in an inclined position.

Optimum torque transmission and a reduced cam-out effect are the resulting advantages.

Craftsmen value this bit because it makes their work much easier than using a standard bit.

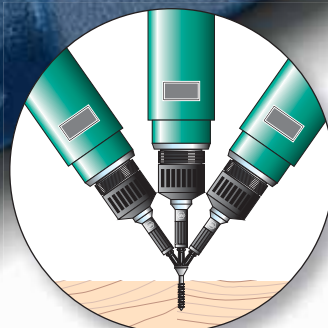

User comfort and reduced pressure forces even in inclined positions.

Slippage and rounding of the bit tip are a thing of the past.



## Wiha Inkra bit.

- Even when the drill is at an inclined position, the penetration depth in the screw head remains virtually constant
- No slipping and rounding of the bit tip and screw head
- Especially long service life
- The ideal bit for carpenters, joiners and craftsmen

## Style C 6.3 (1/4").



### 7011 Inkra Inkra bit, Phillips, style C 6.3.

Material: High grade chrome-vanadium steel, through hardened.

Drive: DIN 3126, ISO 1173, style C 6.3.

Application: The ideal bit for areas that are difficult to access, particularly suitable for wood screws.

Extra: Non-corrosive coating.

Fastening possible at slightly oblique angles.

Order-No.	⊕	↔	▬
21228	PH1	25	10
20834	PH2	25	10
21229	PH3	25	10

## Style E 6.3 (1/4").



### 7041 Inkra Inkra bit, Phillips, style E 6.3.

Material: High grade chrome-vanadium steel, through hardened.

Drive: DIN 3126, ISO 1173, style E 6.3.

Application: The ideal bit for areas that are difficult to access, particularly suitable for wood screws.

Extra: Non-corrosive coating.

Fastening possible at slightly oblique angles.

Order-No.	⊕	↔	▬
32499	PH1	50	5
32500	PH2	50	5
32501	PH3	50	5



### 7012 Inkra Inkra bit, Pozidriv, style C 6.3.

Order-No.	⊕	↔	▬
21231	PZ1	25	10
08461	PZ2	25	10
21233	PZ3	25	10

### 7042 Inkra Inkra bit, Pozidriv, style E 6.3.

Order-No.	⊕	↔	▬
32502	PZ1	50	5
32503	PZ2	50	5
32504	PZ3	50	5



# Wiha Standard bit.

Full programme range in outstanding quality.



The Wiha Standard bits offer impressive quality and they are available in a versatile range.

The bits are subject to processor-aided manufacture as well as processor controlled heat treatment. Wiha thus guarantees a uniformly high product quality.



*The high-quality basic material permits torque values that are far beyond the DIN standards:*

- DIN 5261 for PH/PZ-bits
- DIN 5263 for slotted bits
- Camcar standards for TORX® and TORX PLUS® bits

*This results in a long tool life at high torque values; this is the ideal prerequisite for standard applications.*

*Wiha Standard bits are the ideal multi-purpose tool to meet high requirements in terms of both quality and performance.*



## Wiha Standard bit.

- Robust and powerful allround-bits for trade, industry and DIY
- Suitable for all applications. Thanks to its hardness values of HRC 59-61, it can be used for both manual and machine applications
- Highly resistant to wear and tear for a long tool life
- Optimum fitting in DIN screws for low wear and tear as well as optimum torque transmission
- Production based on industrial quality criteria according to the valid ISO standards with uniformly high product quality

## Style C 6.3 (1/4").

**7010 Z** Standard bit, slotted, style C 6.3.

Material: High grade chrome-vanadium steel, through hardened.

Drive: DIN 3126, ISO 1173, style C 6.3.

Application: For all types of screw applications in trade and industry.

Order-No.	⌀	↔	⊖	↔
01623	4.5	25	0.6	10
01624	5.5	25	0.8	10
01626	6.5	25	1.2	10
01627	8.0	25	1.6	10

## Style C 6.3 (1/4").

**7011 Z** Standard bit, Phillips, style C 6.3.

Material: High grade chrome-vanadium steel, through hardened.

Drive: DIN 3126, ISO 1173, style C 6.3.

Application: For all types of screw applications in trade and industry.

Order-No.	⊕	↔	↔
05298	PH0	25	10
01657	PH1	25	10
01658	PH2	25	10
01659	PH3	25	10
01649	PH4	32	10

**7010 Z L** Standard bit, slotted, style C 6.3.

Material: High grade chrome-vanadium steel, through hardened.

Drive: DIN 3126, ISO 1173, style C 6.3.

Application: For all types of screw applications in trade and industry.

Order-No.	⌀	↔	⊖	↔
01604	3.0	39	0.5	10
01607	3.5	39	0.6	10
01606	4.0	39	0.5	10
01610	4.0	39	0.8	10
01609	4.5	39	0.6	10
01612	5.5	39	0.8	10
01613	5.5	39	1.0	10
01617	6.5	39	1.2	10
01619	8.0	39	1.2	10
01621	8.0	39	1.6	10

**NEW****7011 DWS** Drywall stop bit, Phillips, style C 6.3, in a plastic box.

Material: High grade chrome-vanadium steel, through hardened.

Drive: DIN 3126, ISO 1173, style C 6.3.

Application: The ideal bit for drywall constructors.

Extra: The blue ring prevents the screw from being recessed too deeply into the plasterboard.

Order-No.	⊕	↔	↔
20150	PH2	25	10

**7012 Z** Standard bit, Pozidriv, style C 6.3.

Material: High grade chrome-vanadium steel, through hardened.

Drive: DIN 3126, ISO 1173, style C 6.3.

Application: For all types of screw applications in trade and industry.

Order-No.	⊕	↔	↔
05300	PZ0	25	10
01688	PZ1	25	10
01689	PZ2	25	10
01690	PZ3	25	10
01681	PZ4	32	10

# Wiha Standard-Bit.

Full programme range in outstanding quality.

## Style C 6.3 (1/4").



### 7015 Z Standard bit, TORX®, style C 6.3.

Material: High grade chrome-vanadium steel, through hardened.  
 Drive: DIN 3126, ISO 1173, style C 6.3.  
 Application: For all types of screw applications in trade and industry.

Order-No.	⊕	↔	▬
26250	T3	25	10
25097	T4	25	10
01711	T5	25	10
01712	T6	25	10
01713	T7	25	10
01714	T8	25	10
01715	T9	25	10
01716	T10	25	10
01717	T15	25	10
01718	T20	25	10
01719	T25	25	10
01720	T27	25	10
01721	T30	25	10
01722	T40	25	10
01723	T45	35	10
01724	T50	35	10

## Style C 6.3 (1/4").

### 7016 Z Standard bit, TORX PLUS®, style C 6.3.

Material: High grade chrome-vanadium steel, through hardened.  
 Drive: DIN 3126, ISO 1173, style C 6.3.  
 Application: For all types of screw applications in trade and industry.  
 Extra: Reinforced profile cross-section transfers approx. 25% more torque than with a TORX® profile.

Order-No.	⊕	↔	▬
25994	3IP	25	10
25996	4IP	25	10
25998	5IP	25	10
23173	6IP	25	10
23175	7IP	25	10
23177	8IP	25	10
23179	9IP	25	10
23181	10IP	25	10
23183	15IP	25	10
23185	20IP	25	10
23187	25IP	25	10
23189	27IP	25	10
23191	30IP	25	10
23193	40IP	25	10



### 7015K Z Standard bit, TORX® conic, style C 6.3.

Extra: Conical profile.

Order-No.	⊕	↔	▬
04925	T10	25	10
04926	T15	25	10
04927	T20	25	10
04928	T25	25	10
04929	T27	25	10
04930	T30	25	10
04931	T40	25	10

### 7016 Z IPR Standard bit, TORX PLUS® Security, style C 6.3.

Material: High grade chrome-vanadium steel, through hardened.  
 Drive: DIN 3126, ISO 1173, style C 6.3.  
 Application: For all types of screw applications in trade and industry.  
 Attention: Security profile - sold only to authorised customers. Written proof of authorisation must be received.

Order-No.	⊕	↔	▬
27530	8IPR	25	10
26346	10IPR	25	10
26347	15IPR	25	10
26348	20IPR	25	10
26349	25IPR	25	10
26350	30IPR	25	10
26351	40IPR	35	10



### 7015 Z TR Standard bit, TORX® H, style C 6.3.

Extra: Hole in the bit tip for TORX® Tamper Resistant security screws.

Order-No.	⊕	↔	▬
03115	T7H	25	10
03117	T8H	25	10
01726	T9H	25	10
01727	T10H	25	10
01728	T15H	25	10
01729	T20H	25	10
01730	T25H	25	10
01731	T27H	25	10
01732	T30H	25	10
01733	T40H	25	10

## Style C 6.3 (1/4").

**7013 Z** Standard bit, hex, style C 6.3.

Material: High grade chrome-vanadium steel, through hardened.

Drive: DIN 3126, ISO 1173, style C 6.3.

Application: For all types of screw applications in trade and industry.

Order-No.	⌀	↔	≡
04011	1.5	25	10
01703	2.0	25	10
01704	2.5	25	10
01705	3.0	25	10
01706	4.0	25	10
01707	5.0	25	10
01708	6.0	25	10
01709	8.0	25	10
01710	10.0	25	10

**7013R Z** Standard bit, hex, style C 6.3.

Material: High grade chrome-vanadium steel, through hardened.

Drive: DIN 3126, ISO 1173, style C 6.3.

Application: For all types of screw applications in trade and industry. Insert screws into or remove from boreholes, especially in difficult to access areas.

Extra: MagicRing® made from spring steel holds all standard screws in every position.

Order-No.	⌀	↔	≡
22955	3.0	25	10
22956	4.0	25	10
22957	5.0	25	10
22958	6.0	25	10

**7013 Z TR** Standard bit, hex Tamper Resistant, style C 6.3.

Material: High grade chrome-vanadium steel, through hardened.

Drive: DIN 3126, ISO 1173, style C 6.3.

Extra: Hole in the tip of the bit for hex Tamper Resistant security screws.

Order-No.	⊙	↔	≡
25560	TR2.0	25	10
25561	TR2.5	25	10
25562	TR3.0	25	10
25563	TR4.0	25	10
25564	TR5.0	25	10
26309	TR6.0	25	10
20558	TR5/64	25	10
20556	TR3/32	25	10
20559	TR7/64	25	10
20555	TR1/8	25	10
20560	TR9/64	25	10
20557	TR5/32	25	10
30050	TR3/16	25	10

## Style C 6.3 (1/4").

**7017 Z** Standard bit, ball end hex, style C 6.3.

Material: High grade chrome-vanadium steel, through hardened.

Drive: DIN 3126, ISO 1173, style C 6.3.

Application: For all types of screw applications in trade and industry. Especially for screws that are difficult to access. Ideal for window constructors.

Extra: The ball end enables the user to work at angles up to 25°.

Order-No.	⌀	↔	≡
01734	1.5	38	10
01735	2.0	38	10
01736	2.5	38	10
01737	3.0	38	10
01738	4.0	38	10
01739	5.0	38	10
01740	6.0	38	10

**7017R Z** Standard bit, ball end hex, style C 6.3.

Material: High grade chrome-vanadium steel, through hardened.

Drive: DIN 3126, ISO 1173, style C 6.3.

Application: For all types of screw applications in trade and industry. Insert screws into or remove from boreholes, especially in difficult to access areas.

Extra: MagicRing® made from spring steel holds all standard screws in every position. Ball end allows a working angle up to 25°.

Order-No.	⌀	↔	≡
22959	3.0	38	10
22960	4.0	38	10
22961	5.0	38	10
22962	6.0	38	10

## Wiha Info

**Wiha MagicRing®.**

Spring steel ring reliably holds hex screws in place

# Wiha Standard Bit.

Full programme range in outstanding quality.

## Style C 6.3 (1/4").



### 7018 Z Standard bit, Robertson, style C 6.3.

Material: High grade chrome-vanadium steel, through hardened.  
 Drive: DIN 3126, ISO 1173, style C 6.3.  
 Application: For all types of screw applications in trade and industry.  
 Extra: A tapered tip allows for easy insertion of the bit into the screw.

Order-No.		2.3	2.8	3.3	25	5
06634	Robertson 1	2.3	2.8	3.3	25	5
06635	Robertson 2	2.8	2.8	3.3	25	5
06636	Robertson 3	3.3	2.8	3.3	25	5

## Style C 6.3 (1/4").



### 7019 Z SP Standard bit, spanner, style C 6.3.

Material: High grade chrome-vanadium steel, through hardened.  
 Drive: DIN 3126, ISO 1173, style C 6.3.  
 Application: For security screws - snake eye.

Order-No.	4	6	8	10	25	10
27064	4	6	8	10	25	10
27065	6	6	8	10	25	10
27066	8	6	8	10	25	10
27067	10	6	8	10	25	10



### 7019 Z XZN Standard bit, multi-tooth, style C 6.3.

Material: High grade chrome-vanadium steel, through hardened.  
 Drive: DIN 3126, ISO 1173, style C 6.3.  
 Application: For use in automotive applications.

Order-No.	M3	M4	M5	M6	M8	25	35	10
26352	M3	M4	M5	M6	M8	25	35	10
26353	M3	M4	M5	M6	M8	25	35	10
26354	M3	M4	M5	M6	M8	25	35	10
26355	M3	M4	M5	M6	M8	25	35	10
26356	M3	M4	M5	M6	M8	25	35	10



### 7019 Z SIT Standard bit, SIT, style C 6.3.

Material: High grade chrome-vanadium steel, through hardened.  
 Drive: DIN 3126, ISO 1173, style C 6.3.  
 Application: For ASSY® and Pias screws.  
 Extra: With colour-coding.

Order-No.	SIT 10	SIT 20	SIT 25	SIT 30	SIT 40	25	10
27256	SIT 10	SIT 20	SIT 25	SIT 30	SIT 40	25	10
27257	SIT 10	SIT 20	SIT 25	SIT 30	SIT 40	25	10
27258	SIT 10	SIT 20	SIT 25	SIT 30	SIT 40	25	10
27259	SIT 10	SIT 20	SIT 25	SIT 30	SIT 40	25	10
27260	SIT 10	SIT 20	SIT 25	SIT 30	SIT 40	25	10

## Wiha Info

### Colour coding of SIT bits:

-  SIT 10 hot pink
-  SIT 20 orange
-  SIT 25 green
-  SIT 30 yellow
-  SIT 40 light pink



# Wiha Stainless steel bit.

Precision-fitting, powerful and durable.

## Style C 6.3 (1/4").



### 7010ST Stainless steel bit, slotted, style C 6.3.

Material: High-quality, non-rusting stainless steel, completely vacuum-hardened.

Drive: DIN 3126, ISO 1173, style C 6.3.

Application: Ideally suitable for fastening and unfastening of stainless steel screws.

Order-No.	⌀	↔	⊖	↔
32645	4.5	25	0.6	10
32646	5.5	25	0.8	10
32647	6.5	25	1.2	10
32648	8.0	25	1.2	10



### 7011ST Stainless steel bit, Phillips, style C 6.3.

Order-No.	⊕	↔	↔
32649	PH1	25	10
32650	PH2	25	10
32651	PH3	25	10



### 7012ST Stainless steel bit, Pozidriv, style C 6.3.

Order-No.	⊕	↔	↔
32652	PZ1	25	10
32653	PZ2	25	10
32654	PZ3	25	10



### 7015ST Stainless steel bit, TORX®, style C 6.3.

Order-No.	⊗	↔	↔
32655	T8	25	10
32656	T9	25	10
32657	T10	25	10
32658	T15	25	10
32659	T20	25	10
32660	T25	25	10
32661	T30	25	10
32690	T40	25	10

## Style C 6.3 (1/4").



### 7013ST Stainless steel bit, hex, style C 6.3.

Order-No.	⊙	↔	↔
34005	1.5	25	10
34006	2.0	25	10
34007	2.5	25	10
34008	3.0	25	10
34009	4.0	25	10
34010	5.0	25	10
34011	6.0	25	10

## Style E 6.3 (1/4").



### 7041ST Stainless steel bit, Phillips, style E 6.3.

Material: High-quality, non-rusting stainless steel, completely vacuum-hardened.

Drive: DIN 3126, ISO 1173, style C 6.3.

Application: Ideally suitable for fastening and unfastening of stainless steel screws.

Order-No.	⊕	↔	↔
32662	PH1	50	5
32663	PH2	50	5
32664	PH3	50	5



### 7042ST Stainless steel bit, Pozidriv, style E 6.3.

Order-No.	⊕	↔	↔
32665	PZ1	50	5
32666	PZ2	50	5
32667	PZ3	50	5



### 7045ST Stainless steel bit, TORX®, style E 6.3.

Order-No.	⊗	↔	↔
32668	T15	50	5
32669	T20	50	5
32670	T25	50	5
32671	T30	50	5
32672	T40	50	5

# Wiha Professional bits.

Wiha Professional bits - everything but standard.



Wiha Professional Bits are high quality bits for professional users in trade and industry.

#### Complete assortment

Wiha Professional Bits are characterised by an extremely wide product spectrum. More than 200 profile and length variants are available from stock. Of course Wiha is an official licensee of all common screw profiles.

#### Wiha - the TORX® specialist

Ranging from traditional TORX® with all its variants (classic, wedge, tamper resistant) to a wide internal TORX® spectrum and the latest TORX PLUS® safety profile, Wiha as a premium manufacturer offers professional users a complete program.

Added to this are the Wiha specials with ball end and unique swivel angle as well as MagicSpring®, a 'magic' spring that securely holds screws.

#### Precise manufacturing

Production on extremely precise and process-robust CNC systems means high performance screw bits. Modern manufacturing technology ensures not only a perfect fit of profile tips but also outstanding rotation characteristics and concentricity of bits. Demanding customers with automated fastening processes looking for problem-free applications hold this in high regard.

#### Optimal heat treatment

Wiha Professional Bits are fundamentally through-hardened. Heat treatment is carried out in hardening systems with computer-controlled monitoring of hardening parameters (time, temperature, atmosphere). This enables constant hardening results. Wiha Professional Bits gain their functional fine finishing with the final annealing process, a second heat treatment following hardening that gives bits a specific characteristic. According to profile and application area, a differentiation is made between extra hard wear-resistant, tough and extra tough.



#### Wiha Professional bits.

- Powerful bits for professional users.
- Heat treatment matched to the profile to extend the service life
- Optimum fit in screws because of manufacturing according to DIN or the original specifications of well-known licensors
- Best rotation characteristics for stable fastening processes

## Style E 6.3 (1/4").

**7040 Z** Professional bit, slotted, style E 6.3.

Material: High grade chrome-vanadium steel, through hardened.  
 Drive: DIN 3126, ISO 1173, style E 6.3.  
 Application: For all types of screw applications in trade and industry.

Order-No.	⌀	↔	⊖	↔
33961	2.5	70	0.4	5
01790	3.0	50	0.5	5
33962	3.0	70	0.5	5
01792	3.5	50	0.6	5
33963	3.5	70	0.6	5
01791	4.0	50	0.5	5
01794	4.0	50	0.8	5
33964	4.0	70	0.8	5
01793	4.5	50	0.6	5
01795	5.5	50	0.8	5
01796	5.5	50	1.0	5
33965	5.5	70	1.0	5
01798	6.5	50	1.2	5
33966	6.5	70	1.2	5
01799	8.0	50	1.2	5
01800	8.0	50	1.6	5

**7041 Z** Professional bit, Phillips, style E 6.3.

Material: High grade chrome-vanadium steel, through hardened.  
 Drive: DIN 3126, ISO 1173, style E 6.3.  
 Application: For all types of screw applications in trade and industry.  
 Extra: Overlength bits available in lengths of 50, 70, 90, 110, 127 and 150 mm.

Order-No.	⊕	↔	↔
31960	PH00	50	5
31961	PH00	70	5
31962	PH00	90	5
32105	PH0	50	5
35456	PH0	70	5
35457	PH0	90	5
33703	PH1	50	5
01803	PH1	70	5
04126	PH1	90	5
23213	PH1	110	5
23219	PH1	127	5
22509	PH1	150	5
33704	PH2	50	5
01805	PH2	70	5
04009	PH2	90	5
05800	PH2	110	5
06888	PH2	127	5
22510	PH2	150	5
33705	PH3	50	5
04010	PH3	70	5
04127	PH3	90	5
23215	PH3	110	5
23217	PH3	127	5
22511	PH3	150	5

## Style E 6.3 (1/4").

**7049XH** Professional bit, Xeno-slotted/ Phillips, style E 6.3.  
For terminal screws (slotted/ Phillips).

Application: For fastening and unfastening positive/ negative screws in switchboard systems, fuse boxes, terminal blocks and relays.

Order-No.	⊕	↔	↔
32490	SL/PH1	50	5
32491	SL/PH1	70	5
32686	SL/PH1	90	5
32492	SL/PH2	50	5
32493	SL/PH2	70	5
32687	SL/PH2	90	5

**7042 Z** Professional bit, Pozidriv, style E 6.3.

Extra: Overlength bits available in lengths of 50, 70, 90, 110, 127 and 150 mm.

Order-No.	⊕	↔	↔
31957	PZ0	50	5
31958	PZ0	70	5
31959	PZ0	90	5
33706	PZ1	50	5
01808	PZ1	70	5
01809	PZ1	90	5
23221	PZ1	110	5
23225	PZ1	127	5
23227	PZ1	150	5
33707	PZ2	50	5
01811	PZ2	70	5
01812	PZ2	90	5
05799	PZ2	110	5
06889	PZ2	127	5
23228	PZ2	150	5
33708	PZ3	50	5
04059	PZ3	70	5
04176	PZ3	90	5
23223	PZ3	110	5
23226	PZ3	127	5
22512	PZ3	150	5

**7049XZ** Professional bit, Xeno-slotted/ Pozidriv, style E 6.3.  
For terminal screws (slotted/ Pozidriv).

Application: For fastening and unfastening positive/ negative screws in switchboard systems, fuse boxes, terminal blocks and relays.

Order-No.	⊕	↔	↔
32494	SL/PZ1	50	5
32495	SL/PZ1	70	5
32688	SL/PZ1	90	5
32496	SL/PZ2	50	5
32497	SL/PZ2	70	5
32689	SL/PZ2	90	5

# Wiha Professional bit.

Wiha Professional bits - everything but standard.

## Style E 6.3 (1/4").



### 7045R Professional bit, TORX® with MagicSpring®, style E 6.3.

Material: High grade chrome-vanadium steel, through hardened.  
 Drive: DIN 3126, ISO 1173, style E 6.3.  
 Application: For all types of screw applications in trade and industry.  
 Extra: MagicSpring® made of stainless steel holds TORX® screws tight at various angles.  
 Attention: Screw must not be attached to the rotating bit.

Order-No.	☼	↔	➡
34452	T10	50	5
34453	T15	50	5
34454	T20	50	5
34455	T25	50	5
34456	T30	50	5
34457	T40	50	5



### 7046 Z Professional bit, TORX PLUS®, style E 6.3.

Material: High grade chrome-vanadium steel, through hardened.  
 Drive: DIN 3126, ISO 1173, style E 6.3.  
 Application: For all types of screw applications in trade and industry.  
 Extra: Reinforced profile cross-section transfers approx. 25% more torque than with a TORX® profile.

Order-No.	☼	↔	➡
39195	1IP	50 NEW	5
39196	2IP	50 NEW	5
32486	3IP	50 NEW	5
39197	4IP	50 NEW	5
39198	4IP	90 NEW	5
28481	5IP	50	5
39199	5IP	90 NEW	5
26000	6IP	50	5
31973	5IP	90 NEW	5
26002	7IP	50	5
23195	8IP	50	5
31975	8IP	90 NEW	5
23197	9IP	50	5
23199	10IP	50	5
31977	10IP	90 NEW	5
23201	15IP	50	5
25553	15IP	90 NEW	5
23203	20IP	50	5
39200	20IP	90 NEW	5
23205	25IP	50	5
39201	25IP	90 NEW	5
23207	27IP	50	5
39202	27IP	90 NEW	5
23209	30IP	50	5
39203	30IP	90 NEW	5
23211	40IP	50	5
39204	40IP	90 NEW	5

## Style E 6.3 (1/4").



### 7045BE Professional bit, TORX® ball end, style E 6.3.

Material: High grade chrome-vanadium steel, through hardened.  
 Drive: DIN 3126, ISO 1173, style E 6.3.  
 Application: For all internal TORX® screws, especially in hard-to-reach places.  
 Extra: The TORX® ball end enables fastening and unfastening at an angle of up to 25°. With elongated TORX® profile behind ball end.

Order-No.	☼	↔	➡
32409	T9	50	5
32410	T10	50	5
32416	T10	70	5
32417	T15	50	5
32418	T15	70	5
32411	T20	50	5
32419	T20	70	5
32420	T20	90	5
32412	T25	50	5
32421	T25	70	5
32422	T25	90	5
32413	T27	50	5
32414	T30	50	5
32423	T30	70	5
32424	T30	90	5
32415	T40	50	5



### 7045BE 9570 Professional bits TORX® ball end in compact bit band, 10 pcs. Blister packed.

Bits: 70 mm Standard bits.  
 Application: Extra long bits for all types of fastening in trade and industry.  
 Extra: Compact plastic bit band with belt clip.

Order-No.	Series	➡
32804	7045BE 9570	1
	☼ 7045BE	2xT10 2xT15 2xT20 2xT25 2xT30

## Style E 6.3 (1/4").

**7045 Z** Professional bit, TORX®, style E 6.3.

Material: High grade chrome-vanadium steel, through hardened.  
 Drive: DIN 3126, ISO 1173, style E 6.3.  
 Application: For all types of screw applications in trade and industry.  
 Extra: Overlength bits in lengths of 50, 70, 90, 110 and 150 mm.

Order-No.	⊕	↔		▬
39184	T1	50	NEW	5
39185	T2	50	NEW	5
39186	T3	50	NEW	5
39187	T4	50	NEW	5
32299	T5	50		5
32302	T6	50		5
33709	T6	70		5
33717	T6	90		5
38370	T6	150	NEW	5
32303	T7	50		5
33710	T7	70		5
33718	T7	90		5
38371	T7	150	NEW	5
32304	T8	50		5
33711	T8	70		5
33719	T8	90		5
36327	T8	150	NEW	5
32305	T9	50		5
33712	T9	70		5
33720	T9	90		5
38372	T9	150	NEW	5
32306	T10	50		5
33713	T10	70		5
33721	T10	90		5
33725	T10	110		5
33726	T10	150		5
32307	T15	50		5
33714	T15	70		5
33722	T15	90		5
33727	T15	110		5
33728	T15	150		5
32308	T20	50		5
33715	T20	70		5
33723	T20	90		5
33729	T20	110		5
33730	T20	150		5
32309	T25	50		5
33716	T25	70		5
33724	T25	90		5
33731	T25	110		5
33732	T25	150		5
33920	T27	50		5
33921	T27	70		5
33922	T27	90		5
33923	T30	50		5
33924	T30	70		5
33925	T30	90		5
33926	T30	110		5
33927	T30	150		5
33928	T40	50		5
33929	T40	70		5
33930	T40	90		5
33931	T40	110		5
33932	T40	150		5

## Style E 6.3 (1/4").

**7045 Z TR** Professional bit, TORX® H, style E 6.3.

Material: High grade chrome-vanadium steel, through hardened.  
 Drive: DIN 3126, ISO 1173, style E 6.3.  
 Application: For all types of screw applications in trade and industry.  
 Extra: Hole in the bit tip for TORX® Tamper Resistant security screws.

Order-No.	⊕	↔		▬
21045	T7H	50		5
21047	T8H	50		5
20218	T9H	50		5
20219	T10H	50		5
39188	T10H	90	NEW	5
24867	T15H	50		5
39189	T15H	90	NEW	5
20220	T20H	50		5
39190	T20H	90	NEW	5
20221	T25H	50		5
39191	T25H	90	NEW	5
20222	T27H	50		5
39192	T27H	90	NEW	5
20223	T30H	50		5
39193	T30H	90	NEW	5
20224	T40H	50		5
39194	T40H	90	NEW	5

**7048 Z** Professional bit, Robertson, style E 6.3.

Material: High grade chrome-vanadium steel, through hardened.  
 Drive: DIN 3126, ISO 1173, style E 6.3.  
 Application: For all types of screw applications in trade and industry.  
 Extra: A tapered tip allows for easy insertion of the bit into the screw.

Order-No.	⊕	⊕	↔	▬	
06637	Robertson 1	2.3	50	5	
39206	Robertson 1	2.3	90	NEW	5
06638	Robertson 2	2.8	50	5	
39207	Robertson 2	2.8	90	NEW	5
06639	Robertson 3	3.3	50	5	
39208	Robertson 3	3.3	90	NEW	5



# Wiha Professional bit.

Wiha Professional bits - everything but standard.

## Style E 6.3 (1/4").



### 7047R Z Professional bit, ball end hex, style E 6.3.

**Material:** High grade chrome-vanadium steel, through hardened.  
**Drive:** DIN 3126, ISO 1173, style E 6.3.  
**Application:** For all types of screw applications in trade and industry.  
 To insert and remove screws from holes or cavities, specially in difficult to access areas.  
**Extra:** MagicRing® made from spring steel holds all standard screws in every position. Ball end allows a working angle up to 25°.

Order-No.	●	↔	▬
25739	3.0	50	5
25740	4.0	50	5
25741	5.0	50	5
25742	6.0	50	5



### 7043R Z Professional bit, hex, style E 6.3.

**Extra:** MagicRing® made from spring steel holds all standard screws in every position.

Order-No.	●	↔	▬
23145	3.0	50	5
23147	4.0	50	5
23149	5.0	50	5
23151	6.0	50	5



### 7043 Z Professional bit, hex, style E 6.3.

Order-No.	●	↔	▬
05301	1.5	50	5
05302	2.0	50	5
34554	2.0	70	5
39178	2.0	90 NEW	5
05303	2.5	50	5
34555	2.5	70	5
39179	2.5	90 NEW	5
04194	3.0	50	5
34556	3.0	70	5
39180	3.0	90 NEW	5
04195	4.0	50	5
34557	4.0	70	5
39181	4.0	90 NEW	5
04196	5.0	50	5
34558	5.0	70	5
39182	5.0	90 NEW	5
04197	6.0	50	5
34559	6.0	70	5
39183	6.0	90 NEW	5
04198	8.0	50	5
34560	8.0	70	5

## Displays.



### 7041 VB1 Single bits display, 90 mm bits. Acryl glass display with 70 pieces.

**Size:** 22 x 19 x 35 cm (WxDxH).

Order-No.	Series	▬		
36162	7041 VB1	1		
⊕	7041 Z	5xPH1	5xPH2	5xPH3
⊕	7042 Z	5xPZ1	5xPZ2	5xPZ3
⊕	7045 Z	5xT10	5xT15	5xT20
		5xT25	5xT30	5xT40
7143	- 1/4 5xUniversal holder 150 mm magnetic - 1/4"			
	- 1/2 5xUniversal holder 100 mm magnetic - 1/4"			

### 7041 VB2 Single bits display, 150 mm bits. Acryl glass display with 70 pieces.

**Size:** 22 x 19 x 35 cm (WxDxH).

Order-No.	Series	▬		
36163	7041 VB2	1		
⊕	7041 Z	5xPH1	5xPH2	5xPH3
⊕	7042 Z	5xPZ1	5xPZ2	5xPZ3
⊕	7045 Z	5xT10	5xT15	5xT20
		5xT25	5xT30	5xT40
7143	- 1/4 5xUniversal holder 150 mm magnetic - 1/4"			
	- 1/2 5xUniversal holder 100 mm magnetic - 1/4"			

## Wiha Info



### Wiha MagicRing®.

Spring steel ring reliably holds hex screws in place

# Wiha Industrial bits.

Specialists for series connections.

## Halfmoon, 4 mm.



**NEW**

### 7041 HM Industrial bit, Phillips, Halfmoon 4 mm.

Material: High grade chrome-vanadium steel, through hardened.

Drive: Halfmoon, 4 mm.

Application: Optimised for industrial use.

Extra: Precision-milled, rotation run-out < 0.2 mm. Further dimensions on request.

Order-No.	⊕	↔	●↓	▬
31928	PH00	44	1.8	5
31929	PH00	64	1.8	5
31930	PH0	44	2.0	5
31931	PH0	64	2.0	5
31932	PH1	44	3.0	5
31933	PH1	64	3.0	5

## Wing shape (HIOS), 4 mm.



**NEW**

### 7041 HS Industrial bit, Phillips, wing shape (HIOS) 4 mm.

Material: High grade chrome-vanadium steel, through hardened.

Drive: Wing shape (HIOS), 4 mm.

Application: Optimised for industrial use.

Extra: Precision-milled, rotation run-out < 0.2 mm. Further dimensions on request.

Order-No.	⊕	↔	●↓	▬
39219	PH00	40	1.8	5
31964	PH00	60	1.8	5
39220	PH0	40	2.0	5
31965	PH0	60	2.0	5
39221	PH1	40	3.0	5
31966	PH1	60	3.0	5



**NEW**

### 7043 HM Industrial bit, hex, Halfmoon 4 mm.

Extra: Precision-milled, rotation run-out < 0.2 mm. Further dimensions on request.

Order-No.	⊙	↔	●↓	▬
39209	1.5	44	2.5	5
39210	2.0	44	2.5	5
39211	2.5	44	3.0	5
39212	3.0	44	3.5	5



**NEW**

### 7045 HS Industrial bit, TORX®, wing shape (HIOS) 4 mm.

Extra: Precision-milled, rotation run-out < 0.2 mm. Further dimensions on request.

Order-No.	⊙	↔	●↓	▬
39222	T1	40	1.5	5
39223	T2	40	1.5	5
39224	T3	40	1.8	5
39225	T4	40	1.8	5
39226	T5	40	2.0	5
39227	T6	40	2.0	5
39228	T7	40	2.5	5
39229	T8	40	3.0	5
39230	T9	40	3.0	5
39231	T10	40	3.0	5



**NEW**

### 7045 HM Industrial bit, TORX®, Halfmoon 4 mm.

Extra: Precision-milled, rotation run-out < 0.2 mm. Further dimensions on request.

Order-No.	⊙	↔	●↓	▬
39213	T1	44	1.5	5
31934	T2	44	1.5	5
31936	T4	44	1.8	5
31938	T4	44	1.8	5
31939	T4	64	1.8	5
31940	T5	44	2.0	5
31941	T5	64	2.0	5
31942	T6	44	2.0	5
31943	T6	64	2.0	5
39214	T7	44	2.3	5
39215	T7	64	2.3	5
31944	T8	44	3.0	5
31945	T8	64	3.0	5



**NEW**

### 7046 HS Industrial bit, TORX PLUS®, wing shape (HIOS) 4 mm.

Extra: Precision-milled, rotation run-out < 0.2 mm. Further dimensions on request.

Order-No.	⊙	↔	●↓	▬
39232	1IP	40	1.5	5
39233	2IP	40	1.5	5
39234	3IP	40	1.8	5
39235	4IP	40	1.8	5
39236	5IP	40	2.0	5
39237	6IP	40	2.0	5
39238	7IP	40	2.5	5
39239	8IP	40	3.0	5
39240	9IP	40	3.0	5
39241	10IP	40	3.0	5



**NEW**

### 7046 HM Industrial bit, TORX PLUS®, Halfmoon 4 mm.

Extra: Precision-milled, rotation run-out < 0.2 mm. Further dimensions on request.

Order-No.	⊙	↔	●↓	▬
39216	1IP	44	1.5	5
31984	2IP	44	1.5	5
31986	3IP	44	1.8	5
31947	4IP	44	1.8	5
31948	4IP	64	1.8	5
31949	5IP	44	2.0	5
31950	5IP	64	2.0	5
31951	6IP	44	2.5	5
31952	6IP	64	2.5	5
39217	7IP	44	3.0	5
39218	7IP	64	3.0	5
31953	8IP	44	3.0	5
31954	8IP	64	3.0	5

## Wiha Info

### Wiha Industrial bits.

- Halfmoon and HIOS bits are mainly used in production lines for high-tech products such as smartphones
- The force is transmitted to the bit via drivers in semi-circles or wing shapes
- Process stability thanks to precision-fitting profiles and excellent rotation characteristics
- The bits are held securely in place in the circumferential groove using a ball latch
- The round 4 mm shaft ensures secure grip without play in the bit mount of the drive spindle
- The bits can be exchanged quickly and easily

# Wiha threaded bit.

Customised for your application.

## For M4 and M5.



### 7311 Z Threaded bit M4, Phillips.

Material: High grade chrome-vanadium steel, through hardened.  
 Drive: Screw thread M4.  
 Application: For optimised use in stationary screw systems.

Order-No.	⊕	↔	●	⊖	↔	☰
01937	PH1	33	5.5	M4	8.00	10
01938	PH2	33	6.0	M4	8.00	10



### 7312 Z Threaded bit M4, Pozidriv.

Material: High grade chrome-vanadium steel, through hardened.  
 Drive: Screw thread M4.  
 Application: For optimised use in stationary screw systems.

Order-No.	⊕	↔	●	⊖	↔	☰
01939	PZ1	33	5.5	M4	8.00	10
01940	PZ2	33	6.0	M4	8.00	10



### 7321 Z Threaded bit M5, Phillips.

Material: High grade chrome-vanadium steel, through hardened.  
 Drive: Screw thread M5.  
 Application: For optimised use in stationary screw systems.

Order-No.	⊕	↔	●	⊖	↔	☰
01942	PH2	33	7.0	M5	8.00	10
01943	PH2	45	6.0	M5	8.00	10



### 7322 Z Threaded bit M5, Pozidriv.

Material: High grade chrome-vanadium steel, through hardened.  
 Drive: Screw thread M5.  
 Application: For optimised use in stationary screw systems.

Order-No.	⊕	↔	●	⊖	↔	☰
01945	PZ2	33	7.0	M5	8.00	10
01946	PZ2	45	6.0	M5	8.00	10



### 7325 Z Threaded bit M5, TORX®.

Material: High grade chrome-vanadium steel, through hardened.  
 Drive: Screw thread M5.  
 Application: For optimised use in stationary screw systems.

Order-No.	⊕	↔	●	⊖	↔	☰
35400	T10	45	6.0	M5	8.00	10
35401	T15	45	6.0	M5	8.00	10
35402	T20	45	6.0	M5	8.00	10
35403	T25	45	6.0	M5	8.00	10

## For M6 and 10/32" UNF.



### 7331 Z Threaded bit M6, Phillips.

Material: High grade chrome-vanadium steel, through hardened.  
 Drive: Screw thread M6.  
 Application: For optimised use in stationary screw systems.

Order-No.	⊕	↔	●	⊖	↔	☰
04678	PH2	33	8.0	M6	8.00	10
04677	PH2	45	8.0	M6	8.00	10



### 7332 Z Threaded bit M6, Pozidriv.

Material: High grade chrome-vanadium steel, through hardened.  
 Drive: Screw thread M6.  
 Application: For optimised use in stationary screw systems.

Order-No.	⊕	↔	●	⊖	↔	☰
04671	PZ2	33	8.0	M6	8.00	10
04670	PZ2	45	8.0	M6	8.00	10



### 7341 Z Threaded bit 10/32" UNF, Phillips.

Material: High grade chrome-vanadium steel, through hardened.  
 Drive: Screw thread 10/32" UNF.  
 Application: For optimised use in stationary screw systems.

Order-No.	⊕	↔	●	⊖	↔	☰
01947	PH2	45	6.0	10/32	8.00	10



















### 7342 Z Threaded bit 10/32" UNF, Pozidriv.

Material: High grade chrome-vanadium steel, through hardened.  
 Drive: Screw thread 10/32" UNF.  
 Application: For optimised use in stationary screw systems.

Order-No.	⊕	↔	●	⊖	↔	☰
01948	PZ2	45	6.0	10/32	8.00	10

# Wiha special bits.

Customised for your application.

Construction Kit	Drive	No.	Profile	No.	Length
	C 4	= 0	 Slotted	= 0	for 25 mm - 152 mm
	C 6,3	= 1	 Phillips PH	= 1	
	C 8	= 2	 Pozidriv PZ	= 2	
	A 5,5	= 3	 Hex	= 3	
	E 6,3	= 5	 TORX®	= 5	
	G 7	= 6	 TORX PLUS®	= 6	
			 Ball end hex	= 7	
			 Robertson	= 8	
			Sonderprofil	= 9	
			 Spanner	= 9 SP	
			 Torq-Set®	= 9 TS	
			 Tri-Wing®	= 9 TW	



Make the most of our experience. Our expertise in the manufacture of all types of fastening tools enables us to produce bits to your specifications.

Sophisticated manufacturing facilities with qualified employees, state-of-the-art machinery and a certified quality assurance system guarantee you maximum quality and flexibility.

## Wiha special bit range - the construction kit of your special bit.



The Wiha special bit range is a construction kit system for your special bit.

### Advantages:

- Attractive price
- No additional costs for technical drawings
- Short delivery time
- Flexibility

### Wiha industrial quality - bits to the highest standard

Industrial quality expands the Wiha construction kit. We adapt the hardness, coating, form and concentricity of the bits precisely according to your requirements.

Hardness: 57 HRC - 63 HRC  
Coating: Tungsten Carbide (Dura), Diamond, TiN  
Form: according to specification drawings  
Straightness: straightness with a tolerance of +/- 0.05 mm

### Perfect concentricity:

essential for bits in automated machines and/or with use of guide jackets.

### Advantages:

- Screws easily located and fastened securely.
- Low-vibration fastening thanks to minimum imbalance.
- Idle times reduced.



## Wiha special bits.

- Our customers require an exact fit and maximum truth of running for a frictionless production process.
- Wiha bits are being used to optimum effect by big-name companies operating all over the world.

Contact us.  
We would be pleased to help.!

# Wiha bits for drive system C<sub>4</sub>

For screw connections in miniature applications.

These bits fit directly in the machines of the manufacturers: **Perret**



## 7000 Z Standard bit, slotted, style C 4.

Material: High grade chrome-vanadium steel, through hardened.  
 Drive: DIN 3126, ISO 1173, style C 4.  
 Application: For particularly small screws.

Order-No.	⌀	↔	⊖	🔧
04728	0.8	28	0.20	10
04727	1.2	28	0.25	10
04726	1.5	28	0.25	10
04725	1.8	28	0.30	10
04724	2.0	28	0.40	10
04723	2.5	28	0.40	10
04722	3.0	28	0.50	10
04721	3.5	28	0.60	10
04729	4.0	28	0.80	10



## 7003 Z Standard bit, hex, style C 4.

Material: High grade chrome-vanadium steel, through hardened.  
 Drive: DIN 3126, ISO 1173, style C 4.  
 Application: For particularly small screws.

Order-No.	⌀	↔	🔧
04737	0.7	28	10
04736	0.9	28	10
04735	1.3	28	10
04734	1.5	28	10
04733	2.0	28	10
04732	2.5	28	10
04731	3.0	28	10
04730	4.0	28	10



## 7001 Z Standard bit, Phillips, style C 4.

Material: High grade chrome-vanadium steel, through hardened.  
 Drive: DIN 3126, ISO 1173, style C 4.  
 Application: For particularly small screws.

Order-No.	⊕	↔	🔧
04720	PH000	28	10
04719	PH00	28	10
04718	PH0	28	10
04717	PH1	28	10



## 7110M Universal holder, magnetic, style E 6.3.

Suitable for: For bits according to DIN 3126, ISO 1173 style C 4.  
 Drive: DIN 3126, ISO 1173, style E 6.3.  
 Application: Suitable for 4 mm bits, e.g. Wiha 7000-7005 series.  
 Extra: With magnet.

Order-No.	⊙	⊙	↔	🔧
32505	C4	1/4	60	10



## 7005 Z Standard bit, TORX®, style C 4.

Material: High grade chrome-vanadium steel, through hardened.  
 Drive: DIN 3126, ISO 1173, style C 4.  
 Application: For particularly small screws.

Order-No.	⊛	↔	🔧
20842	T3	28	10
20843	T4	28	10
04716	T5	28	10
04715	T6	28	10
04714	T7	28	10
04713	T8	28	10
04712	T9	28	10
04711	T10	28	10



Accessories for Wiha bits, style C 4.



**2691** SYSTEM 4 SoftFinish®-telescopic handle.  
Ergonomic multi-component handle with roll-off protection.

Handle: With 4 mm hex retainer for all SYSTEM 4 blades.  
Enables adjustable blade lengths from 18 - 90 mm.  
ClickStop ball clamp guarantees a secure hold and rapid blade exchange.  
Application: Ideal for all precision work in the fields of electronics and mechanics.

Order-No.	Hex	Length	Clamp	Weight
30373	4.0	105	23	10



**U759 00** SYSTEM 4 bit holder.  
Suitable for C 4 (4 mm) bits.

Blade: Chrome-vanadium steel, through hardened, electro-plated.

Order-No.	Hex	Length	Clamp	Weight
09195	4.0	135	4.0	9



**7000 EB16 ESD** SYSTEM 4 ESD bit set, 16 pcs.  
Mixed sets.

Handle: SYSTEM 4 SoftFinish®-telescopic ESD handle.  
ESD-safe (dissipative),  
surface resistance  $10^6 - 10^9$  ohms.  
Enables adjustable bit holder blade length.  
Standards: DIN 3126, ISO 1173, style C 4.  
IEC 61340-5-1.  
Case: No danger to electronic components with use of ESD-safe materials.  
Tough, space-saving metal box.  
Application: Bit set suitable for smallest screws with electronic components.  
Flexible working via adjustable blade length and rapid replacement of bit inserts.

Order-No.	Series	Weight
33503	7000 EB16 ESD	1
	<b>2691 ESD</b>	1xSYSTEM 4 SoftFinish®-telescopic ESD handle
	<b>U759 00</b>	1xSYSTEM 4 bit holder
⓪	<b>U750</b>	1x2.0    1x3.0
⊕	<b>U751</b>	1xPH000    1xPH00    1xPH0    1xPH1
⊗	<b>U757</b>	1xT3    1xT4    1xT5    1xT6
		1xT8
⦿	<b>U753</b>	1x0.9    1x1.3    1x1.5



**7000 EB26 ESD** SYSTEM 4 ESD bit set, 26 pcs.  
Mixed sets.

Handle: SYSTEM 4 SoftFinish®-telescopic ESD handle.  
ESD-safe (dissipative),  
surface resistance  $10^6 - 10^9$  ohms.  
Enables adjustable bit holder blade length.  
Standards: DIN 3126, ISO 1173, style C 4.  
IEC 61340-5-1.  
Case: No danger to electronic components with use of ESD-safe materials.  
Tough, space-saving metal box.  
Application: Universal set for especially small screws with electronic components.  
Flexible working via adjustable blade length and rapid replacement of bit inserts.

Order-No.	Series	Weight
33848	7000 EB26 ESD	1
	<b>2691 ESD</b>	1xSYSTEM 4 SoftFinish®-telescopic ESD handle
	<b>U759 00</b>	1xSYSTEM 4 bit holder
⓪	<b>U750</b>	1x1.5    1x2.0    1x3.0    1x4.0
⊕	<b>U751</b>	1xPH000    1xPH00    1xPH0    1xPH1
⊗	<b>U757</b>	1xT3    1xT4    1xT5    1xT6
		1xT7    1xT8    1xT9    1xT10
⦿	<b>U753</b>	1x0.7    1x0.9    1x1.3    1x1.5
		1x2.0    1x2.5    1x3.0    1x4.0

# Wiha bits for drive system C 8 (5/16") und G 7.

## Style C 8 (5/16").



### 7020 Z Standard bit, slotted, style C 8.

Material: High grade chrome-vanadium steel, through hardened.  
Drive: DIN 3126, ISO 1173, style C 8.

Order-No.	⌀	↔	⊖	↳
01741	5.5	41	0.8	10
01742	5.5	41	1.0	10
01744	6.5	41	1.2	10
01745	8.0	41	1.2	10
01746	8.0	41	1.6	10
01747	10.0	41	1.6	10
01748	12.0	41	2.0	10



### 7021 Z Standard bit, Phillips, style C 8.

Order-No.	⊕	↔	↳
01749	PH1	32	10
01750	PH2	32	10
01751	PH3	32	10
01753	PH4	38	10



### 7022 Z Standard bit, Pozidriv, style C 8.

Order-No.	⊕	↔	↳
01754	PZ1	32	10
01755	PZ2	32	10
01756	PZ3	32	10
01758	PZ4	38	10



### 7025 Z Standard bit, TORX®, style C 8.

Order-No.	⊗	↔	↳
01765	T25	35	10
01766	T27	35	10
01767	T30	35	10
01768	T40	35	10
01769	T45	35	10
01770	T50	35	10
01771	T55	35	10



### 7023 Z Standard bit, hex, style C 8.

Order-No.	⊙	↔	↳
01759	3.0	30	10
01760	4.0	30	10
01761	5.0	30	10
01762	6.0	30	10
01763	8.0	30	10
01764	10.0	30	10

## Style G 7.



### 7081 ZOT ZOT Torsion bit, Phillips, style G 7.

Material: High grade chrome-vanadium steel, through hardened.  
Geometry: Patented torsion zone to prevent premature breaking of the bit when under stress.  
Drive: DIN 3126, ISO 1173, style G 7.

Order-No.	⊕	↔	↳
04960	PH1	53	5
04961	PH2	53	5
04962	PH3	53	5



### 7082 ZOT ZOT Torsion bit, Pozidriv, style G 7.

Material: High grade chrome-vanadium steel, through hardened.  
Geometry: Patented torsion zone to prevent premature breaking of the bit when under stress.  
Drive: DIN 3126, ISO 1173, style G 7.

Order-No.	⊕	↔	↳
04553	PZ1	53	5
04552	PZ2	53	5
04551	PZ3	53	5



### 7183 Universal holder, magnetic/ retaining ring, style G 7.

Sleeve: Stainless steel.  
Suitable for: For bits according to DIN 3126, ISO 1173 style C 6.3.  
Drive: DIN 3126, ISO 1173, style G 7.  
Application: For applications where the bit must be held tight e.g. assembly lines.  
Extra: With strong Neodym magnet.

Order-No.	⊙	⊕	↔	↳
01919	1/4	G7	72	10

# Wiha CentroFix system.

Quick and professional.



Drilling, countersinking, driving screws and cutting threads is child's play with the Wiha CentroFix System. The innovative CentroFix quick-release holder forms the basis for a variety of hex-driven tools.

With CentroFix System, Wiha once again demonstrates that the user is central. The trend towards battery-powered drivers is continuing undiminished. Efficient models are greatly increasing the number of application areas and enabling more flexible working conditions. The Wiha CentroFix System also opens up these application areas to professional use.

With the CentroFix quick-release holder, Wiha closes the gap between the chuck of the battery-powered drivers and the quick-release holder for driver bits. The CentroFix holder allows rapid tool change, provides a secure fit and meets the more demanding requirements for concentricity and pull-off forces.



*Flexible, easy and quick – drill, countersink and turn screws with the Wiha CentroFix System for wood ...*

*... or with the Wiha CentroFix System for metal.*



**Wiha CentroFix system.**

#### Quick

- Saves time when changing tools

#### Secure

- Fixed connection between tool insert and holder

#### Zero-play

- For exact boreholes

#### Universal

- Fits all 1/4" hex drives

## CentroFix - one for all.



#### 7148C

CentroFix quick release holder, style E 6.3.

- Sleeve: Metal, coated.
- Suitable for: For bits according to DIN 3126, ISO 1173 style C 6.3 and E 6.3.
- Drive: DIN 3126, ISO 1173, style E 6.3.
- Packaging: Plastic box, reusable.
- Application: Whenever the bit needs a secure and zero-play hold. Optimised for the use of drill bits. Ideal for Torx bits.
- Extra: Due to the special holding mechanism, this bit holder holds all types of bits with 1/4" hex drive. The play between bit and holder is reduced to a minimum. Single-handed operation for fast bit exchange.

Order-No.	○	●	⊖	⊕
32477	1/4	1/4	60	10

# Wiha drill bits.

Just keep on working.

## Wood twist drill bit.



### 7804 Wood twist drill bit, style C 6.3.

**Material:** High grade chrome-molybdenum steel, ground.  
**Packaging:** Blister packed.  
**Drive:** With 1/4" hex shank according to DIN 3126 C 6.3.  
**Application:** Especially suitable for boreholes in soft and hardwoods, as well as in veneered and coated laminated materials.  
**Extra:** By means of careful rough-cutting, drilling of pocket holes is easy and does not tear the material.  
 With centring tip for exact drilling.  
 Particularly suitable for use in battery-powered drivers.

Order-No.	⊗	↔	↔	⊙	☰
27873	3.0	70	36	1/4	10
27876	4.0	75	43	1/4	10
27877	5.0	85	56	1/4	10
27879	6.0	95	66	1/4	10
27880	8.0	110	81	1/4	10
27881	10.0	110	81	1/4	10



### 79184 T19 Wood twist drill set, 19 pcs.

**Pouch:** High-quality nylon pouch, 13 x 2 x 10 cm.  
**Bits:** 25 mm Standard and Torsion bits, wood twist drill bits, countersink bit.  
**Bit holder:** CentroFix quick release holder, magnetic, style E 6.3.  
**Application:** Compact range for drilling, countersinking and driving screws in wood.  
**Extra:** Pouch with sturdy metal belt clip.

Order-No.	Series	☰			
28024	79184 T19	1			
⊗	7804	1x3.0	1x4.0	1x5.0	1x6.0
		1x8.0			
⊙	7806	1x12.4			
⊕	7011 ZOT	1xPH2			
⊕	7012 ZOT	1xPZ1	3xPZ2	1xPZ3	
⊗	7015 Z	1xT15	1xT20	1xT25	1xT30
⊙	7019 Z SIT	1xSIT 20	1xSIT 30		
	7148C	1xCentroFix quick release holder, style E 6.3			

### 7918 TL Nylon pouch, empty.

Order-No.	Series	☰
28028	7918 TL	1

## Twist drill bit.



### 7805 Twist drill bit, style C 6.3.

**Material:** High-quality HSS steel, ground.  
**Packaging:** Blister packed.  
**Drive:** With 1/4" hex shank according to DIN 3126 C 6.3.  
**Application:** Universal application in metal, plastic and wood.  
**Extra:** Particularly suitable for use in battery-powered drivers.  
 Special rivet-hole sizes 3.1, 4.1 and 5.1.

Order-No.	⊗	↔	↔	⊙	☰
27882	3.0	38	16	1/4	10
28055	3.1	38	16	1/4	10
27883	3.3	40	18	1/4	10
27884	4.0	43	22	1/4	10
28056	4.1	43	22	1/4	10
27885	4.2	43	22	1/4	10
27886	5.0	48	26	1/4	10
28057	5.1	48	26	1/4	10
27887	6.0	48	26	1/4	10
27888	6.8	48	30	1/4	10
27889	8.0	50	32	1/4	10
27890	8.5	51	34	1/4	10
27891	10.0	54	37	1/4	10



### 79185 T19 Twist drill set, 19 pcs.

**Pouch:** High-quality nylon pouch, 13 x 2 x 10 cm.  
**Bits:** 25 mm Standard and Torsion bits, twist drill bits.  
**Bit holder:** CentroFix quick release holder, magnetic, style E 6.3.  
**Application:** Compact assortment for universal application when driving screws.  
**Extra:** Pouch with sturdy metal belt clip.

Order-No.	Series	☰			
28025	79185 T19	1			
⊗	7805	1x3.0	1x4.0	1x4.2	1x5.0
		1x6.0	1x8.0		
⊕	7011 ZOT	2xPH1	3xPH2	1xPH3	
⊕	7012 ZOT	2xPZ2			
⊗	7015 Z	1xT15	1xT20	1xT25	1xT30
	7148C	1xCentroFix quick release holder, style E 6.3			

### Combination drill bit and universal drill bit.



#### 7807 Combination drill bit, style C 6.3.

Material: High-quality HSS steel, ground.  
 Packaging: Blister packed.  
 Drive: With 1/4" hex shank according to DIN 3126 C 6.3.  
 Application: Drilling, cutting threads and burring. For assembly work, repair and rethreading.  
 Can be used in metal and plastic.  
 Extra: Three applications in a single work step. Particularly suitable for use in battery-powered drivers.

Order-No.	⊙	↔	⊙↑	↔
27897	M3	36	1/4	10
27898	M4	39	1/4	10
27899	M5	41	1/4	10
27900	M6	44	1/4	10
27901	M8	51	1/4	10
27963	M10	65	1/4	10

### Countersink bit and bit holder.



#### 7806 Countersink bit, style C 6.3.

Material: High-quality HSS steel, ground.  
 Packaging: Blister packed.  
 Drive: With 1/4" hex shank according to DIN 3126 C 6.3.  
 Application: Universal application in metal, plastic and wood.  
 Extra: Particularly suitable for use in battery-powered drivers.  
 Guarantees outstanding removal of cuttings, no-rattle operation and smooth surface.

Order-No.	↻	↔	⊙↑	⊙	∅ min.	↔
27892	6.3	35	1/4	M3	1.5	10
27893	8.3	35	1/4	M4	2.0	10
27894	10.4	35	1/4	M5	2.5	10
27895	12.4	35	1/4	M6	2.8	10
27896	16.5	35	1/4	M8	3.2	10
28058	20.5	35	1/4	M10	3.5	10



#### 79187 B5 Combination drill bit set, 5 pcs.

Order-No.	Series	↔
28026	79187 B5	1
⊙	7807	M3x36 M4x39 M5x41 M6x44 M8x51



#### 79186 B5 Countersink set, 5 pcs.

Order-No.	Series	↔
28027	79186 B5	1
↻	7806	6.3x35 8.3x35 10.4x35 12.4x35 16.5x35



#### 7848 Universal drill bit, style E 6.3.

Material: High-quality HSS steel, ground.  
 Packaging: Blister packed.  
 Drive: 1/4" hex universal drill in accordance with DIN 3126, style E 6.3.  
 Application: For use in (battery-powered) screwdrivers; suitable for drilling holes in a multitude of materials (light masonry, light building materials, non-ferrous metal, metal, wood, plastics etc.) as well as light drilling on smooth and hard surfaces.  
 Extra: Exact drilled holes via the special cutting edge.  
 Especially long service life.

Order-No.	⊗	↔	↔	⊙↑	↔
32292	4	85	45	1/4	10
32293	5	96	50	1/4	10
32294	6	101	60	1/4	10
32295	7	101	60	1/4	10
32296	8	120	70	1/4	10
32297	10	120	70	1/4	10



#### 281-02 Bit holder with handle, magnetic, 1/4".

Handle: Wiha SoftFinish® multi-component handle with roll-off protection.  
 Bit holder: Stainless steel with strong magnet.  
 Suitable for: For bits according to DIN 3126, ISO 1173 style C 6.3 and E 6.3.  
 Application: Compact screwdriver together with bits, 1/4".  
 Together with Wiha countersink bits, can be used as manual deburrer.

Order-No.	⊙	↔	↔	↔
32160	1/4	125	36	10



# Wiha power nut driver product line.

The entire line for hand and machine use.



For those who place high demands in their tools: the extensive Wiha nut driver product line for hand and machine operation will definitely satisfy.

The high quality power nut driver inserts for example stand up to especially heavy loading. Another advantage is their hexagon opening with rounded corners: It grasps even flat bolts easily and extremely gently. With the incorporated permanent magnet and optional bit holder, particular attention was also paid to practical, user-friendly details.

A remedy for tough cases: The new hand impact screwdriver with hand protection and a changeover function is a specialist for jammed bolts and nuts. The matching 5/16" bits for PH, slotted and TORX® drives are produced of special chrome vanadium steel and through-hardened, making them especially impact and break-resistant.



The jack-of-all-trades product line is rounded off with universal connection pieces, parts and smooth-running ratchets. With a universal joint (connection pieces) and a locking button (ratchets) for holding or quickly releasing the attached tools, they're excellently equipped for working in hard-to-reach places. The 3-component handle (SoftFinish®) of the ratchets also guarantees comfortable, safe use.

Whether tools or accessories, whether its hand or machine-operated nut drivers: With this versatile assortment the user is also equipped for difficult and special cases.



## Wiha power nut driver product line.

- Extensive application possibilities and large range of tools for electric and pneumatic screwdrivers as well as hand-operated nut driver inserts
- Nut driver inserts (1/4" drive) in high-quality special chrome vanadium steel; also available with incorporated permanent magnet that safely guides the screws when installing
- Hand impact screwdriver with hardened, lacquered impact end against chipping of chrome parts or mushroom-shaped deformations

## Machine-operated nut driver inserts.

**7244** Power nut driver insert, hex - style E 6.3.

Material: High-quality chrome vanadium alloy steel, through-hardened, phosphate coated surface.

Drive: DIN 3126, ISO 1173, style E 6.3.

Application: For mechanical fastening and unfastening.

Extra: Rounded hex opening in the corners for protection of the screw heads.

Order-No.	Ø	Ø	Ø	Ø
32513	5.5	9	50	5
32514	7	11	50	5
32515	8	12	50	5
32516	10	14	50	5
32517	12	17	50	5
32518	13	18	50	5
32519	1/4	10	50	5

**7244M** Power nut driver insert, hex with magnet - style E 6.3.

Material: High-quality chrome vanadium alloy steel, through-hardened, phosphate coated surface.

Drive: DIN 3126, ISO 1173, style E 6.3.

Application: For mechanical fastening and unfastening.

Extra: With a powerful permanent magnet embedded in brass.  
Rounded hex opening in the corners for protection of the screw heads.

Order-No.	Ø	Ø	Ø	Ø
32520	5.5	9	50	5
32521	6	10	50	5
32522	7	11	50	5
32523	8	12	50	5
32524	10	14	50	5
32525	12	17	50	5
32526	13	18	50	5
32528	1/4	10	50	5
32530	5/16	12	50	5
32529	3/8	14	50	5
32527	1/2	17	50	5

## Machine-operated nut driver inserts.

**7204** Power hex nut driver, 1/4" drive.

Material: High-quality chrome-molybdenum steel, through-hardened, phosphate coated surface.

Drive: DIN 3129, ISO 2725-2.

Application: For tightening and loosening hex screws with electric or pneumatic screwdrivers (rotary or impact screwdrivers).

Extra: Rounded hex opening in the corners for protection of the screw heads.

Order-No.	Ø	Ø	Ø	Ø	Ø
32531	5.5	9,4	13	23	1
32532	6	10,0	13	23	1
32533	7	11,3	13	23	1
32534	8	12,5	13	23	1
32535	10	15,0	13	23	1
32536	12	17,5	13	23	1
32537	13	18,8	13	23	1
32538	1/4	10,0	13	23	1
32539	5/16	12,5	13	23	1
32540	3/8	15,0	13	23	1

**7204M** Power hex nut driver with magnet, 1/4" drive.

Material: High-quality chrome-molybdenum steel, through-hardened, phosphate coated surface.

Drive: DIN 3129, ISO 2725-2.

Application: Mainly for fastening and unfastening in self-tapping sheet metal screws with electric or pneumatic screwdrivers (rotary or impact screwdrivers).  
The magnet simplifies the guidance of the screws while fastening.

Extra: With a powerful permanent magnet embedded in brass.  
With 0.03 mm raised cladding in comparison to the standard model for a considerably increased service life.  
Due to the rounded hex opening, flat screws can easily be gripped.

Order-No.	Ø	Ø	Ø	Ø	Ø
32541	7	11,6	13	23	1
32542	8	12,8	13	25	1
32543	10	15,3	13	28	1
32544	13	19,1	13	30	1
32545	1/4	10,3	13	23	1

**7205** Power TORX® nut driver insert, 1/4" drive.

Material: High-quality chrome-molybdenum steel, through-hardened, phosphate coated surface.

Drive: DIN 3129.

Application: For external TORX® screws and self-tapping screws with TORX® head.  
Suitable for electric or pneumatic screwdrivers (rotary or impact screwdrivers).

Order-No.	Ø	Ø	Ø	Ø
32550	E6	8,7	13	23
32551	E8	9,2	13	23
32552	E10	12,2	13	23

# Wiha power nut driver product line.

The entire line for hand and machine use.

## For nut driver inserts.



### 7241Z Power connection piece with ball.

Standards: External square drive in accordance with DIN 3120.  
 Material: High-quality chrome vanadium alloy steel, through-hardened, phosphate coated surface.  
 Drive: DIN 3126, ISO 1173, style E 6.3.  
 Application: For use with machine-operated nut drivers.

Order-No.				
32508	1/4	1/4	35	5
32509	1/4	1/4	50	5
32510	1/4	1/4	100	5
32511	3/8	1/4	50	5
32512	1/2	1/4	60	5



### 24633 Power universal joint with ball (machine operation).

Material: High-quality chrome-molybdenum steel, through-hardened, phosphate coated surface.  
 Drive: DIN 3121.  
 Application: Makes working in hard-to-reach places easier in connection with machine-operated nut drivers.  
 Extra: 1/4" insert with ball and joint.

Order-No.				
32553	1/4	1/4	39	1



### 24634 Power extension piece.

Material: High-quality chrome-molybdenum steel, through-hardened, phosphate coated surface.  
 Drive: DIN 3121.  
 Application: Extension for machine-operated nut driver.  
 Extra: 1/4" insert.

Order-No.				
32554	1/4	1/4	75	1

## Bit holder and nut driver set.



### 7204Z Power bit holder.

Material: High-quality chrome-molybdenum steel, through-hardened, phosphate coated surface.  
 Drive: DIN 3126.  
 Application: For use of C 6.3 bits.

Order-No.				
32546	1/4	1/4	36	1
32548	1/4	3/8	40	1
32549	1/4	1/2	48	1



### 7204 K39 Complete nut driver and bit set for hand and machine use, 37 pcs.

Case: Made of high-quality plastic with foam insert.  
 Content:

#### Hand use:

- 24630 ratchets, 1/4" with SoftFinish® handle
- 24632 T-handle
- 24635 universal joint
- 24637 bit holder for C 6.3 bits
- 7011Z PH1, PH2, PH3
- 7012Z PZ1, PZ2, PZ3
- 7015Z T10, T15, T20, T25, T30
- 28101 Stubby with magnet

#### Machine use:

- 7244M with magnet, size 6, 8, 10
- 7241Z connection piece, 50 mm
- 24634 extension piece
- 72050 TORX® nut driver E6, E8, E10
- 72040 hex nut driver, size 5.5, 6, 7, 8, 10, 12, 13 mm
- 7204Z bit holder for E 6.3 bits
- 7045Z T10, T15, T20, T25, T30

Contents: Nut driver and bits for hand and machine use.

Order-No.	Series	
32818	7204 K39	1

## Machine-operated nut driver inserts.

**7044** Standard bit, socket-wrench insert, style E 6.3.

Material: High grade chrome-vanadium steel, through hardened.

Drive: DIN 3126, ISO 1173, style E 6.3.

Application: For all types of screw applications in trade and industry.

Order-No.	Ø	→	←
04514	5.0	55	5
04513	5.5	55	5
04512	6.0	55	5
04511	7.0	55	5
04510	8.0	55	5
04509	10.0	55	5
04508	13.0	55	5
04515	1/4	55	5
04516	5/16	55	5
04517	3/8	55	5

**7044 M** Standard bit, nut driver insert, magnetic, style E 6.3.

Application: For all types of screw applications in trade and industry.

Extra: With strong permanent magnet.

Order-No.	Ø	→	←
04637	5.0	55	5
04636	5.5	55	5
04635	6.0	55	5
04634	7.0	55	5
04633	8.0	55	5
04632	10.0	55	5
04631	13.0	55	5
04638	1/4	55	5
04639	5/16	55	5
04640	3/8	55	5

**24632** T-handle.

Material: High-quality chrome-molybdenum steel, through-hardened, chrome-plated and polished.

Drive: DIN 3120.

Application: For hand used nut driver sockets.

Order-No.	Ø	→	←
32557	1/4	115	1

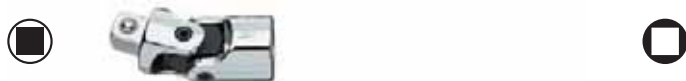
**24635** Universal joint (hand operation).

Material: High-quality chrome-molybdenum steel, through-hardened, chrome-plated and polished.

Drive: DIN 3123.

Application: For working in hard-to-reach places with hand-operated nut drivers.

Extra: Easier joint operation.

Order-No.	Ø	Ø	→	←
32555	1/4	1/4	33	1

## For nut driver inserts and bits

**24630** Ratchet with SoftFinish handle.

Design: Ratchet wheel with 20 teeth, extremely smooth-running and resilient. With proven Wiha SoftFinish® multi-component handle for more safety when working.

Material: High-quality chrome-molybdenum steel, through-hardened, chrome-plated and polished.

Drive: DIN 3122, style D 6.3.

Application: For hand-operated nut driver inserts.

Extra: The locking button ensures secure holding of the nut driver and quick release of the attached tool.

Order-No.	Ø	→	←
32629	1/4	140	1

**24631** Ratchet with joint and SoftFinish handle.

Design: Ratchet wheel with 20 teeth, extremely smooth-running and resilient. With proven Wiha SoftFinish® multi-component handle for more safety when working.

Material: High-quality chrome-molybdenum steel, through-hardened, chrome-plated and polished.

Drive: DIN 3122, style D 6.3.

Application: The articulated head makes working in hard-to-reach places with nut drivers easier.

Extra: The locking button ensures secure holding of the nut driver and quick release of the attached tool.

Order-No.	Ø	→	←
32630	1/4	165	1

**SB 2463 001** 1/4" bit ratchet, with thumb wheel. Blister packed for hanging.

Design: Drop forged, especially robust version. Maximum ergonomics due to user-specific SoftFinish form. Finely serrated ratchet mechanism with 72 teeth. Clockwise and anticlockwise direction can be switched via switching lever. with practical thumb wheel.

Bit holder: For bits according to DIN 3126, ISO1173, style C 6.3 and E 6.3.

Material: High-quality chrome-molybdenum steel, chrome-plated and satin finished.

Application: Especially handy bit ratchet for a wide variety of fastening applications. Minimum switching angle of only 5° enables use of bit ratchet even in the tightest spaces.

Due to outstandingly smooth running the mechanism functions even when other ratchets fail, e.g. with furniture assembly.

Extra: Thumb-wheel aids applying, fastening and releasing screws.

Order-No.	Ø	→	←
36931	1/4	90	5

# Wiha adapters.

## For nut driver inserts and bits



### 7210 Tool shaft, style C 6.3.

Suitable for: DIN 3120, ISO 1174, style A 6.3 + A 10.  
 Drive: DIN 3126, ISO 1173, style C 6.3.  
 Application: For hand used nut driver sockets.

Order-No.				
01933	1/4	1/4	25	5
04204	3/8	1/4	30	5

## For machine used nut driver sockets.



### 7230 Tool shaft, style A 5.5.

Standards: Adapter DIN 7428.  
 Suitable for: DIN 3121, ISO 1174, style F 6.3.  
 Drive: DIN 3126, ISO 1173, style A 5.5.  
 Application: For machine used nut driver sockets.

Order-No.				
01934	1/4	5.5	50	5



### 7201 Connecting device with retaining ring, style G 6.3 + G 10 + G 12.5.

Suitable for: DIN 3126, ISO 1173, style D 6.3 and D 8.  
 Drive: DIN 3121, ISO 1174, style G 6.3 + G 10 + G 12.5.  
 Application: Suitable for bits C 6.3 and C 8.

Order-No.							
01924	1/4	1/4	25	D 6.3			2
01926	1/4	3/8	30	D 6.3			2
01922	1/4	1/2	35	D 6.3			2
01927	5/16	3/8	30	D 8			2
01923	5/16	1/2	35	D 8			2



### 7240 Tool shaft, style E 6.3.

Standards: Adapter DIN 7428.  
 Suitable for: DIN 3121, ISO 1174, style F 6.3 and F 10.  
 Drive: DIN 3126, ISO 1173, style E 6.3.  
 Packaging: Plastic box, reusable and dust repellent.  
 Application: For machine used nut driver sockets.  
 Extra: Easily identifiable content with large symbols.

Order-No.				
04685	1/4	1/4	100	5
01935	1/4	1/4	50	5
04684	3/8	1/4	100	5
04362	3/8	1/4	50	5



**NEW**

### 7203 Connector, style G 12.5 with quick release chuck.

Sleeve: Steel, hardened.  
 Suitable for: For bits according to DIN 3126, ISO 1173 style C 6.3.  
 Drive: 1/2" internal square-drive in accordance with DIN 3126, ISO 1174, style G 12.5.  
 Application: For use of C 6.3 bits.  
 Extra: The alternative to G 12.5 bits.

Order-No.				
01930	1/4	1/2	50	2



### 7280 Tool shaft, style G 7.

Suitable for: DIN 3121, ISO 1174, style F 6.3.  
 Drive: DIN 3126, ISO 1173, style G 7.  
 Application: For machine used nut driver sockets.

Order-No.				
01936	1/4	7	75	5



### 24637 Power bit holder.

Material: High-quality chrome-molybdenum steel, through-hardened, chrome-plated and polished.  
 Drive: DIN 3126.  
 Application: For use of C 6.3 bits.

Order-No.				
33230	1/4	1/4	22	1



# Wiha impact screwdriver assortment.

The complete range.

## Impact screwdriver and bits.



### 7050 5/16" impact screwdriver bits, slotted.

Material: High-quality chrome-molybdenum steel, through-hardened, phosphate coated surface.

Drive: DIN 3126, ISO 1173, style C 8.

Application: For slotted screws for use in impact screwdrivers.

Extra: Especially impact-resistant.

Order-No.	①	⊕	⊖	↔	↔
32561	9	1.6	5/16	32	5
32562	11	1.6	5/16	32	5
32563	14	2.0	5/16	32	5



### 7051 5/16" impact screwdriver bits, Phillips.

Material: High-quality chrome-molybdenum steel, through-hardened, phosphate coated surface.

Drive: DIN 3126, ISO 1173, style C 8.

Application: For Phillips screws for use in impact screwdrivers.

Extra: Especially impact-resistant.

Order-No.	⊕	⊖	↔	↔
32558	PH2	5/16	32	5
32559	PH3	5/16	32	5
32560	PH4	5/16	32	5



### 7055 5/16" impact screwdriver bits, TORX®.

Material: High-quality chrome-molybdenum steel, through-hardened, phosphate coated surface.

Drive: DIN 3126, ISO 1173, style C 8.

Application: For TORX® screws for use in impact screwdrivers.

Extra: Especially impact-resistant.

Order-No.	⊕	⊖	↔	↔
32564	T30	5/16	32	5
32565	T40	5/16	32	5
32566	T45	5/16	32	5
32567	T50	5/16	32	5

## Impact screwdriver and bits.



### 24636 1/2" hand impact screwdriver.

Material: High-quality chrome-molybdenum steel, through-hardened, with hand protection.

Drive: Square 1/2".

Application: For loosening jammed screws or nuts together with the Wiha 5/16" impact bits and holder.

Maximum transmissible torque of up to 200 Nm.

Extra: The insert is hardened and lacquered at the impact end to prevent the chipping of chrome parts or mushroom-shaped deformations.

Note: Can only be used with adapter 72040 (5/16" to 1/2")

Order-No.	⊖	↔	↔
32556	1/2	163	1



### 7204Z-516 Power bit holder.

Material: High-quality chrome-molybdenum steel, through-hardened, chrome-plated and polished.

Drive: DIN 3120.

Application: For use of C 8 bits.

Required for use with hand impact screwdriver, series 24636.

Order-No.	⊖	⊕	↔	↔
32547	5/16	1/2	38	1



### 24636 B5 1/2" hand impact screwdriver set with 5/16" bits and bit holder, 6 pcs.

Material: High-quality chrome-molybdenum steel, through-hardened, with hand protection.

Drive: Square 1/2", also suitable for 5/16" bits with adapter.

Application: For loosening jammed screws or nuts together with the Wiha 5/16" impact bits and holder.

Maximum transmissible torque of up to 200 Nm.

Extra: The insert is hardened and lacquered at the impact end to prevent the chipping of chrome parts or mushroom-shaped deformations.

Order-No.	Series	↔
32573	24636 B5	1
⊖	24636	1/2" hand impact screwdriver
①	7050	9x1.6 11x1.6
⊕	7051	PH2x5/16 PH3x5/16
	7204Z-516	Bitholder

# Wiha Gripper.

Sizes everything.

## Gripper.



### 9246 01 Gripper nut driver 3/8".

**Material:** Housing made from alloyed steel.  
54 spring-loaded hardened steel pins.

**Drive:** DIN 3120, style C 10.

**Application:** Replaces nuts from 7 mm to 19 mm.  
Regardless of whether inch or metric dimensions.  
The 54 steel pins fit every nut or screw with an external profile.  
For screws up to a height of 8 mm.

**Extra:** The Gripper also works on hooks or eyebolts.  
Enables a torque transmission of up to 80 Nm.

Order-No.				
09400	3/8	25.4	53.5	10

### SB 246 01 Gripper nut driver insert, 3/8".

**Blister packed.**

**Material:** Housing made from alloyed steel.  
54 spring-loaded hardened steel pins.

**Drive:** DIN 3120, style C 10.

**Application:** Replaces nuts from 7 mm to 19 mm.  
Regardless of whether inch or metric dimensions.  
The 54 steel pins fit every nut or screw with an external profile.  
For screws up to a height of 8 mm.

**Extra:** The Gripper also works on hooks or eyebolts.  
Enables a torque transmission of up to 80 Nm.

Order-No.				
20554	3/8	25.4	53.5	10

## Gripper compact set.



### SB 246 02 Gripper compact set, 3 pcs.

**Consists of Gripper nut driver, ratchet 3/8" and adapter for portable electric drills.**

**Blister packed.**

**Material:** Housing made from alloyed steel.  
54 spring-loaded hardened steel pins.

**Drive:** DIN 3120, style C 10.

**Content:** Gripper nut driver 3/8"  
Ratchet 3/8"  
Adapter 3/8"

**Application:** Replaces nuts from 7 mm to 19 mm.  
Regardless of whether inch or metric dimensions.  
The 54 steel pins fit every nut or screw with an external profile.  
For screws up to a height of 8 mm.

**Extra:** The Gripper also works on hooks or eyebolts.  
Enables a torque transmission of up to 80 Nm.

Order-No.	Series	
20783	SB 246 02	1
	9246 01	Gripper nut driver 3/8"
	246 05	Ratchet 3/8"
	246 03	Adapter 3/8"

# Wiha bit holder.

For rapid changing of bits without tools.



CentroFix bit holders are characterised by particular user friendliness.

The bit is automatically locked when it is inserted. When unlocked it moves forward several millimetres and can be removed easily.

Ideal for powerful users- the CentroFix Force was designed to be particularly stable. The CentroFix SuperSlim shows off its thin design.

The new MagicFlip Force is perfectly suited for hard jobs thanks to its robust operating sleeve of steel. With its strong Neodym ring magnet it even securely holds heavy screws.



## Wiha CentroFix Force

- Suitable for all bits with 1/4" hex drive Style C6.3 and E6.3
- Operating sleeve of robust, hardened steel
- SelfLock  
The bit is locked mechanically and held securely when inserted
- EasyOut  
When unlocked, the bit moves into the ideal removal position



## Wiha CentroFix Super Slim

- Up to 30% reduced outer diameter compared to "conventional" quick release holders
- Screw accessibility is better in confined holes
- SelfLock  
The bit is locked mechanically and held securely when inserted
- EasyOut  
When unlocked, the bit moves into the ideal removal position



## Wiha MagicFlip Force

- Extremely strong Neodym ring magnet, holding force 16N (approx. 1.6 Kg)
- New – also suitable for drywall screws with small screw heads
- New – operating sleeve of robust steel
- FlipBack  
the operating sleeve automatically springs back during recessing.
- Magnet On/Off  
The ring magnet can be "deactivated" by pushing the operating sleeve back

# Wiha bit holder for power machines.

For rapid changing of bits without tools.

## Drive system style E 6.3.



NEW

### 7148 CF CentroFix Force quick release holder, magnetic, style E 6.3.

Sleeve: Steel hardened, coated.  
 Suitable for: For bits according to DIN 3126, ISO 1173 style C 6.3 and E 6.3.  
 Drive: DIN 3126, ISO 1173, style E 6.3.  
 Packaging: Plastic box, reusable.  
 Application: Whenever the bit needs a secure and zero-play hold. Ideal for screw profiles (e.g. Torx) which tend to jam in the screw.  
 Extra: Bit is automatically locked when inserted - SelfLock. Simple bit removal thanks to EasyOut ejection function. Robust operating sleeve of hardened steel. With strong Neodym magnet.

Order-No.	Ø	⊙	↔	↳
39133	1/4	1/4	60	10

## Drive system style E 6.3.



### 7148ST CentroFix stainless steel quick release holder, style E 6.3. Blister packed.

Sleeve: Of high-quality, non-rusting stainless steel, therefore recommended for use with stainless steel bits.  
 Suitable for: DIN 3126, ISO 1173, style D 6.3 + F 6.3 and double bits.  
 Drive: DIN 3126, ISO 1173, style E 6.3.  
 Application: Whenever the bit needs a secure and zero-play hold. Optimised for the use of long bits.  
 Extra: Due to the special holding mechanism, this bit holder holds all types of bits with 1/4" hex drive. The play between bit and holder is reduced to a minimum. Single-handed operation for fast bit exchange.

Order-No.	Ø	⊙	↔	↳
33765	1/4	1/4	60	10



NEW

### 7148 CS CentroFix SuperSlim quick release holder, magnetic, style E 6.3.

Sleeve: Stainless steel.  
 Suitable for: For bits according to DIN 3126, ISO 1173 style C 6.3 and E 6.3.  
 Drive: DIN 3126, ISO 1173, style E 6.3.  
 Packaging: Plastic box, reusable.  
 Application: Particularly suitable for applications in confined working environments. Ideal for screw profiles (e.g. Torx) which tend to jam in the screw.  
 Extra: Bit is automatically locked when inserted - SelfLock. Simple bit removal thanks to EasyOut ejection function. Robust operating sleeve of aluminium. With strong Neodym magnet.

Order-No.	Ø	⊙	↔	↳
39134	1/4	1/4	66	10



### 7143 Universal holder, magnetic/ retaining ring, style E 6.3.

Sleeve: Stainless steel.  
 Suitable for: For bits according to DIN 3126, ISO 1173 style C 6.3.  
 Drive: DIN 3126, ISO 1173, style E 6.3.  
 Application: For applications where the bit must be held tight e.g. assembly lines.

Order-No.	Ø	⊙	↔	↳
01913	1/4	1/4	72	10
36092	1/4	1/4	100	5
34306	1/4	1/4	150	5
36093	1/4	1/4	200	5
36094	1/4	1/4	250	5



NEW

### 7123 MagicFlip Force universal holder with ring magnet, style E 6.3.

Sleeve: Steel hardened, coated.  
 Suitable for: For bits according to DIN 3126, ISO 1173 style C 6.3 and E 6.3.  
 Drive: DIN 3126, ISO 1173, style E 6.3.  
 Packaging: Plastic box, reusable.  
 Application: The strong Neodym ring magnet even holds long screws securely. Enables easy fastening of screws.  
 Extra: With strong Neodym magnet. Particularly small ring magnet inner diameter, also suitable for drywall screws. Ring magnet sleeve springs back to the last fastening phase, allowing a view of the screw head and enabling precise recessing. Ring magnet sleeve can be pushed back and thus "deactivated" if required.

Order-No.	Ø	⊙	↔	↳
36800	1/4	1/4	62	10



### 7142 Universal holder, magnetic/ retaining ring, style E 6.3.

Sleeve: Copper beryllium.  
 Suitable for: For bits according to DIN 3126, ISO 1173 style C 6.3.  
 Drive: DIN 3126, ISO 1173, style E 6.3.  
 Application: Copper-beryllium alloys prevent ignitable sparks and reduce the danger of explosion. Tools made of copper-beryllium are often used in potentially explosive areas.

Order-No.	Ø	⊙	↔	↳
01912	1/4	1/4	73	10



### 7140 Universal holder, with retaining ring, style E 6.3.

Suitable for: For bits according to DIN 3126, ISO 1173 style C 6.3.  
 Drive: DIN 3126, ISO 1173, style E 6.3.  
 Application: For applications where the bit must be held tight e.g. assembly lines.  
 Extra: One piece construction.

Order-No.	Ø	⊙	↔	↳
01910	1/4	1/4	57	10

Drive system style E 6.3, G 7, SDS-Plus® and Halfmoon.



**7113** Universal holder, magnetic, style E 6.3.

Sleeve: Stainless steel.  
 Suitable for: For bits according to DIN 3126, ISO 1173 style C 6.3.  
 Drive: DIN 3126, ISO 1173, style E 6.3.  
 Packaging: Plastic box, reusable and dust repellent.  
 Extra: Easily identifiable content with large symbols.  
 With strong Neodym magnet.

Order-No.				
01894	1/4	1/4	50	10



**7113 S** Universal holder, magnetic, style E 6.3.

Sleeve: Stainless steel.  
 Suitable for: For bits according to DIN 3126, ISO 1173 style C 6.3.  
 Drive: DIN 3126, ISO 1173, style E 6.3.  
 Extra: With strong Neodym magnet.

Order-No.				
01895	1/4	1/4	58	10



**7183** Universal holder, magnetic/retaining ring, style G 7.

Sleeve: Stainless steel.  
 Suitable for: For bits according to DIN 3126, ISO 1173 style C 6.3.  
 Drive: DIN 3126, ISO 1173, style G 7.  
 Application: For applications where the bit must be held tight e.g. assembly lines.  
 Extra: With strong Neodym magnet.

Order-No.				
01919	1/4	G7	72	10



**7180-7** Quick release holder, magnetic, SDS-Plus®.

Suitable for: For bits according to DIN 3126, ISO 1173 style C 6.3.  
 Drive: SDS-Plus®.  
 Application: All hammer drills become powerful screwdrivers with this bit holder.  
 Extra: With strong Neodym magnet.

Order-No.			
26255	1/4	SDS-Plus®	100



**NEW**  
**7110 HM** Industrial bit holder, with magnet, Halfmoon 4 mm.

Sleeve: Steel, hardened.  
 Suitable for: For bits according to DIN 3126, ISO 1173 style C 4.  
 Drive: Halfmoon, 4mm.  
 Application: Facilitates use of C4 bits (4mm) in screwdrivers with Halfmoon insertion.  
 Extra: Manufactured from a single piece of steel, with good rotation characteristics. With strong Neodym magnet. The alternative to Halfmoon bits.

Order-No.				
36112	1/4	1/4	50	10

Bit holder sales counter display.



**7123R VB1** MagicFlip display, 30-pcs.  
 Acryl glass display with 30 pieces.

Size: 22 x 19 x 35 cm (WxDxH).

Order-No.	Series	
36930	7123R VB1	
7123	30 x MagicFlip Force universal holder with ring magnet style E 6.3	

**7149 VB06** Bit holder display.  
 Acryl glass display with 30 pieces.

Size: 22 x 15 x 32 cm (WxDxH).

Order-No.	Series	
36161	7149 VB06	1
7113 S	10 x Universal holder 58 mm magnetic	
7148 CF	5 x CentroForce quick release holder	
7143	5 x Universal holder 72 mm magnetic	
7148 CS	10 x CentroFix SuperSlim quick release holder magnetic	



**7143 VB1** Bit holder display.  
 Acryl glass display with 70 pieces.

Size: 22 x 19 x 35 cm (WxDxH).

Order-No.	Series	
36384	7143 VB1	1
7113 S	20 x Universal holder 58 mm magnetic	
7110 HM	20 x Universal holder 74 mm magnetic	
7143	10 x Universal holder 100 mm magnetic	
	10 x Universal holder 150 mm magnetic	
	10 x Universal holder 200 mm magnetic	



# Wiha Bit holder with handle.

## Bit holder 1/4".



### 384 Bit holder with handle, magnetic, 1/4".

Blade: Chrome-vanadium steel, through hardened, nickel-plated.  
 Handle: Wiha SoftFinish® multi-component handle with roll-off protection.  
 Bit holder: Stainless steel with strong magnet.  
 Suitable for: For bits according to DIN 3126, ISO 1173 style C 6.3.

Order-No.	Ø	↔	↔	↕	↔
01475	1/4	125	225	36	10
01476	1/4	300	400	36	5



### 386 Bit holder with handle, flexible shaft, 1/4".

Blade: Plastic coated flexible metal.  
 Handle: Wiha SoftFinish® multi-component handle with roll-off protection.  
 Bit holder: With retaining ring.  
 Suitable for: For bits according to DIN 3126, ISO 1173 style C 6.3.  
 Application: For offset screws.

Order-No.	Ø	↔	↔	↕	↔
01479	1/4	150	268	36	10



### 387 Bit holder with handle, quick release holder, 1/4".

Handle: Wiha SoftFinish® multi-component handle with roll-off protection.  
 Bit holder: ClicFix quick release holder, magnetic.  
 Suitable for: For bits according to DIN 3126, ISO 1173 style C 6.3.  
 Application: Compact, handy style for working in confined spaces.  
 For applications where the bit must be held tight.

Order-No.	Ø	↔	↔	↕	↔
25874	1/4	35	146	30	10



### 281-02 Bit holder with handle, magnetic, 1/4".

Handle: Wiha SoftFinish® multi-component handle with roll-off protection.  
 Bit holder: Stainless steel with strong magnet.  
 Suitable for: For bits according to DIN 3126, ISO 1173 style C 6.3 and E 6.3.  
 Application: Compact screwdriver together with bits, 1/4".  
 Together with Wiha countersink bits, can be used as manual deburrer.

Order-No.	Ø	↔	↕	↔
32160	1/4	125	36	10

## Bit holder 1/4".



### 281 01 Bit holder with handle, magnetic, 1/4".

Handle: Ergonomic Wiha Stubby SoftFinish® handle, multi-component with roll-off protection.  
 Bit holder: Stainless steel with strong magnet.  
 Suitable for: For bits according to DIN 3126, ISO 1173 style C 6.3.  
 Application: For working in confined spaces.  
 Extra: Together with Wiha countersink bits, can be used as manual deburrer.

Order-No.	Ø	↔	↕	↔
29463	1/4	57	34	10



### 281-01ESD ESD bit holder with handle, retaining ring, 1/4". Dissipative handle, ESD-safe.

Handle: Ergonomic Wiha SoftFinish® multi-component handle with roll-off protection.  
 Surface resistance  $10^6 - 10^9$  ohms.  
 Universal use for all bits.  
 Standards: Handle: IEC 61340-5-1.  
 Output: For bits according to DIN 3126, ISO1173 style C 6.3.  
 Bit holder: Stainless steel with retaining ring.  
 Application: For working on electrostatically sensitive components, especially in tight places.

Order-No.	Ø	↔	↕	↔
32484	1/4	57	34	10



### 387ESD ESD bit holder with handle, quick release holder, 1/4". Dissipative handle, ESD-safe.

Handle: Ergonomic Wiha SoftFinish® multi-component handle with roll-off protection.  
 Surface resistance  $10^6 - 10^9$  ohms.  
 Standards: Handle: IEC 61340-5-1.  
 Output: For bits according to DIN 3126, ISO1173 style C 6.3, E 6.3 and double bits.  
 Input: DIN 3126, ISO 1173, style E 6.3.  
 Bit holder: Stainless steel with retaining ring.  
 Application: For working on electrostatically sensitive components.  
 With integrated CentroFix bit holder, suitable for all bits and bit drills with the style C 6.3, E 6.3 or double bits.  
 Extra: True single-handed operation, extremely high retention force of bits (up to 20 kg) and virtually no play between bit and holder thanks to special closing and holding mechanism.

Order-No.	Ø	↔	↔	↕	↔
32161	1/4	38	148	30	10

## Bit holder 1/4".

**388** Bit holder with handle, magnetic, 1/4".

Blade: Chrome-vanadium steel, through hardened, nickel-plated.  
 Handle: Wiha Classic T-handle.  
 Bit holder: Stainless steel with strong magnet.  
 Suitable for: For bits according to DIN 3126, ISO 1173 style C 6.3.  
 Application: For high torques.

Order-No.				
01481	1/4	150	80	10

## Offset screwdriver.

**SB24628** High-performance offset screwdriver with a 105° angled head. Blister packed.

Suitable for: For bits according to DIN 3126, ISO 1173 style C 6.3 and E 6.3.  
 Material: Steel housing, chrome-plated.  
 Application: For use in almost any (battery-powered) screwdriver; ideal for drilling and fastening/unfastening in hard-to-reach places, corners and edges.  
 Extra: A hand-operated locking sleeve ensures an optimal hold of all 1/4" inserts such as bits, drill bits and countersink bits. Stabilisation arm, adjustable in 48 positions; torque transmission up to 57 Nm. Compact, slim design.

Order-No.				
32310	1/4	1/4	165	1

57 Nm

**388DS** Bit holder with handle, magnetic, 1/4".

Blade: Chrome-vanadium steel, through hardened, nickel-plated.  
 Handle: Wiha ComfortGrip multi-component T-handle.  
 Bit holder: Stainless steel with strong magnet.  
 Suitable for: For bits according to DIN 3126, ISO 1173 style C 6.3.  
 Application: For high torques.  
 Extra: Two bit holders for 1/4" bits make this a universal tool. Bit holder on the side for particularly high torque.

Order-No.				
26179	1/4	150	100	10

**SB24629** Offset screwdriver with a 105° angled head, magnetic. Blister packed.

Suitable for: For bits according to DIN 3126, ISO 1173 style C 6.3 and E 6.3.  
 Material: Die cast housing, chrome-plated.  
 Application: For use in battery-powered and hand-held screwdrivers; ideal for drilling and fastening in hard-to-reach places, corners and edges.  
 Extra: Stabilisation arm, adjustable in 12 positions; torque transmission up to 14 Nm. Compact, slim design.

Order-No.				
32311	1/4	1/4	130	1

14 Nm

# Wiha magazine bit holder.

Everything in the palm of your hand.



reddot design award  
best of the best 2008



product design award  
2010 gold



product design award

Wiha magazine bit holders are ideally suited for those who require a variety of different screwdrivers but want to save space or weight.

Ergonomically designed handles of soft, skin-friendly material guarantee comfortable handling. High-quality bits can be cleverly stored in the handle.

The solution for bit storage and bit removal in the Wiha magazine bit holder 3809 received the coveted "red dot design award: best of the best."

The "telescopic" version of the magazine bit holder can be adapted to the space constraints using the length-adjustable bit adapter.

Small format – major professional quality: The short design of the Wiha Stubby 3801 magazine bit holder enables comfortable working in tight spaces.



## Wiha magazine bit holder.

- Unique fold-out mechanism
- Ergonomically designed SoftFinish multi-component handle
- 1/4" bit holder, magnetic



*The bit magazine accommodated by the handle is swung open with a light press of the thumb. The bits can then be quickly and simply changed.*



2012

## Wiha magazine bit holder telescopic

- Adjustable blade length from 50 - 85 mm. ClickStop ball clamp for secure hold and quick length adjustment
- ClicFix quick release holder, magnetic
- Adapter blade also suitable for use in battery-powered screwdrivers

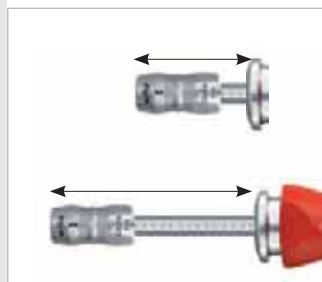

## Wiha magazine bit holder Stubby

- Extremely compact and light
- Ergonomically designed SoftFinish® Stubby multi-component handle
- 1/4" Stubby bit holder, magnetic



*Handy, compact and particularly suitable for working in confined spaces.*



product design award

2014



#### Magazine bit holder LiftUp 25

- Many versatile applications thanks to its 12 bits
- Bit magazine opens at the press of a button
- Ergonomically designed SoftFinish multi-component handle
- 1/4" bit holder, magnetic
- Turnable cap



Bit magazine opens at the press of a button.



product design award

2014



#### Magazine bit holder LiftUp 70

- With six 70 mm bits style E6.3
- Also ideal for use with a battery-powered screwdriver
- Particularly simple bit removal
- Bit magazine opens at the press of a button
- Ergonomically designed SoftFinish multi-component handle



#### Magazine bit holder Topra 2K bit

- Ergonomically designed pistol handle
- Finely serrated ratchet with 72 teeth, switchable
- Six 25mm bits in the handle
- 1/4" bit holder, magnetic, removable
- Further adaptors for SYSTEM6, 1/4" and 3/8" sockets available



Finely toothed, switchable ratchet

The **LiftUp 25** magazine bit holder saves space by storing 25mm bits in its handle. At the press of a button, the bit magazine at the handle end comes out and makes the bits available for removal.

But that's not all, the **LiftUp 70** version has space for six professional 70mm bits. Low-lying fastening elements can be reached more easily. "Long" bits also fully play off their advantages even in battery-powered screwdriver use.

Making a particularly powerful entrance – the new **Topra 2K** with six 25mm bits cleverly located in the ergonomic pistol handle. In addition, there is a finely serrated, switchable ratchet with bit holder.

# Wiha magazine bit holder.

Everything in the palm of your hand.

## Magazine bit holder 1/4", magnetic.



### 3809 01-01 Magazine bit holder, magnetic, 1/4".

Blade: High grade chrome-vanadium steel, through hardened.  
 Handle: Ergonomic Wiha SoftFinish® multi-component handle with roll-off protection.  
 Bit holder: Stainless steel with strong magnet.  
 Suitable for: DIN 3126, ISO 1173, style D 6.3.  
 Bits: 25 mm Standard bits.  
 Application: The alternative to a screwdriver set.  
 Eight drive shapes in one screwdriver.

Order-No.	Series				
32901	3809 01-01	5			
⓪	7010 Z	1x6.5			
⊕	7011 Z	1xPH1	1xPH2	1xPH3	
⊕	7012 Z	1xPZ2			
⊗	7015 Z	1xT15	1xT20	1xT25	

### SB 3809 01-01 Magazine bit holder, magnetic, 1/4". Blister packed.

Order-No.	Series				
33007	SB 3809 01-01	5			



### 3809 VH01 Magazine bit holder display. Card display with 8 pieces.

Order-No.	Content				
36167		1			
⓪ ⊕ ⊗	2 x 38090101	Magazin-Bithalter			
⓪ ⊕	6 x 380101	Magazin-Bithalter Stubby			

## Magazine bit holder 1/4", magnetic.



### 3809 01-02 Magazine bit holder, magnetic, 1/4".

Order-No.	Series				
32902	3809 01-02	5			
⊗	7015 Z	1xT6	1xT8	1xT10	1xT15
		1xT20	1xT25	1xT30	1xT40

### SB 3809 01-02 Magazine bit holder, magnetic, 1/4". Blister packed.

Order-No.	Series				
33008	SB 3809 01-02	5			



### 3809 01-03 Magazine bit holder, magnetic, 1/4".

Order-No.	Series				
32903	3809 01-03	5			
⓪	7010 Z	1x5.5	1x6.5		
⊕	7011 Z	1xPH1	3xPH2	2xPH3	

### SB 3809 01-03 Magazine bit holder, magnetic, 1/4". Blister packed.

Order-No.	Series				
33009	SB 3809 01-03	5			



### 3809 01-04 Magazine bit holder, magnetic, 1/4".

Order-No.	Series				
32904	3809 01-04	5			
⓪	7010 Z	1x5.5	1x6.5		
⊕	7012 Z	1xPZ1	3xPZ2	2xPZ3	

### SB 3809 01-04 Magazine bit holder, magnetic, 1/4". Blister packed.

Order-No.	Series				
33010	SB 3809 01-04	5			



### ClicFix magazine bit holder, telescopic.



#### 3809 284-01 Magazine bit holder ClicFix, magnetic, 1/4", telescopic.

**Blade:** High-quality chrome-molybdenum steel, through-hardened, chrome-plated.  
Adjustable blade length from 50 – 85 mm

**Handle:** Ergonomic Wiha SoftFinish® multi-component handle with roll-off protection.  
with integrated, swivelling bit magazine.  
With 6 mm hexagonal chuck for System 6-blades.  
ClickStop ball clamp for a secure hold and quick length adjustment.

**Bit holder:** ClicFix quick release holder, magnetic.  
Single-handed operation for fast bit changing.

**Suitable for:** DIN 3126, ISO 1173, style D 6.3.

**Bits:** 25 mm universal bits

**Application:** Eight drive shapes in one screwdriver.  
When a normal screwdriver is too long.  
Adapter blade also suitable for use in power screwdrivers

Order-No.	Series			
36394	3809 284-01			5
	① 7010 Z	1x5.5		
	⊕ 7011 Z	1xPH1	1xPH2	
	⊕ 7012 Z	1xPZ1	1xPZ2	
	⊕ 7015 Z	1xT15	1xT20	1xT25
	○ 284949	1xSYSTEM 6 ClicFix adapter blade, short		

#### SB 3809 284-01 Magazine bit holder ClicFix, magnetic, 1/4", telescopic. Blister packed.

Order-No.	Series	
36932	SB 3809 284-01	5

### ClicFix magazine bit holder, telescopic.



#### 3809 284-03 Magazine bit holder ClicFix, magnetic, 1/4", telescopic.

**Blade:** High-quality chrome-molybdenum steel, through-hardened, chrome-plated.  
Adjustable blade length from 50 – 85 mm

**Handle:** Ergonomic Wiha SoftFinish® multi-component handle with roll-off protection.  
with integrated, swivelling bit magazine.  
With 6 mm hexagonal chuck for System 6-blades.  
ClickStop ball clamp for a secure hold and quick length adjustment.

**Bit holder:** ClicFix quick release holder, magnetic.  
Single-handed operation for fast bit changing.

**Suitable for:** DIN 3126, ISO 1173, style D 6.3.

**Bits:** 25 mm universal bits

**Application:** Eight drive shapes in one screwdriver.  
When a normal screwdriver is too long.  
Adapter blade also suitable for use in power screwdrivers

Order-No.	Series				
36395	3809 284-03				5
	① 7010 Z	1x4.5	1x6.5		
	⊕ 7011 Z	1xPH1	1xPH2	1xPH3	
	⊕ 7012 Z	1xPZ1	1xPZ2	1xPZ3	
	○ 284949	1xSYSTEM 6 ClicFix adapter blade, short			

#### SB 3809 284-03 Magazine bit holder ClicFix, magnetic, 1/4", telescopic. Blister packed.

Order-No.	Series	
36933	SB 3809 284-03	5



#### 284949 SYSTEM 6 ClicFix adapter blade, short. Suitable for blades.

**Blade:** Chrome-vanadium steel, through hardened, chrome-plated.

**Design:** ClicFix mechanism.

Order-No.	○	←	→	5
36393	1/4	102		5

# Wiha magazine bit holder Stubby.

Six drive shapes in one screwdriver.

## Magazine bit holder 1/4", magnetic.



### 3801 01 Magazine bit holder Stubby, magnetic, 1/4".

Handle: Ergonomic Wiha SoftFinish® multi-component handle with roll-off protection.

Bit holder: Stainless steel with strong magnet.

Suitable for: DIN 3126, ISO 1173, style D 6.3.

Bits: 25 mm Standard bits.

Application: The alternative to a screwdriver set.

Six drive shapes in one screwdriver.

For working in confined spaces.

Order-No.	Series				
33736	3801 01				10
	⓪ 7010 Z	1x4.5	1x6.5	1x8.0	
	⊕ 7011 Z	1xPH1	1xPH2	1xPH3	

### SB 3801 01 Magazine bit holder Stubby, magnetic, 1/4". Blister packed.

Order-No.	Series	
33738	SB 3801 01	10



### 380... VH Stubby magazine bit holder displays. Carton displays with 10 pieces.

Order-No.	Art.-Nr.	Content	Quantity		
33739	308101 VH	380101	10	Slotted/ Phillips	1
33742	308102 VH	380102	10	Phillips/Pozidriv	1
33745	308103 VH	380103	10	TORX®	1
33747	308104 VH	380104	10	Slotted/ Pozidriv	1

## Magazine bit holder 1/4", magnetic.



### 3801 02 Magazine bit holder Stubby, magnetic, 1/4".

Order-No.	Series				
33740	3801 02				10
	⊕ 7011 Z	1xPH1	1xPH2	1xPH3	
	⊕ 7012 Z	1xPZ1	1xPZ2	1xPZ3	

### SB 3801 02 Magazine bit holder Stubby, magnetic, 1/4". Blister packed.

Order-No.	Series	
33741	SB 3801 02	10



### 3801 03 Magazine bit holder Stubby, magnetic, 1/4".

Order-No.	Series					
33743	3801 03					10
	⊕ 7015 Z	1xT10	1xT15	1xT20	1xT25	
		1xT30	1xT40			

### SB 3801 03 Magazine bit holder Stubby, magnetic, 1/4". Blister packed.

Order-No.	Series	
33744	SB 3801 03	10



### 3801 04 Magazine bit holder Stubby, magnetic, 1/4".

Order-No.	Series				
33764	3801 04				10
	⓪ 7010 Z	1x4.5	1x6.5	1x8.0	
	⊕ 7012 Z	1xPZ1	1xPZ2	1xPZ3	

### SB 3801 04 Magazine bit holder Stubby, magnetic, 1/4". Blister packed.

Order-No.	Series	
33746	SB 3801 04	10

# Wiha magazine bit holder LiftUp 25.

Everything in the palm of your hand.

## Magazine bit holder LiftUp 25, magnetic 1/4".



**NEW**

### 3803 02-020 Magazine bit holder LiftUp 25, magnetic 1/4".

Blade: High grade chrome-vanadium steel, through hardened.  
Handle: Ergonomic Wiha SoftFinish® multi-component handle with roll-off protection.

Bit holder: Of stainless steel, with powerful Neodym magnet.

Suitable for: DIN 3126, ISO 1173, style D 6.3.

Bits: 25 mm Standard bits.

Application: The alternative to a screwdriver set.

Compact storage for 12 bits in the handle.

Extra: For hand and machine operation.

Order-No.	Series					
38600	3803 02-020					5
	① 7010 Z	1x4.5	1x6.5			
	⊕ 7011 Z	1xPH1	1xPH2	1xPH3		
	⊗ 7012 Z	1xPZ1	1xPZ2	1xPZ3		
	⊛ 7015 Z	1xT15	1xT20	1xT25	1xT30	

**NEW**

### SB 3803 02-020 Magazine bit holder LiftUp 25, magnetic 1/4". Blister packed for hanging.

Order-No.	Series	
38605	SB 3803 02-020	5



**NEW**

### 3803 02-021 Magazine bit holder LiftUp 25, magnetic 1/4".

Order-No.	Series					
38601	3803 02-021					5
	① 7010 Z	1x5.5				
	⊕ 7011 Z	1xPH2				
	⊗ 7012 Z	1xPZ1	1xPZ2	1xPZ3		
	⊛ 7015 Z	1xT15	1xT20	1xT25	1xT30	
	⊙ 7013 Z	1x3.0	1x4.0	1x5.0		

**NEW**

### SB 3803 02-021 Magazine bit holder LiftUp 25, magnetic 1/4". Blister packed for hanging.

Order-No.	Series	
38606	SB 3803 02-021	5

## Magazine bit holder LiftUp 25, magnetic 1/4".



### 3803 02-022 Magazine bit holder LiftUp 25, magnetic 1/4".

**NEW**

Order-No.	Series					
38602	3803 02-022					5
	⊕ 7012 Z	1xPZ1	2xPZ2	1xPZ3		
	⊗ 7015 Z	1xT10	1xT15	2xT20	2xT25	
		1xT30	1xT40			

**NEW**

### SB 3803 02-022 Magazine bit holder LiftUp 25, magnetic 1/4". Blister packed for hanging.

Order-No.	Series	
38607	SB 3803 02-022	5



**NEW**

### 3803 02-023 Magazine bit holder LiftUp 25, magnetic 1/4".

Order-No.	Series					
38603	3803 02-023					5
	⊕ 7011 Z	1xPH1	1xPH2	1xPH3		
	⊗ 7012 Z	1xPZ1	1xPZ2	1xPZ3		
	⊛ 7015 Z	1xT10	1xT15	1xT20	2xT25	
		1xT30	1xT40			

**NEW**

### SB 3803 02-023 Magazine bit holder LiftUp 25, magnetic 1/4". Blister packed for hanging.

Order-No.	Series	
38608	SB 3803 02-023	5



### 3803 02-024 Magazine bit holder LiftUp 25, magnetic 1/4".

**NEW**

Order-No.	Series					
38604	3803 02-024					5
	⊕ 7011 Z	2xPH2				
	⊗ 7012 Z	1xPZ1	5xPZ2	1xPZ3		
	⊛ 7015 Z	1xT15	1xT20	1xT25		

**NEW**

### SB 3803 02-024 Magazine bit holder LiftUp 25, magnetic 1/4". Blister packed for hanging.

Order-No.	Series	
38609	SB 3803 02-024	5

# Wiha magazine bit holder LiftUp 70.

Everything in the palm of your hand.

## Magazine bit holder LiftUp 70, magnetic 1/4".



**NEW**

### 3803 01-020 Magazine bit holder LiftUp 70, magnetic 1/4".

Blade: High grade chrome-vanadium steel, through hardened.  
 Handle: Ergonomic Wiha SoftFinish® multi-component handle with roll-off protection.  
 Bit holder: Stainless steel, with powerful Neodym magnet.  
 Suitable for: DIN 3126, ISO 1173, style D 6.3.  
 Bits: 70 mm professional bits.  
 Application: The alternative to a screwdriver set.  
 Compact storage for 6 bits in the handle.  
 Extra: For hand and machine operation.

Order-No.	Series				
38588	3803 01-020				5
	Ⓢ 7040 Z	1x4.0	1x5.5	1x6.5	
	⊕ 7041 Z	1xPH1	1xPH2	1xPH3	

**NEW**

### SB 3803 01-020 Magazine bit holder LiftUp 70, magnetic 1/4". Blister packed for hanging.

Order-No.	Series	
38594	SB 3803 01-020	5



**NEW**

### 3803 01-024 Magazine bit holder LiftUp 70, magnetic 1/4".

Order-No.	Series					
38592	3803 01-024					5
	⊕ 7045 Z	1xT10	1xT15	1xT20	1xT25	
		1xT30	1xT40			

**NEW**

### SB 3803 01-024 Magazine bit holder LiftUp 70, magnetic 1/4". Blister packed for hanging.

Order-No.	Series	
38598	SB 3803 01-024	5



**NEW**

### 3803 01-025 Magazine bit holder LiftUp 70, magnetic 1/4".

Order-No.	Series				
38593	3803 01-025				5
	⊕ 7042 Z	1xPZ1	4xPZ2	1xPZ3	

**NEW**

### SB 3803 01-025 Magazine bit holder LiftUp 70, magnetic 1/4". Blister packed for hanging.

Order-No.	Series	
38599	SB 3803 01-025	5

## Magazine bit holder LiftUp 70, magnetic 1/4".



**NEW**

### 3803 01-021 Magazine bit holder LiftUp 70, magnetic 1/4".

Order-No.	Series			
38589	3803 01-021			5
	Ⓢ 7040 Z	1x5.5		
	⊕ 7041 Z	1xPH2		
	⊕ 7042 Z	1xPZ1	1xPZ2	
	⊕ 7045 Z	1xT20	1xT25	

**NEW**

### SB 3803 01-021 Magazine bit holder LiftUp 70, magnetic 1/4". Blister packed for hanging.

Order-No.	Series	
38595	SB 3803 01-021	5



**NEW**

### 3803 01-022 Magazine bit holder LiftUp 70, magnetic 1/4".

Order-No.	Series					
38590	3803 01-022					5
	⊕ 7042 Z	1xPZ1	1xPZ2			
	⊕ 7045 Z	1xT15	1xT20	1xT25	1xT30	

**NEW**

### SB 3803 01-022 Magazine bit holder LiftUp 70, magnetic 1/4". Blister packed for hanging.

Order-No.	Series	
38596	SB 3803 01-022	5



**NEW**

### 3803 01-023 Magazine bit holder LiftUp 70, magnetic 1/4".

Order-No.	Series				
38591	3803 01-023				5
	⊕ 7041 Z	1xPH2			
	⊕ 7042 Z	1xPZ1	1xPZ2	1xPZ3	
	⊕ 7045 Z	1xT20	1xT25		

**NEW**

### SB 3803 01-023 Magazine bit holder LiftUp 70, magnetic 1/4".

Order-No.	Series	
38597	SB 3803 01-023	5

# Wiha Topra 2K bit.

Everything in the palm of your hand.

## Magazine bit holder Topra 2K bit, magnetic 1/4".



**NEW**

### 28201-01 Topra 2K bit, assorted.

- Handle:** Ergonomically designed two-component pistol handle for powerful fastening.
- Design:** Finely serrated ratchet mechanism with 72 teeth and minimal switching angle of just 5°. Clockwise and anticlockwise rotation can be switched.
- Bit holder:** Exchangeable magnet bit holder 1/4". With strong Neodym magnet.
- Suitable for:** DIN 3126, ISO 1173 style D 6.3.
- Bits:** 25 mm Standard bits.
- Application:** Enables powerful fastening without fatigue. 6 bits in one compact tool.

Order-No.	Series				
38915	28201-01				5
	① 7010 Z	1x5.5	1xPH2		
	⊕ 7011 Z	1xPH1	1xPH2		
	⊕ 7012 Z	1xPZ1	1xPZ2		

**NEW**

### SB 28201-01 Topra 2K bit, assorted. Blister packed.

Order-No.	Series				
39136	SB 28201-01				5



**NEW**

### 28201-02 Topra 2K bit, TORX®.

Order-No.	Series				
38916	28201-02				5
	⊕ 7015 Z	1xT10	1xT15	1xT20	
		1xT25	1xT30	1xT40	

**NEW**

### SB 28201-02 Topra 2K bit, TORX®. Blister packed.

Order-No.	Series				
39137	SB 28201-02				5

## Magazine bit holder Topra 2K bit, magnetic 1/4". Adapter.



**NEW**

### 28201-03 Topra 2K bit, hex.

Order-No.	Series				
39135	28201-03				5
	● 7013 Z	1x2.0	1x2.5	1x3.0	
		1x4.0	1x5.0	1x6.0	

**NEW**

### SB 28201-03 Topra 2K bit, hex. Blister packed.

Order-No.	Series				
39138	SB 28201-03				5



**NEW**

### 28339-91 Torque TR / Topra 2K bit universal holder. Accommodates 1/4" bits.

**Blade:** High quality chrome-vanadium molybdenum steel.

Order-No.	○	↔	●	
39255	1/4	45	6	1



**NEW**

### 28339 Torque TR / Topra 2K adapter blade. Suitable for 1/4" resp. 3/8" square sockets.

**Blade:** High quality chrome-vanadium molybdenum steel.

Order-No.	●	↔	●	
39256	1/4	52	6	1
39257	3/8	52	6	1



**NEW**

### 28339-94 SYSTEM 6 adapter Topra 2K Insertion of SYSTEM 6 blades.

**Blade:** High quality chrome-vanadium molybdenum steel.

Order-No.	○	↔	●	
39383	6	58.5	6	1



# Wiha BitBuddy®.

Maximum efficiency by direct insert of bits.



No hand free?  
And which bit has the profile you need?

The Wiha BitBuddy® eliminates such day-to-day problems when changing bits, because the new bit box enables you to work more efficiently and quickly than ever before. With consistent single-hand operation and according to the simple principle: "Plug-Work-Store"

Push the Wiha logo a little, and the torsion bits are ready for inserting in the bit holder! The profile type is additionally lasered to the bit base and can thus be instantly identified. The innovative terminal block with push buttons accommodates the bits securely later.

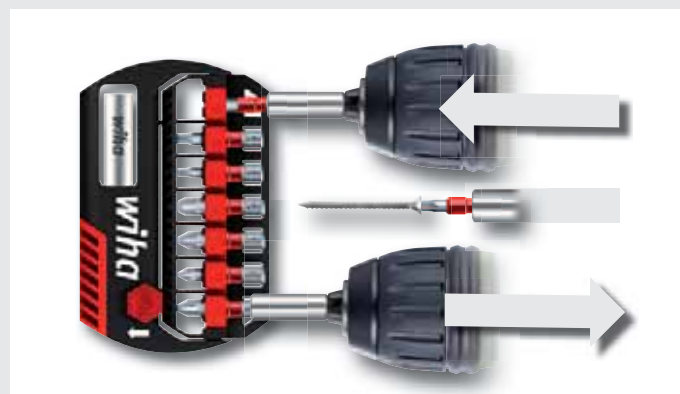

Tried-and-proven as ever: compact dimensions and the Wiha box design tried and tested a million times also characterise the new BitBuddy®. It's always ready to use on a ladder, on the ground or below the ceiling.

The BitBuddy® is available with the 29-series and 49-series assortment of new Maxx torsion bits.



Belt clip suitable for both boxes.  
Buddy always fits – in any position!  
- Open box  
- Closed box  
- Front  
- Rear



## Wiha BitBuddy®.

- Consistent single-handed operation: Opening at the press of a button, simple bit changing thanks to the innovative arrangement of the bits.
- Easy identification: Profile size lasered on the bit base
- At 99 x 63 x 17 mm, it fits into any shirt or trouser pocket or in the optional belt clip
- Robust, impact resistant polyamide

## BitBuddy® 29.



## NEW

## 7945-202 BitBuddy® 29, Pozidriv, 8 pcs.

Housing: Box of impact resistant, glass-fibre reinforced polyamide - permanently robust.

Bit clamping element with push buttons, 180° rotation.

Extra folding element for the magnetic bit holder.

Bits: 29er® MaxxTor bits.

Geometry: Maximum length torsion zone individually matched to the profile.  
Precision-milled profile for perfect fit and maximum performance.

Bit holder: Universal holder 1/4", magnetic - ideal for rapid bit changing.

Application: Compact bit box with the most common bits. Ideal for frequently varying fastening applications within one work sector.

Push the Wiha logo slightly, and the bits are ready to be inserted into the bit holder!

Plug & Work & Store - Maximum efficiency due to direct bit insertion without any problems. Insert, work, store.

Extra: Design tried and tested a million times

Always ready to use - easily fits into trouser pockets or the belt clip.

Order-No.	Series	
37318	7945-202	10
	7113 S	1xUniversal holder 58 mm, magnetic
	7012 M9T	1xPZ1 5xPZ2 1xPZ3

## NEW

## SB 7945-202 BitBuddy® 29, Pozidriv, 8 pcs.

With belt clip.

Blister packed for hanging.

Order-No.	Series	
38021	SB 7945-202	10



## 7945-303 BitBuddy® 29, hex, 8 pcs.

Order-No.	Series	
36919	7945-303	10
	7113 S	1xUniversal holder 58 mm, magnetic
	7013 M9T	2x3.0 2x4.0 2x5.0 1x6.0

## SB7945-303 BitBuddy® 29, hex, 8 pcs.

With belt clip.

Blister packed for hanging.

Order-No.	Series	
36934	SB7945-303	10

## BitBuddy® 29.



## 7945-505 BitBuddy® 29, TORX®, 8 pcs.

Order-No.	Series	
36920	7945-505	10
	7113 S	1xUniversal holder 58 mm, magnetic
	7015 M9T	1xT10 1xT15 2xT20 1xT25
		1xT30 1xT40

## SB 7945-505 BitBuddy® 29, TORX®, 8 pcs.

With belt clip.

Blister packed for hanging.

Order-No.	Series	
36935	SB 7945-505	10



## 7945-903 BitBuddy® 29, mixed, 8 pcs.

Order-No.	Series	
36921	7945-903	10
	7113 S	1xUniversal holder 58 mm, magnetic
	7011 M9T	1xPH2
	7012 M9T	1xPZ1 1xPZ2 1xPZ3
	7015 M9T	1xT15 1xT20 1xT25

## SB 7945-903 BitBuddy® 29, mixed, 8 pcs.

With belt clip.

Blister packed for hanging.

Order-No.	Series	
36936	SB 7945-903	10

# Wiha BitBuddy®.

Maximum efficiency by direct insert of bits.

## BitBuddy® 29.



**7945-904** BitBuddy® 29, mixed, 8 pcs.

Order-No.	Series					
36922	7945-904					10
	7113 S	1xUniversal holder 58 mm, magnetic				
	⊕ 7011 M9T	1xPH2				
	⊕ 7012 M9T	1xPZ1		1xPZ2		
	⊕ 7015 M9T	1xT10		1xT15 1xT20 1xT25		

**SB7945-904** BitBuddy® 29, mixed, 8 pcs.  
With belt clip.  
Blister packed for hanging.

Order-No.	Series	
36937	SB7945-904	10



**7945-905** BitBuddy® 29, mixed, 8 pcs.

Order-No.	Series					
36923	7945-905					10
	7113 S	1xUniversal holder 58 mm, magnetic				
	⊕ 7012 M9T	1xPZ2		1xPZ3		
	⊕ 7015 M9T	1xT15		1xT20 1xT25 1xT30		

**SB 7945-905** BitBuddy® 29, mixed, 8 pcs.  
With belt clip.  
Blister packed for hanging.

Order-No.	Series	
36938	SB 7945-905	10

## Carton displays BitBuddy 29



**NEW**  
**7945 VB1** Display BitBuddy 29, TORX®.  
Card display with 10 pieces.

Size: 37 x 17.5 x 34 cm (WxDxH).

Order-No.	Series	
37196	7945 VB1	1
	7945	Belt clip for BitBuddy® and FlipSelector. Suitable for Buddy 29 and Buddy 49 and FlipSelector.
	⊕ 7945-505	BitBuddy® 29, TORX®, 8 pcs. 7113 S: Universal holder 58 mm, magnetic 7015 M9T: 1xT10 1xT15 2xT20 1xT25 1xT40



**NEW**  
**7945 VB2** Display BitBuddy 29, assorted.  
Card display with 10 pieces.

Size: 37 x 17.5 x 34 cm (WxDxH).

Order-No.	Series	
37197	7945 VB2	1
	7945	Belt clip for BitBuddy® and FlipSelector. Suitable for Buddy 29 and Buddy 49 and FlipSelector.
	⊕ ⊕ ⊕ 7945-903	BitBuddy® 29, mixed, 8 pcs. 7113 S: Universal holder 58 mm, magnetic 7011 M9T: 1xPH2 7012 M9T: 1xPZ1 1xPZ2 1xPZ3 7015 M9T: 1xT15 1xT20 1xT25



**NEW**  
**7945 VB3** Display BitBuddy 29, Pozidriv.  
Card display with 10 pieces.

Order-No.	Series	
37325	7945 VB3	1
	7945	Belt clip for BitBuddy® and FlipSelector. Suitable for Buddy 29 and Buddy 49 and FlipSelector.
	⊕ 7945-202	BitBuddy® 29, Pozidriv, 8 pcs. 7113 S: Universal holder 58 mm, magnetic 7012 M9T: 1xPZ1 5xPZ2 1xPZ3

Acryl glass displays BitBuddy 29



**NEW**  
**7945 VBX1** Display BitBuddy 29, assorted.  
 Acryl glass display with 30 pieces.  
 Size: 34 x 26.5 x 35 cm (WxDxH).

Order-No.	Series	
37200	7945 VBX1	1
⊕ ⊕	7945-905	BitBuddy® 29, mixed, 8 pcs. 7113 S: Universal holder 58 mm, magnetic 7012 M9T: 1xPZ2 1xPZ3 7015 M9T: 1xT15 1xT20 1xT25 1xT30 1xT40
⊕	7945-505	BitBuddy® 29, mixed, 8 pcs. 7113 S: Universal holder 58 mm, magnetic 7015 M9T: 1xT15 1xT20 1xT25 1xT30 1xT40
⊕ ⊕ ⊕	7945-903	BitBuddy® 29, mixed, 8 pcs. 7113 S: Universal holder 58 mm, magnetic 7011 M9T: 1xPH2 7012 M9T: 1xPZ1 1xPZ2 1xPZ3 7015 M9T: 1xT15 1xT20 1xT25

Acryl glass displays BitBuddy 29 + Belt clip.



**NEW**  
**7945 VBX3** Display BitBuddy 29, assorted.  
 Acryl glass display with 42 pieces.  
 Size: 34 x 26.5 x 35 cm (WxDxH).

Order-No.	Series	
38035	7945 VBX3	1
⊕	7011 M9T	29er® MaxxTor bit, Phillips, style C 6.3. PH2x29
⊕	7012 M9T	29er® MaxxTor bit, Pozidriv, style C 6.3. PZ1x29 PZ2x29 PZ3x29
⊕	7015 M9T	29er® MaxxTor bit, TORX®, style C 6.3. T20x29 T25x29 T30x29 T40x29
⊕ ⊕ ⊕	7945-903	BitBuddy® 29, mixed, 8 pcs. 7113 S: Universal holder 58 mm, magnetic 7011 M9T: 1xPH2 7012 M9T: 1xPZ2 1xPZ2 1xPZ3 7015 M9T: 1xT15 1xT20 1xT25



**7945** Belt clip for BitBuddy® and FlipSelector.  
 Suitable for Buddy 29 and Buddy 49 and FlipSelector.  
 Material: High quality, impact resistant plastic.

Order-No.	
36990	10



# Wiha BitBuddy®.

Maximum efficiency by direct insert of bits.

## BitBuddy® 49.



**NEW**

**7946-202** BitBuddy® 49, Pozidriv, 7 pcs.

Housing: Box of impact resistant, glass-fibre reinforced polyamide - permanently robust.

Bit clamping element with push buttons.

Bits: 49er MaxxTor bits.

Geometry: Length torsion zone individually matched to the profile.

Precision-milled profile for perfect fit and maximum performance.

Application: Compact bit box with the most common bits. Ideal for frequently varying fastening applications within one work sector.

Innovative operating concept enables consistent single-handed operation.

Push the Wiha logo slightly, and the bits are ready to be inserted into the bit holder!

Plug & Work & Store - Maximum efficiency due to direct bit insertion without any problems. Insert, work, store.

Extra: Always ready to use - easily fits into trouser pockets or the belt clip.

Order-No.	Series				
37319	7946-202				10
	⊕ 7042 M9T	1xPZ1	5xPZ2	1xPZ3	

**NEW**

**SB 7946-202** BitBuddy® 49, Pozidriv, 7 pcs.

With belt clip.

Blister packed for hanging.

Order-No.	Series				
38029	SB 7946-202				10



**NEW**

**7946-303** BitBuddy® 49, hex, 7 pcs.

Order-No.	Series					
36924	7946-303					10
	⊙ 7043 M9T	2x3.0	2x4.0	2x5.0	1x6.0	

**NEW**

**SB 7946-303** BitBuddy® 49, hex, 7 pcs.

With belt clip.

Blister packed for hanging.

Order-No.	Series				
36939	SB 7946-303				10

## BitBuddy® 49.



**7946-505** BitBuddy® 49, TORX®, 7 pcs.

Order-No.	Series					
36925	7946-505					10
	⊛ 7045 M9T	1xT10	1xT15	2xT20	1xT25	
		1xT30	1xT40			

**SB 7946-505** BitBuddy® 49, TORX®, 7 pcs. With belt clip.

Blister packed for hanging.

Order-No.	Series				
36940	SB 7946-505				10



**7946-903** BitBuddy® 49, mixed, 7 pcs.

Order-No.	Series					
36926	7946-903					10
	⊕ 7041 M9T	1xPH2				
	⊕ 7042 M9T	1xPZ1	1xPZ2	1xPZ3		
	⊛ 7045 M9T	1xT15	1xT20	1xT25		

**SB 7946-903** BitBuddy® 49, mixed, 7 pcs. With belt clip.

Blister packed for hanging.

Order-No.	Series				
36941	SB 7946-903				10



**7946-904** BitBuddy® 49, mixed, 7 pcs.

Order-No.	Series					
36927	7946-904					10
	⊕ 7041 M9T	1xPH2				
	⊕ 7042 M9T	1xPZ1	1xPZ2			
	⊛ 7045 M9T	1xT10	1xT15	1xT20	1xT25	

**SB 7946-904** BitBuddy® 49, mixed, 7 pcs. With belt clip.

Blister packed for hanging.

Order-No.	Series				
36942	SB 7946-904				10



## BitBuddy® 49. Display BitBuddy 49.



**7946-905** BitBuddy® 49, mixed, 7 pcs.

Order-No.	Series					
36928	7946-905	10				
	⊕ 7042 M9T	1xPZ2	1xPZ3			
	⊕ 7045 M9T	1xT15	1xT20	1xT25	1xT30	
		1xT40				

**SB 7946-905** BitBuddy® 49, mixed, 7 pcs.  
With belt clip.  
Blister packed for hanging.

Order-No.	Series		
36943	SB 7946-905	10	

## Carton displays BitBuddy 49



**NEW**  
**7946 VB1** Display BitBuddy 49, TORX®.  
Card display with 10 pieces.

Size: 37 x 17.5 x 34 cm (WxDxH).

Order-No.	Series		
37198	7946 VB1	1	
	7945	Belt clip for BitBuddy® and FlipSelector. Suitable for Buddy 29 and Buddy 49 and FlipSelector.	
	⊕ 7946-505	BitBuddy® 49, TORX®, 7 pcs. 7045 M9T: 1xT10 1xT15 2xT20 1xT25 1xT30 1xT40	



**NEW**  
**7946 VBX1** Display BitBuddy 49, assorted.  
Acryl glass display with 30 pieces.

Size: 34 x 26.5 x 35 cm (WxDxH).

Order-No.	Series					
37201	7946 VBX1	1				
	⊕ ⊕ 7946-905	7042 M9T: 1xPZ2	1xPZ3			
		7045 M9T: 1xT15	1xT20	1xT25	1xT30	
		1xT40				
	⊕ 7946-505	BitBuddy® 49, TORX®, 7 pcs. 1xT10				
		7045 M9T: 1xT15	1xT20	1xT25	1xT30	
		1xT40				
	⊕ ⊕ ⊕ 7946-903	BitBuddy® 49, mixed, 7 pcs.				
		7041 M9T: 1xPH2	1xPZ1			
		7042 M9T: 1xPZ2	1xPZ3			
		7045 M9T: 1xT15	1xT20	1xT25		



**NEW**  
**7946 VB2** Display BitBuddy 49, assorted.  
Card display with 10 pieces.

Size: 37 x 17.5 x 34 cm (WxDxH).

Order-No.	Series		
37199	7946 VB2	1	
	7945	Belt clip for BitBuddy® and FlipSelector. Suitable for Buddy 29 and Buddy 49 and FlipSelector.	
	⊕ ⊕ 7946-903	BitBuddy® 49, mixed, 7 pcs. 7041 M9T: 1xPH2 7042 M9T: 1xPZ1 1xPZ2 1xPZ3 7045 M9T: 1xT15 1xT20 1xT25	



**NEW**  
**7946 VB3** Display BitBuddy 49, Pozidriv.  
Card display with 10 pieces.

Order-No.	Series		
37326	7946 VB3	1	
	7945	Belt clip for BitBuddy® and FlipSelector. Suitable for Buddy 29 and Buddy 49 and FlipSelector.	
	⊕ 7946-202	BitBuddy® 49, Pozidriv, 7 pcs. 7042 M9T: 1xPZ1 5xPZ2 1xPZ3	

# Wiha FlipSelector and XLSelector.

Couldn't be smaller!



The Wiha FlipSelector: simplest handling guaranteed.

As the successor of the XSelector, the FlipSelector also features compactness, but combines it with even easier handling and 2 additional bit slots.

Now with 12 bits, the configuration variants can be ideally adapted to individual types of applications.

Simply slide the Wiha logo down and the bit clamping element pivots by 180° and releases the bits for removal.

The XLSelector is perfect for those who need more than 12 bits. It holds 30 bits and thus covers an extremely broad fastening spectrum. Thanks to its super-flat design, it fits easily into any electrical toolbox.



Always ready to hand, without annoying searching.



Because it is extremely flat and compact, the XLSelector fits into any case



## Wiha FlipSelector

- Contains 12 bits and a bit holder
- Bit box made of impact-resistant polyamide – permanently robust
- Effortless handling, opens at the press of a button
- At 99 x 63 x 17 mm, it fits into any shirt or trouser pocket
- Optional belt clip available to facilitate work further



## Wiha XLSelector

- Extremely flat and compact bit box containing 30 bits and a bit holder
- Simple removal of the clearly arranged bits
- At 135x80x17.5 mm, there is space for the XLSelector even in fully packed electrical toolboxes

# Wiha XLSelector.

Couldn't be smaller!

## Standard and security bits.



### 7948-005 XLSelector Standard, mixed, 31 pcs.

Housing: Box made of high quality plastic.  
The simplest bit removal guaranteed.

Bits: 25 mm Standard bits.

Bit holder: Universal holder, magnetic.

Application: All types of fastenings for trade and industry – it can't get any more compact!

Extra: Soft zones for maximum working comfort.

Order-No.	Series					
29417	7948-005					5
⓪	7010 Z	1x4.5	1x5.5	1x6.5		
⊕	7011 Z	2xPH1	4xPH2	1xPH3		
⊕	7012 Z	2xPZ1	5xPZ2	1xPZ3		
⊕	7015 Z	2xT10	2xT15	2xT20	3xT25	
		2xT30	1xT40			
	7113 S	1xUniversal holder 58 mm, magnetic				



### 7948-927 XLSelector Standard, Security, 31 pcs.

Housing: Box made of high quality plastic.  
The simplest bit removal guaranteed.

Bits: 25 mm ZOT Torsion and Standard bits.

Bit holder: ClicFix quick release holder, magnetic.

Application: All types of fastenings for trade and industry – it can't get any more compact!

Extra: Soft zones for maximum working comfort.  
Bits for popular security screws.

Order-No.	Series					
29416	7948-927					5
⓪	7019 ZOT TW	1x0	1x1	1x2	1x3	
		1x4				
⓪	7019 Z SP	1x4	1x6	1x8	1x10	
⓪	7013 Z TR	1xTR2.0	1xTR2.5	1xTR3.0	1xTR4.0	
		1xTR5.0	1xTR6.0			
⊕	7019 ZOT TS	1x6	1x8	1x10		
⊕	7015 Z TR	1xT8H	1xT9H	1xT10H	1xT15H	
		1xT20H	1xT25H	1xT27H	1xT30H	
		1xT40H				
⓪	7018 Z	1xRobertson 1	1xRobertson 2	1xRobertson 3		
	7148CM	1xCentroFix quick release holder, magnetic				

## ZOT Torsion and Professional bits.



### 7948-047 XLSelector Torsion, mixed, 31 pcs.

Housing: Box made of high quality plastic.  
The simplest bit removal guaranteed.

Bits: 25 mm ZOT Torsion and Standard bits.

Geometry: Patented torsion zone to prevent premature breaking of the bit when under stress.

Bit holder: ClicFix quick release holder, magnetic.

Application: Especially suitable for fastenings in metal and hard materials – it can't get any more compact!

Extra: Soft zones for maximum working comfort.

Order-No.	Series				
29415	7948-047				5
⓪	7010 ZOT	1x5.5	1x6.5	1x8.0	
⊕	7011 ZOT	2xPH1	5xPH2	2xPH3	
⊕	7012 ZOT	2xPZ1	5xPZ2	2xPZ3	
⓪	7013 Z	1x4.0	1x5.0	1x6.0	
⊕	7015 ZOT	1xT10	1xT15	1xT20	1xT25
		1xT30	1xT40		
	7148CM	1xCentroFix quick release holder, magnetic			



### 7948-928 XLSelector Torsion Professional, mixed, 13 pcs.

Housing: Box made of high quality plastic.  
The simplest bit removal guaranteed.

Bits: 52 mm ZOT Torsion and Professional bits.

Bit holder: CentroFix quick release holder, magnetic, style E 6.3.

Application: Especially suitable for fastenings in metal and hard materials – it can't get any more compact!

Extra: Soft zones for maximum working comfort.

Order-No.	Series				
33663	7948-928				5
⊕	7041 ZOT	1xPH1	1xPH2	1xPH3	
⊕	7042 ZOT	1xPZ1	1xPZ2	1xPZ3	
⊕	7045 Z	1xT10	1xT15	1xT20	1xT25
		1xT30	1xT40		
	7148C	1xCentroFix quick release holder, style E 6.3			

# Wiha XLSelector.

Couldn't be smaller!

## XLSelector sales counter display.



**7948 VB1** XLSelector display.  
Acryl glass display with 6 pieces.  
Size: 25 x 12 x 34 cm (WxDxH)

Order-No.	Series					
29541	7948 VB1					1
	① 7010 Z	1x4.5	1x5.5	1x6.5		
	⊕ 7011 Z	2xPH1	4xPH2	1xPH3		
	⊕ 7012 Z	2xPZ1	5xPZ2	1xPZ3		
	⊕ 7015 Z	2xT10	2xT15	2xT20	3xT25	
		2xT30	1xT40			
	7113 S	1xUniversal holder 58 mm magnetic				



**7948 VB2** XLSelector display.  
Acryl glass display with 6 pieces.

Order-No.	Series					
36165	7948 VB2					1
	⊕ 7012 HOT	3xPZ1	10xPZ2	2xPZ3		
	⊕ 7015 Z	2xT10	2xT15	3xT20	4xT25	
		2xT30	2xT40			
	7113 S	1xUniversal holder 58 mm magnetic				



**7948 VB3** XLSelector display.  
Acryl glass display with 6 pieces.

Order-No.	Series					
36166	7948 VB3					1
	⊕ 7041 ZOT	1xPH1	1xPH2	1xPH3		
	⊕ 7042 ZOT	1xPZ1	1xPZ2	1xPZ3		
	⊕ 7045 Z	1xT10	1xT15	1xT20	1xT25	
		1xT30	1xT40			
	7148C	1xCentroFix quick release holder style E 6.3				

## XLSelector with bit ratchet.



**7948-043** XLSelector Torsion, mixed, with 1/4" bit ratchet, 17-pcs.

Housing: Box made of high quality plastic.  
Contains 15 bits, bitholder and bit ratchet.  
Bits: 25 mm Z and ZOT bits.  
Geometry: Patented torsion zone to prevent premature breaking of the bit when under stress.  
Bit holder: 1/4" universal holder, magnetic.  
Application: Universal assortment for all types of fastening in trade and industry.  
More applications with practical bit ratchet.  
Extra: 1/4" universal holder can be used as an extension.

Order-No.	Series					
36951	7948-043					5
	⊕ 7011 ZOT	1xPH1	1xPH2			
	⊕ 7012 ZOT	1xPZ1	1xPZ2	1xPZ3		
	⊕ 7013 Z	1x3.0	1x4.0	1x5.0	1x6.0	
	⊕ 7015 ZOT	1xT10	1xT15	1xT20	1xT25	
		1xT30	1xT40			
	7113 S	1xUniversal holder 58 mm, magnetic				
	SB 2463 001	1x1/4" bit ratchet, with thumb wheel				



**7948 VB4** XLSelector with bit ratchet, display, 6-pcs.  
Acryl glass display with 6 pieces.

Order-No.	Series					
36929	7948 VB4					1
	⊕ 7011 ZOT	1xPH1	1xPH2			
	⊕ 7012 ZOT	1xPZ1	1xPZ2	1xPZ3		
	⊕ 7013 Z	1x3.0	1x4.0	1x5.0	1x6.0	
	⊕ 7015 ZOT	1xT10	1xT15	1xT20	1xT25	
		1xT30	1xT40			
	7113 S	1xUniversal holder 58 mm magnetic				
	SB 2463 001	1x1/4" bit ratchet with thumb wheel				



# Wiha FlipSelector.

Couldn't be smaller!

## DuraBits with torsion zone.



**NEW**

### 7947-0DR7 FlipSelector Torsion Dura, assorted, 13-pcs.

**Housing:** Box of impact resistant, glass-fibre reinforced polyamide - permanently robust.

Bit clamping element can be swivelled 180°. Extra folding element for the magnetic bit holder.

**Bits:** 25 mm DuraBits with torsion zone.

Extremely wear-resistant Dura tip with hard-metal coating grips into the screw head and prevents the bit from slipping.

**Geometry:** Patented torsion zone to prevent premature breaking of the bit when under stress.

**Bit holder:** CentroFix quick release holder, magnetic, style E 6.3.

**Application:** Compact bit box with 12 high quality bits. Slide the Wiha logo down – and the bits are immediately available for removal.

**Extra:** Design tried and tested a million times

Bits for safe work without fatigue. Always ready to use - easily fits into trouser pockets or the belt clip.

Order-No.	Series				
39034	7947-0DR7				10
	① 7010 DR	1x5.5			
	⊕ 7011 DR	1xPH1	3xPH2	1xPH3	
	⊗ 7012 DR	1xPZ1	4xPZ2	1xPZ3	
	7148CM	1xCentroFix quick release holder, magnetic			

**NEW**

### SB 7947-0DR7 FlipSelector Torsion Dura, assorted, 13-pcs.

With belt clip. Blister packed.

Order-No.	Series	
39053	SB 7947-0DR7	10



**NEW**

### 7947-9DR7 FlipSelector Torsion Dura, assorted, 13-pcs.

Order-No.	Series					
39046	7947-9DR7					10
	⊕ 7012 DR	1xPZ1	2xPZ2	1xPZ3		
	⊗ 7015 DR	1xT10	1xT15	2xT20	2xT25	
		1xT30	1xT40			
	7148CM	1xCentroFix quick release holder, magnetic				

**NEW**

### SB 7947-9DR7 FlipSelector Torsion Dura, assorted, 13-pcs.

With belt clip. Blister packed.

Order-No.	Series	
39065	SB 7947-9DR7	10

## Diamond torsion bits.



**NEW**

### 7947-0D7 FlipSelector Torsion Diamant, assorted, 13-pcs.

**Housing:** Box of impact resistant, glass-fibre reinforced polyamide - permanently robust.

Bit clamping element can be swivelled 180°.

Extra folding element for the magnetic bit holder.

**Bits:** 25 mm Diamond Torsion bits.

**Geometry:** Patented torsion zone to prevent premature breaking of the bit when under stress.

**Bit holder:** CentroFix quick release holder, magnetic, style E 6.3.

**Application:** Compact bit box with 12 high quality bits. Slide the Wiha logo down – and the bits are immediately available for removal.

Bits for fatigue-free work; bits ideal for frequent fastening.

**Extra:** Design tried and tested a million times

Always ready to use - easily fits into trouser pockets or the belt clip.

Order-No.	Series				
39079	7947-0D7				10
	① 7010 D	1x5.5			
	⊕ 7011 D	1xPH1	3xPH2	1xPH3	
	⊗ 7012 D	1xPZ1	4xPZ2	1xPZ3	
	7148CM	1xCentroFix quick release holder, magnetic			

**NEW**

### SB 7947-0D7 FlipSelector Torsion Diamant, assorted, 13-pcs.

With belt clip. Blister packed.

Order-No.	Series	
39084	SB 7947-0D7	10



**NEW**

### 7947-9D7 FlipSelector Torsion Diamant, assorted, 13-pcs.

Order-No.	Series					
39080	7947-9D7					10
	⊕ 7012 D	1xPZ1	2xPZ2	1xPZ3		
	⊗ 7015 D	1xT10	1xT15	2xT20	2xT25	
		1xT30	1xT40			
	7148CM	1xCentroFix quick release holder, magnetic				

**NEW**

### SB 7947-9D7 FlipSelector Torsion Diamant, assorted, 13-pcs.

With belt clip. Blister packed.

Order-No.	Series	
39085	SB 7947-9D7	10



# Wiha FlipSelector.

Couldn't be smaller!

## TiN Torsion bits.



**NEW**

**7947-065** FlipSelector Torsion TiN, assorted, 13-pcs.

Housing: Box of impact resistant, glass-fibre reinforced polyamide - permanently robust.

Bit clamping element can be swivelled 180°. Extra folding element for the magnetic bit holder.

Bits: 25 mm TiN Torsion bits.

Geometry: Patented torsion zone to prevent premature breaking of the bit when under stress.

Coating: TiN coating, extends the tool life.

Bit holder: 1/4" universal holder, magnetic.

Application: Compact bit box with 12 high quality bits. Slide the Wiha logo down – and the bits are immediately available for removal.

Bits for craftsmen and industry, especially for series connections.

Extra: Design tried and tested a million times

Always ready to use - easily fits into trouser pockets or the belt clip.

Order-No.	Series				
39032	7947-065				10
	7113 S	1xUniversal holder 58 mm, magnetic			
	⓪ 7010 TiN	1x5.5			
	⊕ 7011 TiN	1xPH1	3xPH2	1xPH3	
	⊗ 7012 TiN	1xPZ1	4xPZ2	1xPZ3	

**NEW**

**SB 7947-065** FlipSelector Torsion TiN, assorted, 13-pcs.

With belt clip.  
Blister packed.

Order-No.	Series	
39052	SB 7947-065	10

## HOT Torsion bits.



**NEW**

**7947-055** FlipSelector Torsion HOT, assorted, 13-pcs.

Housing: Box of impact resistant, glass-fibre reinforced polyamide - permanently robust.

Bit clamping element can be swivelled 180°. Extra folding element for the magnetic bit holder.

Bits: 25 mm HOT Torsion bits.

Geometry: Patented torsion zone to prevent premature breaking of the bit when under stress.

Bit holder: 1/4" universal holder, magnetic.

Application: Compact bit box with 12 high quality bits.

Slide the Wiha logo down – and the bits are immediately available for removal.

Particularly suitable for turning screws in wood and soft materials.

Extra: Design tried and tested a million times

Always ready to use - easily fits into trouser pockets or the belt clip.

Order-No.	Series				
39031	7947-055				10
	7113 S	1xUniversal holder 58 mm, magnetic			
	⓪ 7010 HOT	1x5.5			
	⊕ 7011 HOT	1xPH1	3xPH2	1xPH3	
	⊗ 7012 HOT	1xPZ1	4xPZ2	1xPZ3	

**NEW**

**SB 7947-055** FlipSelector Torsion HOT, assorted, 13-pcs.

With belt clip.  
Blister packed.

Order-No.	Series	
39051	SB 7947-055	10



**NEW**

**7947-955** FlipSelector Torsion HOT, assorted, 13-pcs.

Order-No.	Series				
39044	7947-955				10
	7113 S	1xUniversal holder 58 mm, magnetic			
	⊗ 7012 HOT	1xPZ1	2xPZ2	1xPZ3	
	⊗ 7015 HOT	1xT10	1xT15	2xT20	2xT25
		1xT30	1xT40		

**NEW**

**SB 7947-955** FlipSelector Torsion HOT, assorted, 13-pcs.

Blister packed.

Order-No.	Series	
39064	SB 7947-955	10

## ZOT Torsion bits.



NEW

**7947-045** FlipSelector Torsion ZOT, assorted, 13-pcs.

Housing: Box of impact resistant, glass-fibre reinforced polyamide - permanently robust.

Bit clamping element can be swivelled 180°.

Extra folding element for the magnetic bit holder.

Bits: 25 mm ZOT Torsion bits.

Geometry: Patented torsion zone to prevent premature breaking of the bit when under stress.

Bit holder: 1/4" universal holder, magnetic.

Application: Compact bit box with 13 high quality bits.

Slide the Wiha logo down - and the bits are immediately available for removal.

Particularly suitable for turning screws in metal and hard materials.

Extra: Design tried and tested a million times

Always ready to use - easily fits into trouser pockets or the belt clip.

Order-No.	Series		
39033	7947-045		10
	7113 S	1xUniversal holder 58 mm, magnetic	
	① 7010 ZOT	1x5.5	
	⊕ 7011 ZOT	1xPH1	3xPH2 1xPH3
	⊕ 7012 ZOT	1xPZ1	4xPZ2 1xPZ3

NEW

**SB 7947-045** FlipSelector Torsion ZOT, assorted, 13-pcs.

With belt clip.

Blister packed.

Order-No.	Series		
39050	SB 7947-045		10



NEW

**7947-145** FlipSelector Torsion ZOT, Philips, 13-pcs.

Order-No.	Series		
39077	7947-145		10
	○ 7113 S	1xUniversal holder 58 mm, magnetic	
	⊕ 7011 ZOT	2xPH1	8xPH2 2xPH3

NEW

**SB 7947-145** FlipSelector Torsion ZOT, Philips, 13-pcs.

With belt clip.

Blister packed.

Order-No.	Series		
39081	SB 7947-145		10

## ZOT Torsion bits.



NEW

**7947-245** FlipSelector Torsion ZOT, Pozidriv, 13-pcs.

Order-No.	Series		
39036	7947-245		10
	7113 S	1xUniversal holder 58 mm, magnetic	
	⊕ 7012 ZOT	2xPZ1	8xPZ2 2xPZ3

NEW

**SB 7947-245** FlipSelector Torsion ZOT, Philips, 13-pcs.

With belt clip.

Blister packed.

Order-No.	Series		
39055	SB 7947-245		10



NEW

**7947-945** FlipSelector Torsion ZOT, assorted, 13-pcs.

Order-No.	Series		
39043	7947-945		10
	7113 S	1xUniversal holder 58 mm, magnetic	
	⊕ 7012 ZOT	1xPZ1	2xPZ2 1xPZ3
	⊕ 7015 ZOT	1xT10	1xT15 2xT20 2xT25
		1xT30	1xT40

NEW

**SB 7947-945** FlipSelector Torsion ZOT, assorted, 13-pcs.

With belt clip.

Blister packed.

Order-No.	Series		
39063	SB 7947-945		10

# Wiha FlipSelector.

Couldn't be smaller!

## Standard bits.



**NEW**  
**7947-005**

**FlipSelector Standard, assorted, 13-pcs.**

Housing: Box of impact resistant, glass-fibre reinforced polyamide - permanently robust.

Bit clamping element can be swivelled 180°. Extra folding element for the magnetic bit holder.

Bits: 25 mm Standard bits.

Bit holder: 1/4" universal holder, magnetic.

Application: Compact bit box with 12 high quality bits. Slide the Wiha logo down – and the bits are immediately available for removal.

All types of fastening in trade and industry.

Extra: Design tried and tested a million times. Always ready to use - easily fits into trouser pockets or the belt clip.

Order-No.	Series				
39029	7947-005				10
	7113 S	1xUniversal holder 58 mm, magnetic			
	⓪ 7010 Z	1x5.5			
	⊕ 7011 Z	1xPH1	3xPH2	1xPH3	
	⊕ 7012 Z	1xPZ1	4xPZ2	1xPZ3	

**NEW**  
**SB 7947-005**

**FlipSelector Standard, assorted, 13-pcs.**

With belt clip.  
Blister packed.

Order-No.	Series	
39049	SB 7947-005	10



**NEW**  
**7947-904**

**FlipSelector Standard, assorted, 13-pcs.**

Order-No.	Series				
39040	7947-904				10
	7113 S	1xUniversal holder 58 mm, magnetic			
	⊕ 7011 Z	2xPH2			
	⊕ 7012 Z	1xPZ1	2xPZ2	1xPZ3	
	⊕ 7015 Z	1xT10	1xT15	1xT20	1xT25
		1xT30	1xT40		

**NEW**  
**SB 7947-904**

**FlipSelector Standard, assorted, 13-pcs.**

With belt clip.  
Blister packed.

Order-No.	Series	
39060	SB 7947-904	10

## Standard bits.



**NEW**  
**7947-905**

**FlipSelector Standard, assorted, 13-pcs.**

Order-No.	Series				
39041	7947-905				10
	7113 S	1xUniversal holder 58 mm, magnetic			
	⊕ 7012 Z	1xPZ1	2xPZ2	1xPZ3	
	⊕ 7015 Z	1xT10	1xT15	2xT20	2xT25
		1xT30	1xT40		

**NEW**  
**SB 7947-905**

**FlipSelector Standard, assorted, 13-pcs.**

With belt clip.  
Blister packed.

Order-No.	Series	
39061	SB 7947-905	10



**NEW**  
**7947-999**

**FlipSelector Standard, assorted, 13-pcs.**

Housing: Box of impact resistant, glass-fibre reinforced polyamide - permanently robust.

Bit clamping element can be swivelled 180°.

Extra folding element for the magnetic bit holder.

Bits: 25 mm Standard bits.

Bit holder: 1/4" universal holder, magnetic.

Application: Compact bit box with 12 high quality bits.

Slide the Wiha logo down – and the bits are immediately available for removal.

All types of fastening in trade and industry.

Extra: Design tried and tested a million times

Always ready to use - easily fits into trouser pockets or the belt clip.

Order-No.	Series				
39078	7947-999				10
	7113 S	1xUniversal holder 58 mm, magnetic			
	⓪ 7010 Z	1x5.5			
	⊕ 7011 Z	1xPH2			
	⊕ 7012 Z	1xPZ1	1xPZ2	1xPZ3	
	⊕ 7015 Z	1xT15	1xT20	1xT25	1xT30
	⊕ 7013 Z	1x3.0	1x4.0	1x5.0	

**NEW**  
**SB 7947-999**

**FlipSelector Standard, assorted, 13-pcs.**

With belt clip.  
Blister packed.

Order-No.	Series	
39083	SB 7947-999	10

## Standard bits.



NEW

**7947-505** FlipSelector Standard, TORX®, 13-pcs.

Housing: Box of impact resistant, glass-fibre reinforced polyamide - permanently robust.

Bit clamping element can be swivelled 180°. Extra folding element for the magnetic bit holder.

Bits: 25 mm Standard bits.

Bit holder: 1/4" universal holder, magnetic.

Application: Compact bit box with 12 high quality bits. Slide the Wiha logo down – and the bits are immediately available for removal.

Extra: All types of fastening in trade and industry.

Design tried and tested a million times. Always ready to use - easily fits into trouser pockets or the belt clip.

Order-No.	Series				
39124	7947-505	10			
	7113 S	1xUniversal holder 58 mm, magnetic			
	7015 Z	1xT7	1xT8	1xT9	1xT10
		2xT15	2xT20	2xT25	1xT30
		1xT40			

NEW

**SB 7947-505** FlipSelector Standard, TORX®, 13-pcs.

With belt clip.  
Blister packed.

Order-No.	Series	
39056	SB 7947-505	10



NEW

**7947-505TR** FlipSelector Standard, TORX® H, 13-pcs.

Order-No.	Series				
39037	7947-505TR	10			
	7113 S	1xUniversal holder 58 mm, magnetic			
	7015 Z TR	1xT7H	1xT8H	1xT9H	1xT10H
		2xT15H	2xT20H	2xT25H	1xT30H
		1xT40H			

NEW

**SB 7947-505TR** FlipSelector Standard, TORX® H, 13-pcs.

With belt clip.  
Blister packed.

Order-No.	Series	
39057	SB 7947-505TR	10

## Standard bits.



NEW

**7947-902** FlipSelector Standard, hex, 11-pcs.

Housing: Box of impact resistant, glass-fibre reinforced polyamide - permanently robust. With hex bits up to size 8 mm.

Order-No.	Series				
39039	7947-902	10			
	7113 S	1xUniversal holder 58 mm, magnetic			
	7013 Z	1x1.5	1x2.0	1x2.5	2x3.0
		2x4.0	1x5.0	1x6.0	1x8.0

NEW

**SB 7947-902** FlipSelector Standard, hex, 11-pcs.

With belt clip.  
Blister packed.

Order-No.	Series	
39059	SB 7947-902	10



NEW

**7947-995** FlipSelector Standard, SIT, 13-pcs.

Housing: Box of impact resistant, glass-fibre reinforced polyamide - permanently robust.

Bit clamping element can be swivelled 180°. Extra folding element for the magnetic bit holder.

Bits: 25 mm Standard bits.

Bit holder: 1/4" universal holder, magnetic.

Application: Compact bit box with 12 high quality bits. Slide the Wiha logo down – and the bits are immediately available for removal.

Extra: All types of fastening in trade and industry.

Design tried and tested a million times

Always ready to use - easily fits into trouser pockets or the belt clip.

Mit Bits passend für ASSY®- und Plas-Schrauben.

Order-No.	Series				
39045	7947-995	10			
	7113 S	1xUniversal holder 58 mm, magnetic			
	7019 Z SIT	2xSIT 10	4xSIT 20	3xSIT 25	2xSIT 30
			1xSIT 40		

NEW

**SB 7947-995** FlipSelector Standard, SIT, 13-pcs.

With belt clip.  
Blister packed.

Order-No.	Series	
39082	SB 7947-995	10

# Wiha FlipSelector.

Couldn't be smaller!

## Inkra® and stainless steel bits.



**NEW**

**7947-015** FlipSelector Inkra, assorted, 13-pcs.

Housing: Box of impact resistant, glass-fibre reinforced polyamide - permanently robust.

Bit clamping element can be swivelled 180°. Extra folding element for the magnetic bit holder.

Bits: 25 mm Inkra bits.

Fastening possible at slightly oblique angles.

Bit holder: 1/4" universal holder, magnetic.

Application: Compact bit box with 12 high quality bits.

Slide the Wiha logo down – and the bits are immediately available for removal. The ideal bits for all hard-to-reach places, especially suitable for wood screws.

Extra: Design tried and tested a million times

Always ready to use - easily fits into trouser pockets or the belt clip.

Order-No.	Series	
39048	7947-015	10
	7113 S	1xUniversal holder 58 mm, magnetic
	⊕ 7011 Inkra	1xPH1 4xPH2 1xPH3
	⊕ 7012 Inkra	1xPZ1 4xPZ2 1xPZ3

**NEW**

**SB 7947-015** FlipSelector Inkra, assorted, 13-pcs.

With belt clip. Blister packed.

Order-No.	Series	
39067	SB 7947-015	10



**NEW**

**7947-0ST5** FlipSelector stainless steel, assorted, 13-pcs.

Housing: 25 mm stainless steel bits.

Ideally suitable for fastening and unfastening of stainless steel screws.

Order-No.	Series	
39035	7947-0ST5	10
	7148ST	1xCentroFix Edelstahl-Schnellwechselhalter
	Ⓛ 7010ST	1x5.5
	⊕ 7011ST	1xPH1 3xPH2 1xPH3
	⊕ 7012ST	1xPZ1 4xPZ2 1xPZ3

**NEW**

**SB 7947-0ST5** FlipSelector stainless steel, assorted, 13-pcs.

With belt clip. Blister packed.

Order-No.	Series	
39054	SB 7947-0ST5	10

## Stainless steel bits.



**NEW**

**7947-9ST4** FlipSelector stainless steel, assorted, 13-pcs.

Housing: Box of impact resistant, glass-fibre reinforced polyamide - permanently robust.

Bit clamping element can be swivelled 180°.

Extra folding element for the magnetic bit holder.

Bits: 25 mm stainless steel bits.

Ideally suitable for fastening and unfastening of stainless steel screws.

Bit holder: CentroFix stainless steel quick release holder, style E 6.3.

Application: Compact bit box with 12 high quality bits.

Slide the Wiha logo down – and the bits are immediately available for removal.

Extra: Design tried and tested a million times

Always ready to use - easily fits into trouser pockets or the belt clip.

Order-No.	Series	
39047	7947-9ST4	10
	7148ST	1xCentroFix stainless steel quick release holder, E 6.3
	⊕ 7011ST	2xPH2
	⊕ 7012ST	1xPZ1 2xPZ2 1xPZ3
	⊕ 7015ST	1xT10 1xT15 1xT20 1xT25
		1xT30 1xT40

**NEW**

**SB 7947-9ST4** FlipSelector stainless steel, assorted, 13-pcs.

With belt clip. Blister packed.

Order-No.	Series	
39066	SB 7947-9ST4	10



**NEW**

**7947-5ST5** FlipSelector stainless steel, assorted, 13-pcs.

Housing: 25 mm stainless steel bits.

Ideally suitable for fastening and unfastening of stainless steel screws.

Order-No.	Series	
39038	7947-5ST5	10
	7148ST	1xCentroFix stainless steel quick release holder, E 6.3
	⊕ 7015 Z	1xT8 1xT9
	⊕ 7015ST	1xT10 2xT15 3xT20 2xT25
		1xT30 1xT40

**NEW**

**SB 7947-5ST5** FlipSelector stainless steel, assorted, 13-pcs.

With belt clip. Blister packed.

Order-No.	Series	
39058	SB 7947-5ST5	10



Belt clip. FlipSelector sales counter display.



**7945** Belt clip for BitBuddy® and FlipSelector.  
Suitable for Buddy 29 and Buddy 49 and FlipSelector.  
Material: High quality, impact resistant plastic.

Order-No.	Series	
36990		10

FlipSelector sales counter display.



**NEW**  
**7947 VB2** FlipSelector display.  
Sales display with 10 pieces.

Order-No.	Series	
39087	7947 VB2	10
⊕ ⊕ ⊕	7947-904	FlipSelector Standard, assorted, 13-pcs. 7113 S: Universal holder 58 mm, magnetic 7011 Z: 2xPH2 7012 Z: 1xPZ1 2xPZ2 1xPZ3 7015 Z: 1xT10 1xT15 1xT20 1xT25 1xT30 1xT40



**NEW**  
**7947 VB3** FlipSelector display.  
Sales display with 10 pieces.

Order-No.	Series	
39088	7947 VB3	10
⊕	7947-505	FlipSelector Standard, TORX®, 13-pcs. 7113 S: Universal holder 58 mm, magnetic 7015 Z: 1xT7 1xT8 1xT9 1xT10 2xT15 2xT20 2xT25 1xT30 1xT40



**NEW**  
**7947 VB4** FlipSelector display.  
Sales display with 10 pieces.

Order-No.	Series	
39089	7947 VB4	10
⊕ ⊕ ⊕	7947-045	FlipSelector Torsion ZOT, assorted, 13-pcs. 7113 S: Universal holder 58 mm, magnetic 7010 ZOT: 1x5,5 7011 ZOT: 1xPH1 3xPH2 1xPH3 7012 ZOT: 1xPZ1 4xPZ2 1xPZ3



**NEW**  
**7947 VB5** FlipSelector display.  
Sales display with 10 pieces.

Order-No.	Series	
39090	7947 VB5	10
⊕ ⊕ ⊕	7947-055	FlipSelector Torsion HOT, assorted, 13-pcs. 7113 S: Universal holder 58 mm, magnetic 7010 HOT: 1x5,5 7011 HOT: 1xPH1 3xPH2 1xPH3 7012 HOT: 1xPZ1 4xPZ2 1xPZ3



**NEW**  
**7947 VB1** FlipSelector display.  
Sales display with 10 pieces.

Order-No.	Series	
39086	7947 VB1	10
⊕ ⊕ ⊕	7947-005	FlipSelector Standard, assorted, 13-pcs. 7113 S: Universal holder 58 mm, magnetic 7010 Z: 1x5,5 7011 Z: 1xPH1 3xPH2 1xPH3 7012 Z: 1xPZ1 4xPZ2 1xPZ3



# Wiha Collector.

Everything in one box.



A completely new look, and outstandingly equipped: the new Wiha Collector sets standards for convenient application of the bits.

The first impression convinces: the box is compact, solid and surprises with an innovative opening mechanism. The Collector opens up like a book with the easy-to-use button. The bits are clearly laid out, easy to remove and yet so firmly held that they cannot fall out if the box is accidentally knocked over.

And talking of bits: the assortment is designed perfectly for all applications. Whether for special work in safety areas or for everyday tasks in trade and industry, the Wiha Collector is ready and waiting.



*Versatile: for up to 60 bits as well as universal and quick release holders.*



*Innovative opening, and lots of space: the new Collector.*



## Wiha Collector.

- **Tough**  
Compact form, tough polycarbonate
- **Easy to open**  
With practical unlocking button - for when only one hand is free
- **Lots of space**  
30 premium bits with bit holder and hand-held screwdriver or 60 premium bits with bit holder
- **Diverse**  
Security bits or tried-and-true Standard bits for all applications
- **Optimal seating of bits**  
Easy to remove and yet still firmly held

## Security-bits.

**7928-928** Bit Collector Security, mixed, 27 pcs.

Housing: Robust box made of high-tensile plastic.  
The box opens automatically at the press of a button.

Handle: Wiha SoftFinish® multi-component handle, magnetic, with 1/4" bit mount.

Bits: 25 mm Standard and Torsion bits, TORX® Tamper Resistant, Tri-Wing®, Torq-Set®, Spanner, hex Tamper Resistant.

Bit holder: Universal holder, magnetic.

Application: Bit cassette with bits for all popular security screws.

Order-No.	Series				
09393	7928-928	5			
	7015 Z TR	1xT8H	1xT10H	1xT15H	1xT20H
		1xT25H	1xT27H	1xT30H	1xT40H
	7019 ZOT TS	1x6	1x8	1x10	
	7019 ZOT TW	1x1	1x2	1x3	1x4
	7019 Z SP	1x4	1x6	1x8	1x10
	7013 Z TR	1xTR5/64	1xTR3/32	1xTR7/64	1xTR1/8
		1xTR9/64	1xTR5/32		
	7113 S	1xUniversal holder 58 mm, magnetic			
	281-02	1xBit holder with handle, magnetic, 1/4"			

## Standard bits.

**7928-913** Bit Collector Standard, mixed, 32 pcs.

Housing: Robust box made of high-tensile plastic.  
The box opens automatically at the press of a button.

Handle: Wiha SoftFinish® multi-component handle, magnetic, with 1/4" bit mount.

Bits: 25 mm Standard bits.

Bit holder: CentroFix Force quick release holder, magnetic.

Application: Can be used immediately for both machine and hand operation with handle and bit holder.

Order-No.	Series				
34686	7928-913	5			
	7010 Z	1x4.5	1x5.5	1x6.5	
	7011 Z	2xPH1	5xPH2	2xPH3	
	7012 Z	2xPZ1	5xPZ2	2xPZ3	
	7015 Z	1xT10	1xT15	1xT20	1xT25
		1xT30	1xT40		
	7013 Z	1x4.0	1x5.0	1x6.0	
	281-02	1xBit holder with handle, magnetic, 1/4"			
	7148 CF	1xCentroFix Force quick release holder, magnetic, style E 6.3			

**7928-923** Bit Collector Standard, mixed, 61 pcs.

Housing: Robust box made of high-tensile plastic.  
The box opens automatically at the press of a button.

Bits: 25 mm Standard bits.

Bit holder: CentroFix Force quick release holder, magnetic.

Application: The complete bit assortment for every professional.

Order-No.	Series				
07943	7928-923	5			
	7010 Z	1x4.5	1x5.5	1x6.5	1x8.0
	7011 Z	7xPH1	13xPH2	3xPH3	
	7012 Z	7xPZ1	13xPZ2	3xPZ3	
	7015 Z	1xT10	1xT15	1xT20	1xT25
		1xT30	1xT40		
	7013 Z	1x3.0	1x4.0	1x5.0	1x6.0
	7148 CF	1xCentroFix Force quick release holder, magnetic, style E 6.3			

# Wiha bit cassette and bulk packs.

## Bit cassette.



### 7979-01 Standard bit case, mixed, 31 pcs.

Housing: Practical, rugged plastic box.

Bits: 25 mm Standard bits.

Bit holder: Universal holder, magnetic.

Order-No.	Series				
26252	7979-01	10			
①	7010 Z	1x4.5	1x5.5	1x6.5	
⊕	7011 Z	2xPH1	6xPH2	1xPH3	
⊕	7012 Z	2xPZ1	6xPZ2	1xPZ3	
⊗	7015 Z	1xT10	1xT15	1xT20	1xT25
		1xT30	1xT40		
⊙	7013 Z	1x4.0	1x5.0	1x6.0	
	7113 S	1xUniversal holder 58 mm, magnetic			



### 7979-02 Standard bit case, mixed, 31 pcs.

Housing: Practical, rugged plastic box.

Bits: 25 mm Standard bits.

Bit holder: Universal holder, magnetic.

Order-No.	Series				
26253	7979-02	10			
⊕	7012 Z	5xPZ1	10xPZ2	3xPZ3	
⊗	7015 Z	2xT10	2xT15	2xT20	2xT25
		2xT30	2xT40		
	7113 S	1xUniversal holder 58 mm, magnetic			



### 7979-03 Standard bit case, mixed, 31 pcs.

Housing: Practical, rugged plastic box.

Bits: 25 mm Standard bits.

Bit holder: Universal holder, magnetic.

Order-No.	Series				
36310	7979-03	10			
⊕	7012 Z	2xPZ1	3xPZ2	1xPZ3	
⊗	7015 Z	2xT10	6xT15	6xT20	6xT25
		2xT30	2xT40		
	7113 S	1xUniversal holder 58 mm, magnetic			

## Bit bulk pack TiN.



### 7929 TiN Bit bulk pack TiN, 25 mm, 50 pcs.

Packaging: Practical cardboard box. Can be used as a dispenser in the workplace.

Bits: 25 mm TiN Torsion bits.

Geometry: Unmixed, available in the standard Phillips, Pozidriv and TORX® sizes.

Torsion zone for protecting against premature breakage of bits under load.

Coating: Titanium nitride for extended tool life.

Application: Especially for professional needs.

Order-No.	Content	Quantity	
08053	⊕ 7011 TiN	50	PH1 x 25
08054	⊕ 7011 TiN	50	PH2 x 25
08055	⊕ 7011 TiN	50	PH3 x 25
08062	⊕ 7012 TiN	50	PZ1 x 25
08063	⊕ 7012 TiN	50	PZ2 x 25
08064	⊕ 7012 TiN	50	PZ3 x 25
33672	⊗ 7015 TiN	50	T10 x 25
33673	⊗ 7015 TiN	50	T15 x 25
33674	⊗ 7015 TiN	50	T20 x 25
33675	⊗ 7015 TiN	50	T25 x 25
33676	⊗ 7015 TiN	50	T30 x 25

### Bit bulk pack HOT.



#### 7929 HOT Bit bulk pack HOT, 25 mm, 50 pcs.

**Packaging:** Practical cardboard box. Can be used as a dispenser in the workplace.  
**Bits:** 25 mm HOT Torsion bits.  
 Unmixed, available in the standard Phillips, Pozidriv and TORX® sizes.  
**Geometry:** Torsion zone for protecting against premature breakage of bits under load.  
**Application:** Especially for professional needs.

Order-No.	Content	Quantity
-----------	---------	----------

08050	⊕ 7011 HOT	50	PH1 x 25
08051	⊕ 7011 HOT	50	PH2 x 25
08052	⊕ 7011 HOT	50	PH3 x 25
08059	⊕ 7012 HOT	50	PZ1 x 25
08060	⊕ 7012 HOT	50	PZ2 x 25
08061	⊕ 7012 HOT	50	PZ3 x 25
33677	⊕ 7015 HOT	50	T20 x 25
33678	⊕ 7015 HOT	50	T25 x 25
33679	⊕ 7015 HOT	50	T30 x 25

### Bit bulk pack ZOT.



#### 7929 ZOT Bit bulk pack ZOT, 25 mm, 50 pcs.

**Packaging:** Practical cardboard box. Can be used as a dispenser in the workplace.  
**Bits:** 25 mm ZOT Torsion bits.  
 Unmixed, available in the standard Phillips and Pozidriv sizes.  
**Geometry:** Patented torsion zone to prevent premature breaking of the bit when under stress.  
**Application:** Especially for professional needs.

Order-No.	Content	Quantity
-----------	---------	----------

29875	⊕ 7011 ZOT	50	PH1 x 25
29876	⊕ 7011 ZOT	50	PH2 x 25
29877	⊕ 7011 ZOT	50	PH3 x 25
29878	⊕ 7012 ZOT	50	PZ1 x 25
29879	⊕ 7012 ZOT	50	PZ2 x 25
29880	⊕ 7012 ZOT	50	PZ3 x 25

### Bit bulk pack Inkra.



#### 7929 Inkra Bit bulk pack Inkra, 25 mm, 50 pcs.

**Packaging:** Practical cardboard box. Can be used as a dispenser in the workplace.  
**Bits:** 25 mm Inkra bits.  
 Unmixed, available in the standard Phillips and Pozidriv sizes.  
**Geometry:** The ideal bit for areas that are difficult to access, particularly suitable for wood screws.  
**Coating:** Non-corrosive coating.  
**Application:** Especially for professional needs.

Order-No.	Content	Quantity
-----------	---------	----------

31990	⊕ 7011 Inkra	50	PH1 x 25
31991	⊕ 7011 Inkra	50	PH2 x 25
31992	⊕ 7011 Inkra	50	PH3 x 25
31993	⊕ 7012 Inkra	50	PZ1 x 25
31994	⊕ 7012 Inkra	50	PZ2 x 25
31995	⊕ 7012 Inkra	50	PZ3 x 25

### Bit bulk pack Standard.



#### 7929 Z Bit bulk pack Standard, 25 mm, 50 pcs.

**Packaging:** Practical cardboard box. Can be used as a dispenser in the workplace.  
**Bits:** 25 mm Standard bits.  
 Unmixed, available in the standard Phillips, Pozidriv and TORX® sizes.  
**Application:** Especially for professional needs.

Order-No.	Content	Quantity
-----------	---------	----------

08047	⊕ 7011 Z	50	PH1 x 25
08048	⊕ 7011 Z	50	PH2 x 25
08049	⊕ 7011 Z	50	PH3 x 25
08056	⊕ 7012 Z	50	PZ1 x 25
08057	⊕ 7012 Z	50	PZ2 x 25
08058	⊕ 7012 Z	50	PZ3 x 25
08065	⊕ 7015 Z	50	T10 x 25
08066	⊕ 7015 Z	50	T15 x 25
08067	⊕ 7015 Z	50	T20 x 25
08068	⊕ 7015 Z	50	T25 x 25
29544	⊕ 7015 Z	50	T27 x 25
08069	⊕ 7015 Z	50	T30 x 25
08070	⊕ 7015 Z	50	T40 x 25



# Wiha SB bit programme.

Full programme range in outstanding quality.



## Style C 6.3 and E 6.3 (1/4").

You can display the bits effectively in the practical Wiha plastic boxes.

The bits are easily recognisable in the dust-repellent, transparent packaging. In addition, the labels provide all necessary information and at the same time ensure protection against theft. Contents, EAN code, article number and order number - everything can be seen at a glance with the large-format symbols.

A comprehensive range: the Wiha SB bit range includes more than 100 different items.



### Wiha SB bit programme.

- Full size label with viewing window allows a view of box contents
- Large, clearly laid out description of quality, size and quantity
- Reusable plastic box
- Full assortment
- Slotted, Phillips, Pozidriv, hexagonal and TORX® drives, various bit holders and tool shafts
- In bit types: Dura, Diamond, TiN, HOT, ZOT, Inkra and Standard
- 1 pc, 2 pcs, 3 pcs, 6 pcs and 10 pcs







-  Wiha DuraBit®
-  Wiha TiN-Torsions-Bit
-  Wiha ZOT-Torsions-Bit
-  Wiha Professional-Bits
-  Wiha Standard-Bit



### 7010 Slotted bits in a plastic box.

Packaging: Plastic box, reusable and dust repellent.

Extra: Easily identifiable content with large symbols.

Order-No.	Content	Quantity	
<b>DuraBit with torsion zone 25 mm</b>			
24713	⊕ 7010 DR	3	4,5x25 5,5x25 6,5x25 
<b>TiN Torsion bit 25 mm</b>			
08455	⊕ 7010 TiN	3	4,5x25 5,5x25 6,5x25 
<b>ZOT Torsion bit 25 mm</b>			
08454	⊕ 7010 ZOT	3	4,5x25 5,5x25 6,5x25
09496	⊕ 7010 ZOT	6	5,5x25 6,5x25 PH1x25 PH2x25 PZ1x25 PZ2x25 
<b>Professional bit 50 mm</b>			
08419	⊕ 7040 Z	3	3,0x50 3,5x50 4,0x50
08420	⊕ 7040 Z	3	5,5x50 6,5x50 8,0x50
<b>Standard bit 25 mm</b>			
07863	⊕ 7010 Z	2	4,5x25 5,5x25
07864	⊕ 7010 Z	2	6,5x25 8,0x25
08453	⊕ 7010 Z	3	4,5x25 5,5x25 6,5x25
09495	⊕ 7010 Z	6	5,5x25 6,5x25 PH1x25 PH2x25 PZ1x25 PZ2x25 

## Style C 6.3 and E 6.3 (1/4").

**7011** Phillips bits in a plastic box.

Packaging: Plastic box, reusable and dust repellent.

Extra: Easily identifiable content with large symbols.

Order-No.	Content	Quantity	
<b>29er® MaxxTor bit 29 mm</b>			
36812	⊕ 7011 M9T 5 PH1x29		<b>NEW</b>
36813	⊕ 7011 M9T 5 PH2x29		<b>NEW</b>
36814	⊕ 7011 M9T 5 PH3x29		<b>NEW</b>
<b>49er MaxxTor bit 49 mm</b>			
36828	⊕ 7041 M9T 5 PH1x49		<b>NEW</b>
36829	⊕ 7041 M9T 5 PH2x49		<b>NEW</b>
36830	⊕ 7041 M9T 5 PH3x49		<b>NEW</b>
<b>DuraBit with torsion zone 25 mm</b>			
33855	⊕ 7011 DR 2 PH1x25		
24727	⊕ 7041 DR 2 PH2x25		
24267	⊕ 7011 DR 2 PH2x25		
32045	⊕ 7011 DR 10 PH2x25		
33856	⊕ 7011 DR 2 PH3x25		
24269	⊕ 7011 DR 3 PH1x25 PH2x25 PH3x25		
<b>Diamond torsion bit 25 mm</b>			
22107	⊕ 7011 D 2 PH1x25		
22109	⊕ 7011 D 2 PH2x25		
36278	⊕ 7011 D 10 PH2x25		
22111	⊕ 7011 D 2 PH3x25		
22113	⊕ 7011 D 3 PH1x25 PH2x25 PH3x25		
<b>TiN Torsion bit 25 mm</b>			
07821	⊕ 7011 TiN 2 PH1x25		
07828	⊕ 7011 TiN 2 PH2x25		
36277	⊕ 7011 TiN 10 PH2x25		
07846	⊕ 7011 TiN 2 PH3x25		
07847	⊕ 7011 TiN 3 PH1x25 PH2x25 PH3x25		
<b>HOT Torsion bit 25 mm</b>			
32060	⊕ 7011 HOT 10 PH1x25		
20814	⊕ 7011 HOT 2 PH2x25		
32061	⊕ 7011 HOT 10 PH2x25		
36276	⊕ 7011 HOT 20 PH2x25		
32062	⊕ 7011 HOT 10 PH3x25		
20818	⊕ 7011 HOT 3 PH1x25 PH2x25 PH3x25		

## Style C 6.3 and E 6.3 (1/4").

Order-No.	Content	Quantity	
<b>ZOT Torsion bit 25 mm   50 mm</b>			
07876	⊕ 7011 ZOT 2 PH1x25		
36274	⊕ 7011 ZOT 10 PH1x25		
07877	⊕ 7011 ZOT 2 PH2x25		
24752	⊕ 7011 ZOT 10 PH2x25		
24754	⊕ 7011 ZOT 20 PH2x25		
07878	⊕ 7011 ZOT 2 PH3x25		
36281	⊕ 7011 ZOT 10 PH3x25		
07879	⊕ 7011 ZOT 3 PH1x25 PH2x25 PH3x25		
07887	⊕ 7041 ZOT 3 PH1x50 PH2x50 PH3x50		
<b>Inkra bit 25 mm</b>			
22318	⊕ 7011 Inkra 2 PH1x25		
22320	⊕ 7011 Inkra 2 PH2x25		
36279	⊕ 7011 Inkra 10 PH2x25		
22322	⊕ 7011 Inkra 2 PH3x25		
22649	⊕ 7011 Inkra 3 PH1x25 PH2x25 PH3x25		
<b>Stainless steel bit 25 mm</b>			
34483	⊕ 7011 ST 2 PH1x25		
34484	⊕ 7011 ST 2 PH2x25		
34485	⊕ 7011 ST 2 PH3x25		
<b>Standard bit 25 mm</b>			
07855	⊕ 7011 Z 3 PH1x25		
32055	⊕ 7011 Z 10 PH1x25		
07856	⊕ 7011 Z 3 PH2x25		
24733	⊕ 7011 Z 10 PH2x25		
35834	⊕ 7011 Z 10 PH2x25 Reduced PH profile		
36275	⊕ 7011 Z 20 PH2x25		
07857	⊕ 7011 Z 3 PH3x25		
36280	⊕ 7011 Z 10 PH3x25		
07858	⊕ 7011 Z 3 PH1x25 PH2x25 PH3x25		
<b>Professional bit 50 mm   70 mm</b>			
38676	⊕ 7041 Z 2 PH1x50		<b>NEW</b>
36193	⊕ 7041 Z 2 PH2x50		<b>NEW</b>
38677	⊕ 7041 Z 2 PH3x50		<b>NEW</b>
38706	⊕ 7041 Z 2 PH1x70		<b>NEW</b>
38707	⊕ 7041 Z 2 PH2x70		<b>NEW</b>
38708	⊕ 7041 Z 2 PH3x70		<b>NEW</b>

# Wiha SB-Bit-Programm.





Full programme range in outstanding quality.

## Style C 6.3 and E 6.3 (1/4").







### 7012 Pozidriv bits in a plastic box.

Packaging: Plastic box, reusable.  
Extra: Easily identifiable content with large symbols.

Order-No.	Content	Quantity	
<b>29er® MaxxTor bit 29 mm</b>			
36815	⊕ 7012 M9T	5	PZ1x29 <b>NEW</b>
36816	⊕ 7012 M9T	5	PZ2x29 <b>NEW</b>
36817	⊕ 7012 M9T	5	PZ3x29 <b>NEW</b>
<b>49er MaxxTor bit 49 mm</b>			
36831	⊕ 7042 M9T	5	PZ1x49 <b>NEW</b>
36832	⊕ 7042 M9T	5	PZ2x49 <b>NEW</b>
36833	⊕ 7042 M9T	5	PZ3x49 <b>NEW</b>
<b>DuraBit with torsion zone 25 mm</b>			
33857	⊕ 7012 DR	2	PZ1x25 
24271	⊕ 7012 DR	2	PZ2x25
32046	⊕ 7012 DR	10	PZ2x25
33858	⊕ 7012 DR	2	PZ3x25
24273	⊕ 7012 DR	3	PZ1x25 PZ2x25 PZ3x25
<b>Diamond torsion bit 25 mm</b>			
22115	⊕ 7012 D	2	PZ1x25 
22117	⊕ 7012 D	2	PZ2x25
36283	⊕ 7012 D	10	PZ2x25
22119	⊕ 7012 D	2	PZ3x25
22121	⊕ 7012 D	3	PZ1x25 PZ2x25 PZ3x25
<b>DuraBit with torsion zone 50 mm</b>			
24738	⊕ 7042 DR	2	PZ2x50 
<b>TiN Torsion bit 25 mm</b>			
07848	⊕ 7012 TiN	2	PZ1x25 
07849	⊕ 7012 TiN	2	PZ2x25
35388	⊕ 7012 TiN	10	PZ2x25
07850	⊕ 7012 TiN	2	PZ3x25
07851	⊕ 7012 TiN	3	PZ1x25 PZ2x25 PZ3x25
<b>HOT Torsion bit 25 mm</b>			
20820	⊕ 7012 HOT	2	PZ1x25 
32057	⊕ 7012 HOT	10	PZ1x25
20822	⊕ 7012 HOT	2	PZ2x25
32058	⊕ 7012 HOT	10	PZ2x25
35387	⊕ 7012 HOT	20	PZ2x25
20824	⊕ 7012 HOT	2	PZ3x25
32059	⊕ 7012 HOT	10	PZ3x25
20827	⊕ 7012 HOT	3	PZ1x25 PZ2x25 PZ3x25



## Style C 6.3 and E 6.3 (1/4").

Order-No.	Content	Quantity	
<b>ZOT Torsion bit 25 mm   50 mm</b>			
07880	⊕ 7012 ZOT	2	PZ1x25 
36173	⊕ 7012 ZOT	10	PZ1x25
07881	⊕ 7012 ZOT	2	PZ2x25
24756	⊕ 7012 ZOT	10	PZ2x25
24758	⊕ 7012 ZOT	20	PZ2x25
07882	⊕ 7012 ZOT	2	PZ3x25
36286	⊕ 7012 ZOT	10	PZ3x25
07883	⊕ 7012 ZOT	3	PZ1x25 PZ2x25 PZ3x25
07888	⊕ 7042 ZOT	3	PZ1x50 PZ2x50 PZ3x50
<b>Professional bit 70 mm</b>			
36086	⊕ 7049 XZ	2	SL/PZ1x70 <b>NEW</b>
36082	⊕ 7049 XZ	2	SL/PZ2x70 <b>NEW</b>
<b>Inkra bit</b>			
22324	⊕ 7012 Inkra	2	PZ1x25 
22326	⊕ 7012 Inkra	2	PZ2x25
36284	⊕ 7012 Inkra	10	PZ2x25
22328	⊕ 7012 Inkra	2	PZ3x25
22647	⊕ 7012 Inkra	3	PZ1x25 PZ2x25 PZ3x25
<b>Stainless steel bit 25 mm</b>			
34486	⊕ 7012 ST	2	PZ1x25 
34487	⊕ 7012 ST	2	PZ2x25
34488	⊕ 7012 ST	2	PZ3x25
<b>Standard bit 25 mm</b>			
07859	⊕ 7012 Z	3	PZ1x25 
32070	⊕ 7012 Z	10	PZ1x25
35709	⊕ 7012 Z	20	PZ1x25
07860	⊕ 7012 Z	3	PZ2x25
24742	⊕ 7012 Z	10	PZ2x25
36285	⊕ 7012 Z	10	PZ2x25 reduced PZ-Profil
36282	⊕ 7012 Z	20	PZ2x25
07861	⊕ 7012 Z	3	PZ3x25
32071	⊕ 7012 Z	10	PZ3x25
20542	⊕ 7012 Z	1	PZ4x25
07862	⊕ 7012 Z	3	PZ1x25 PZ2x25 PZ3x25
<b>Professional bit 50 mm   70 mm</b>			
38679	⊕ 7042 Z	2	PZ1x50 <b>NEW</b>
38680	⊕ 7042 Z	2	PZ2x50 <b>NEW</b>
38681	⊕ 7042 Z	2	PZ3x50 <b>NEW</b>
38709	⊕ 7042 Z	2	PZ1x70 <b>NEW</b>
38710	⊕ 7042 Z	2	PZ2x70 <b>NEW</b>
38711	⊕ 7042 Z	2	PZ3x70 <b>NEW</b>



## Style C 6.3 and E 6.3 (1/4").

**7015** TORX® bits in a plastic box.

Packaging: Plastic box, reusable.  
 Extra: Easily identifiable content with large symbols.

Order-No.	Content	Quantity	
<b>29er® MaxxTor bit 29 mm</b>			
36822	7015 M9T	5	T10x29 <b>NEW</b>
36823	7015 M9T	5	T15x29 <b>NEW</b>
36824	7015 M9T	5	T20x29 <b>NEW</b>
36825	7015 M9T	5	T25x29 <b>NEW</b>
36826	7015 M9T	5	T30x29 <b>NEW</b>
36827	7015 M9T	5	T40x29 <b>NEW</b>
<b>49er MaxxTor bit 49 mm</b>			
36838	7045 M9T	5	T10x49 <b>NEW</b>
36839	7045 M9T	5	T15x49 <b>NEW</b>
36840	7045 M9T	5	T20x49 <b>NEW</b>
36841	7045 M9T	5	T25x49 <b>NEW</b>
36842	7045 M9T	5	T30x49 <b>NEW</b>
36843	7045 M9T	5	T40x49 <b>NEW</b>
<b>DuraBit with torsion zone 25 mm</b>			
33859	7015 DR	1	T10x25 
33860	7015 DR	1	T15x25
33861	7015 DR	1	T20x25
33862	7015 DR	1	T25x25
33863	7015 DR	1	T30x25
33864	7015 DR	1	T40x25
<b>Diamond torsion bit 25 mm</b>			
22123	7015 D	1	T10x25 
22125	7015 D	1	T15x25
22127	7015 D	1	T20x25
22129	7015 D	1	T25x25
22131	7015 D	1	T30x25
22133	7015 D	1	T40x25
<b>TiN Torsion bit 25 mm</b>			
34747	7015 TiN	2	T10x25 
34748	7015 TiN	2	T15x25
34749	7015 TiN	2	T20x25
34750	7015 TiN	2	T25x25
34751	7015 TiN	2	T30x25
34752	7015 TiN	2	T40x25

## Style C 6.3 and E 6.3 (1/4").

Order-No.	Content	Quantity	
<b>Professional bit 50 mm   70 mm</b>			
32805	7045BE	1	T20x50 
32806	7045BE	1	T25x50
07874	7045 Z	3	T10x50 T15x50 T20x50
07875	7045 Z	3	T25x50 T30x50 T40x50
32807	7045BE	3	T20x50 T25x50 T30x50
32808	7045BE	1	T20x70
32809	7045BE	1	T25x70
<b>Standard bit 25 mm</b>			
35832	7015 Z	10	T10x25 
34746	7015 Z	10	T15x25
24746	7015 Z	10	T20x25
24748	7015 Z	10	T25x25
24750	7015 Z	10	T30x25
36288	7015 Z	10	T40x25
<b>Stainless steel bit 25 mm</b>			
34489	7015 ST	2	T10x25
34490	7015 ST	2	T15x25
34491	7015 ST	2	T20x25
34492	7015 ST	2	T25x25
34493	7015 ST	2	T30x25
34494	7015 ST	2	T40x25

Order-No.	Content	Quantity	
<b>Standard bit 25 mm</b>			
08421	7015 Z	2	T10x25
08422	7015 Z	2	T15x25 
08423	7015 Z	2	T20x25
08424	7015 Z	2	T25x25
26451	7015 Z	2	T27x25
08425	7015 Z	2	T30x25
08426	7015 Z	2	T40x25
22640	7015 Z	2	T7x25 T8x25
22641	7015 Z	2	T9x25 T10x25
22643	7015 Z	2	T15x25 T20x25
22645	7015 Z	2	T25x25 T27x25
07870	7015 Z	3	T7x25 T8x25 T9x25
07871	7015 Z	3	T10x25 T15x25 T20x25
31913	7015 Z	3	T15x25 T20x25 T25x25
07872	7015 Z	3	T25x25 T30x25 T40x25
07873	7015 Z	6	T10x25 T15x25 T20x25

Order-No.	Content	Quantity	
<b>25 mm</b>			
38649	7015 ZTR	2	T10Hx25 <b>NEW</b> 
38650	7015 ZTR	2	T15Hx25 <b>NEW</b>
38651	7015 ZTR	2	T20Hx25 <b>NEW</b>
38652	7015 ZTR	2	T25Hx25 <b>NEW</b>
38653	7015 ZTR	2	T30Hx25 <b>NEW</b>
38654	7015 ZTR	2	T40Hx25 <b>NEW</b>

Order-No.	Content	Quantity	
<b>Professional bit 50 mm   70 mm</b>			
38684	7045 Z	2	T10x50 <b>NEW</b> 
38685	7045 Z	2	T15x50 <b>NEW</b>
38686	7045 Z	2	T20x50 <b>NEW</b>
38687	7045 Z	2	T25x50 <b>NEW</b>
38688	7045 Z	2	T27x50 <b>NEW</b>
38689	7045 Z	2	T30x50 <b>NEW</b>
38690	7045 Z	2	T40x50 <b>NEW</b>
38712	7045 Z	2	T10x70 <b>NEW</b>
38713	7045 Z	2	T15x70 <b>NEW</b>
38714	7045 Z	2	T20x70 <b>NEW</b>
38715	7045 Z	2	T25x70 <b>NEW</b>
38716	7045 Z	2	T27x70 <b>NEW</b>
38717	7045 Z	2	T30x70 <b>NEW</b>
38718	7045 Z	2	T40x70 <b>NEW</b>

# Wiha SB-Bit-Programm.

Full programme range in outstanding quality.

Style C 6.3 and E 6.3 (1/4").



Wiha MaxxTor-Bit 29

Wiha MaxxTor-Bit 49

Wiha Standard-Bit



## 70.. Hex bits in a plastic box.

Packaging: Plastic box, reusable and dust repellent.  
Extra: Easily identifiable content with large symbols.

Order-No.	Content	Quantity		
<b>29er® MaxxTor bit 29 mm</b>				
36818	● 7013 M9T	5	3.0x29	NEW
36819	● 7013 M9T	5	4.0x29	NEW
36820	● 7013 M9T	5	5.0x29	NEW
36821	● 7013 M9T	5	6.0x29	NEW
<b>49er MaxxTor bit 49 mm</b>				
36834	● 7043 M9T	5	3.0x49	NEW
36835	● 7043 M9T	5	4.0x49	NEW
36836	● 7043 M9T	5	5.0x49	NEW
36837	● 7043 M9T	5	6.0x49	NEW
<b>Standard bit 25 mm   38 mm</b>				
25681	● 7013 Z	2	4,0x25	
25679	● 7013 Z	2	5,0x25	
07865	● 7013 Z	3	2,0x25 2,5x25 3,0x25	
07866	● 7013 Z	3	4,0x25 5,0x25 6,0x25	
22651	● 7017 Z	3	2,0x38 2,5x38 3,0x38	ball end
22653	● 7017 Z	3	3,0x38 4,0x38 5,0x38	ball end
22655	● 7017 Z	3	4,0x38 5,0x38 6,0x38	ball end
<b>Standard bit 25 mm</b>				
38656	● 7013 Z	2	3,0x25	NEW
38657	● 7013 Z	2	6,0x25	NEW



## 7018 Robertson-Bits in a plastic box.

Packaging: Plastic box, reusable and dust repellent.  
Extra: Easily identifiable content with large symbols.

Order-No.	Content	Quantity		
<b>25 mm</b>				
38658	■ 7018 Z	1	1x25	NEW
38659	■ 7018 Z	2	2x25	NEW
38660	■ 7018 Z	3	3x25	NEW
38661	■ 7018 Z	3	1x25 2x25 3x25	NEW

Bit holder.



NEW

## 7148 CF CentroFix Force quick release holder, magnetic, style E 6.3.

Sleeve: Steel hardend, coated.  
Drive: DIN 3126, ISO 1173, style E 6.3.  
Packaging: Plastic box, reusable.  
Application: Whenever the bit needs a secure and zero-play hold. Ideal for screw profiles (e.g. Torx) which tend to jam in the screw.  
Extra: Bit is automatically locked when inserted - SelfLock. Simple bit removal thanks to EasyOut ejection function. Robust operating sleeve of hardened steel. With strong Neodym magnet.

Order-No.	○	●	↔	▬
39133	1/4	1/4	60	10



NEW

## 7148 CS CentroFix SuperSlim quick release holder, magnetic, style E 6.3.

Sleeve: Stainless steel.  
Suitable for: For bits according to DIN 3126, ISO 1173 style C 6.3 and E 6.3.  
Drive: DIN 3126, ISO 1173, style E 6.3.  
Packaging: Plastic box, reusable.  
Application: Particularly suitable for applications in confined working environments. Ideal for screw profiles (e.g. Torx) which tend to jam in the screw.  
Extra: Bit is automatically locked when inserted - SelfLock. Simple bit removal thanks to EasyOut ejection function. Robust operating sleeve of aluminium. With strong Neodym magnet.

Order-No.	○	●	↔	▬
39134	1/4	1/4	66	10



## Bit holder.



NEW

**7123** MagicFlip Force universal holder with ring magnet, style E 6.3.

Sleeve: Steel, coated.  
 Suitable for: For bits according to DIN 3126, ISO 1173 style C 6.3.  
 Drive: DIN 3126, ISO 1173, style E 6.3.  
 Packaging: Plastic box, reusable.  
 Application: The strong Neodym ring magnet even holds long screws securely. Enables easy fastening of screws.  
 Extra: With strong Neodym magnet.  
 Particularly small ring magnet inner diameter, also suitable for drywall screws.  
 Ring magnet sleeve springs back to the last fastening phase, allowing a view of the screw head and enabling precise recessing.  
 Ring magnet sleeve can be pushed back and thus "deactivated" if required.

Order-No.				
36800	1/4	1/4	62	10

**7113 S** Universal holder, magnetic, in plastic box.

Packaging: Plastic box, reusable.  
 Extra: Easily identifiable content with large symbols.

Order-No.				
07869	1/4	1/4	58	10

## Tool shaft. Nut driver insert.

**7240** Tool shaft, in plastic box.

Packaging: Plastic box, reusable and dust repellent.  
 Extra: Easily identifiable content with large symbols.

Order-No.				
08427	1/4	1/4	50	1

**7044 M** Standard bit, nut driver insert set, magnetic, 4-pcs, in plastic box.

Packaging: Plastic box, reusable and dust repellent.  
 Application: For a secure hold on screws.  
 Extra: Easily identifiable content with large symbols.  
 With strong permanent magnet.

Order-No.	Series				
36396	7044 M				1
	7044 M	7.0x55	8.0x55	10.0x55	3/8x55

**7044 M** Standard bit, nut driver insert set, in plastic box.

Packaging: Plastic box, reusable and dust repellent.  
 Extra: Easily identifiable content with large symbols.  
 With strong permanent magnet.

Order-No.	Content	Quantity	
			<b>55 mm</b>
38719	7044 M	1	6,0x55 <b>NEW</b>
38720	7044 M	1	7,0x55 <b>NEW</b>
38721	7044 M	1	8,0x55 <b>NEW</b>
38722	7044 M	1	10,0x55 <b>NEW</b>



NEW

**7011 DWS** Drywall stop bit, Phillips, style C 6.3, in a plastic box.

Material: High grade chrome-vanadium steel, through hardened.  
 Drive: DIN 3126, ISO 1173, style C 6.3.  
 Application: The ideal bit for drywall constructors.  
 Extra: The blue ring prevents the screw from being recessed too deeply into the plasterboard.











Order-No.				
20150	PH2	25		2

# Wiha pliers.

Quality and ergonomics for professionals.



## Pliers assortment

	<b>Wiha pliers.</b> Quality and ergonomics for professionals.....	256 – 257
	<b>Overview.</b> Discover real pliers quality.....	258 – 259
	<b>Wiha Inomic®.</b> Pliers – reinvented.....	260 – 261
	<b>Wiha Inomic® VDE.</b> Completely relaxed.....	262 – 263
	<b>Wiha Professional.</b> Quality down to the last detail.....	264 – 269
	<b>Wiha Professional electric.</b> Completely reliable.....	270 – 279
	<b>Wiha Industrial.</b> Comfortable in your hand, versatile in application.....	280 – 284
	<b>Wiha Industrial electric.</b> Highest safety even for non-chromed pliers.....	285 – 288
	<b>Wiha Classic.</b> The complete workshop range.....	289 – 301
	<b>Wiha Electronic.</b> Precision for made-to-measure work.....	302 – 304
	<b>Wiha Professional ESD.</b> Precise in every detail.....	305 – 309
	<b>Wiha Professional ESD.</b> For high standards when it comes to precision and safety.....	310 – 313



# Wiha pliers.

Quality and ergonomics for professionals.

## Quality in all aspects from stripping to gripping

Maximum quality for all products - in this way Wiha meets the high demands of the user. This also holds true for the pliers assortment.

## First class material, tried-and-true processes

Selected, premium grade steel, pleasant plastic application on the handle and a manufacturing process for all aspects according to state-of-the-art quality management directives - this forms the basis for the tried-and-trusted Wiha quality. A special heat treatment and inductive hardening of highly stressed parts ensure a long lifespan.

## Even more precise? Yes!

"Functionality": this somewhat sober yet important phrase represents a host of clever ideas. As such Wiha pays attention to a precise interplay of joints and an exact processing of cutting edges and gripping surfaces.

## Ergonomics: "grippy" in the best sense of the word!

Wiha pliers are consistently designed according to the requirements of users. Proof of this is the innovative and angled form of the Wiha Inomic® pliers series. And the multi-component plier handles have also been designed according to the latest findings from the field of ergonomics. With extra wide handle backs and a well thought-out distribution of soft and hard zones they are both comfortable and easy on the hands.



## Not only new, but innovative as well

Current examples in the further development of the Wiha pliers series clearly demonstrate what the power of innovation can achieve for users:

- Wiha has perfected the interplay of technology and natural movement with the Inomic® pliers generation.

- More "bite", meaning greater cutting performance with less expenditure of effort: that's what **Wiha DynamicJoint** represents. The optimised joint construction reduces the force needed for cutting!

- The **BitCut** diagonal cutters are a real problem-solver and once again underline user proximity: If the force during cutting with heavy-duty diagonal cutters is insufficient or needs high effort, help is at hand with the simple press of a button. 200% power at the press of a button means double the cutting force or half the required hand strength – unique!

- **MagicTips**, the precision tips of high performance steel achieve more stability and safety with circlip pliers from the Classic series. The special latching function preventing jumping away of the safety rings makes them both unique and very handy!

- **OptiGrip**, optimal grip due to newly designed gripping surfaces. The 'triple-point support' protects the workpiece from twisting or slipping. Now in standard Wiha combination pliers and high leverage combination pliers.

Because that is and has always been the aim of Wiha innovations: making work with pliers safer, more energy-saving and with greater comfort. For absolutely professional results.

## Wiha quality management

The Wiha quality assurance system in accordance with ISO



9001:2008 ensures with pliers as well that only first-class products leave our factory. Continuously monitored production processes and documented organisational procedures form the basis for the excellent quality for which Wiha products are renowned.



product  
design  
award

2011

*For its outstanding design quality, the new Wiha pliers generation has received the "iF – product design award". In 2011, there was a focus on the brand image. A strong and striking product appearance is the result of consistent brand management.*

*Distinction of the new Wiha pliers generation: Convincing design quality, design and product appearance.*



reddot design award  
winner 2007

*For ergonomic and qualitative design, the Wiha Inomic® pliers were awarded not only the "iF – product design award" but the "red dot design award" as well. In addition to the red dot award, organised as part of the world's largest show for contemporary design, the iF product design award is one of the oldest and most renowned design accolades.*

*Inomic® distinctions: The levels of innovation, functionality, ergonomics and service life speak for themselves.*



product  
design  
award

2007













*Wiha Professional pliers have won the "Focus in Silver" award for outstanding design. The Stuttgart Design Center awarded the 2006 international design prize in a special energy category. Energy also determines the reference level – the key to success.*





*"Focus in Silver" award: Convincing ergonomics, surface feel and clean design lines.*







# Overview.

## Wiha pliers.

	Wiha Inomic®		Wiha Inomic® VDE		Wiha Professional		Wiha Professional electric		Wiha Industrial		Wiha Industrial electric		Wiha Classic					
	Typ		Typ		Typ		Typ		Typ		Typ		Typ					
Combination pliers					160	26704	160	26705	160	30979			160	26703				
		180	33260	180	30658	180	26707	180	26708	180	30826	180	33186	180	26706			
						200	26710	200	26711	200	30978			200	26709			
High-leverage combination pliers					200	26713	200	26714	200	32319			200	26712				
					225	26716	225	26717	225	32320	225	35465	225	26715				
Needle nose pliers, straight jaws					160	33256	160	33259	160	26719	160	26720	160	32322	160	35477	160	26718
									200	26722	200	26727	200	32323	200	33178	200	26721
Needle nose pliers, bent jaws					160	26724	160	26728	160	32324			160	26723				
					200	26726	200	26729	200	32328	200	35462	200	26725				
Flat-nose pliers					160	26731	160	26732	160	32330			160	26730				
Round-nose pliers					160	26734	160	26735	160	32332			160	26733				
Precision mechanic's needle nose pliers														160	36483			
Precision mechanic's diagonal cutters														125	36189			
Diagonal cutters for plastic														125	37402			
														160	37403			
Diagonal cutters					140	26736	140	26737	140	30975	140	38633	140	26738				
		160	33254	160	30666	160	26740	160	26741	160	30827	160	33177	160	26739			
						180	26743	180	26744	180	30976			180	26742			
Electrician's diagonal cutters								160	26745									
TriCut installation pliers								170	38552					170	38627			
Heavy-duty diagonal cutters					160	26747	160	26748	160	32333	160	38634	160	26746				
						180	26750	180	26751	180	32339	180	38635	180	26749			
						200	26753	200	26754	200	32341	200	35464	200	26752			
BiCut high performance diagonal cutters					200	38190	200	38191	200	38189			200	38060				
Heavy-duty end cutting nippers									160	36035			160	26757				
									180	36036			180	26758				
									200	36037			200	26759				
Water pump pliers, box type									180	36038			180	26760				
					250	26762	250	33520	250	32342			250	26761				
									300	36039			300	26763				
Water pump pliers with push button									180	36040			180	26764				
					250	26766	250	37450	250	32352			250	26765				
									300	36041			300	26767				
Automatic water pump pliers					250	39093							250	39091				
Cable cutter pliers								160	34743			160	38636	160	34729			
								200	34744			200	35479	200	34730			
Stripping pliers					160	26846	160	26847	160	32345	160	36711	160	26845				
Crimping pliers								145	35861					145	28330			
								180	35862					180	30066			
Classic pincers (grip, edge pliers)														180	26771			
														200	26772			
Monier pliers (rabitz pliers)														220	26773			
														250	26775			
														280	26777			
														300	29779			
Monier pliers (rabitz pliers) with handle coating														220	26774			
														250	26776			
														280	26778			
														300	26780			
Revolving punch and loop pliers					225	29550												
Revolving punch pliers					225	28402												
Corner pipe pliers, S-jaw														1"	29435			
														1½"	29436			
														2"	29437			
Corner pipe pliers, 45°														1"	29438			
														1½"	29439			
														2"	29440			
Corner pipe pliers, 90°														1"	29441			
														1½"	29442			
														2"	29443			
Grip pliers with wire cutter														180	29485			
														250	29486			
														300	29487			
Cable shears														4	Shears			
Crimping tools														5	Tools			
Stripping tools														7	Tools			

	Straight form			Angled form			Straight form			Angled form		
	Typ			Typ			Typ			Typ		
Circlip pliers – for bores	J0	8 - 13	34688	J01	8 - 13	34693	J0	8 - 13	26781	J01	8 - 13	26785
	J1	12 - 25	34689	J11	12 - 25	34694	J1	12 - 25	26782	J11	12 - 25	26786
	J2	19 - 60	34690	J21	19 - 60	34695	J2	19 - 60	26783	J21	19 - 60	26787
	J3	40 - 100	34691	J31	40 - 100	34696	J3	40 - 100	26784	J31	40 - 100	26788
	J4	85 - 140	34692	J41	85 - 140	34697	J4	85 - 140	29425	J41	85 - 140	29427
Circlip pliers – for shafts	A0	7 - 10	34698	A01	7 - 10	34703	A0	3 - 10	26789	A01	3 - 10	26794
	A1	10 - 25	34699	A11	10 - 25	34704	A1	10 - 25	26790	A11	10 - 25	26795
	A2	19 - 60	34700	A21	19 - 60	34705	A2	19 - 60	26791	A21	19 - 60	26796
	A3	40 - 100	34701	A31	40 - 100	34706	A3	40 - 100	26792	A31	40 - 100	26797
	A4	85 - 140	34702	A41	85 - 140	34707	A4	85 - 140	29428	A41	85 - 140	29429

• with latching function

	with wire trapping spring				mit Drahtthaltefeder			
		Typ				Typ		
Diagonal cutters – narrow, pointed head	•	115	33521					
		115	26814		•	118	26812	
		115	26808		•	128	26813	
Diagonal cutters – wide, pointed head	•	115	26821		•	138	26818	
		115	26822		•	138	26825	
		115	26816		•	138	26815	
Diagonal cutters – narrow, semi-rounded head		115	26826					
Diagonal cutters – wide, semi-rounded head		115	26832					
		115	26831					
Oblique cutting nippers – wide, pointed head					•	138	26833	
Oblique end cutting nippers – narrow head					•	118	26830	
– extra narrow head, 40° angled	•	110	26838					
– wide head, 29° angled	•	115	26835					
End cutting pliers – extra narrow, slender shape		110	26839					
– wide head	•	115	26840					
Needle nose pliers – straight head		120	26799					
		145	27905					
Needle nose pliers – bent		120	26802					
Round-nose pliers		120	26804					
Flat-nose pliers		120	26806					
Needle-nose pliers						135	26801	
Stripping pliers – 20 18 16 14 12 10 AWG, ø 0,81 - 2,59 mm						180	33471	
– 26 24 22 20 18 16 AWG, ø 0,4 - 1,3 mm						180	33472	

# Wiha Inomic®.

Pliers – reinvented.



product design award

2013



reddot design award winner 2013



Locking mechanism: Pliers should be transported and stored in closed position

Head of pliers made of high quality tool steel, cutting edges additionally induction hardened

Metal parts with all-round, corrosion resistant surface

Handle with ergonomic soft-grip zone made of thermoplastic elastomer (TPE) in the pressure area around the ball of the thumb

Impact-resistant tool body made of fibre-glass reinforced plastic: Low weight

The areas in the arm of the pliers that move and press against each other feature hard plastic: low abrasion

Innovative technology and as ergonomic as nature: descriptions that fit Wiha Inomic® pliers perfectly.

Firstly as an extension of the hand: firm and secure when gripping, and with a natural movement that is easy on the joints. And then progressive know-how: with high quality materials that feel soft but are relentless with components being worked upon.

Pliers have been around for ages. But never with so many ideas and intelligent details as the Wiha Inomic® pliers.



The relaxed hold when using Inomic® ensures fatigue-free work.



Fraunhofer Institut Arbeitswirtschaft und Organisation

In collaboration with the IAO Stuttgart (Institute for Industrial Engineering), a wide variety of shapes and variants for this new generation of pliers was investigated during the course of extensive studies and user tests. Gripping system, hand closure forces, jaw shapes and geometries are just a few of the points examined.



Wiha Inomic®.

- **Gentle**  
The angled form is easy on muscles, tendons and joints
- **Powerful**  
All fingers grip at the same time.
- **Robust and durable**  
Strong pliers jaws, complete zinc-nickel coating, impact resistant construction
- **Sensitive**  
Greater control with grasping via opening spring with fine resistance
- **Ergonomic**  
Like the extension of a hand: grasping is simple, firm and safe
- **Attractive**  
An appealing design

**Safety note:**

When working with cutting pliers – beware of wire ends flying away. Please wear safety glasses.

**Combination pliers.****Z 01 0 15** Combination pliers Inomic®.

**Head shape:** Extra long cutting edge for flat and round cables.  
**Design:** Serrated gripping jaws.  
 Cutting edges additionally induction hardened to approx. 64 HRC.  
 Arms of the pliers move in parallel: +25% force transfer.  
 Angled shape (23°) for fatigue-free work.  
 With opening spring and locking mechanism.  
**Material:** Pliers head of high quality C 70 tool steel.  
 Handles made of tough fibre-glass reinforced plastic, ergonomic soft grip zone in the handle.  
**Application:** For gripping, holding and cutting.  
 With improved access to the objects to be processed.

Order-No.	Typ	○	●	g	g
33260	180	3.3	2.2	155	5

**Needle nose pliers and diagonal cutters.****Z 05 0 15** Needle nose pliers Inomic®.

**Head shape:** Straight form with extra-long cutting edge.  
**Design:** Ridged gripping surfaces.  
 Cutting edges additionally induction hardened to approx. 64 HRC.  
 Arms of the pliers move in parallel: +25% force transfer.  
 Angled shape (23°) for fatigue-free work.  
 With opening spring and locking mechanism.  
**Material:** Pliers head of high quality C 70 tool steel.  
 Handles made of tough fibre-glass reinforced plastic, ergonomic soft grip zone in the handle.  
**Application:** For gripping, holding and cutting.  
 With improved access to the objects to be processed.

Order-No.	Typ	○	●	g	g
33256	160	2.5	1.6	150	5

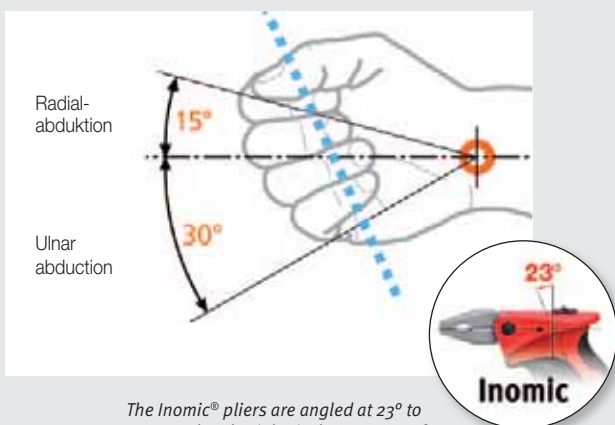

The Inomic® pliers are angled at 23° to support the physiological movement of the wrist when working and thus prevent an unhealthy wrist position, which often leads to problems such as carpal tunnel syndrome.

**Details of cutting results of cutting pliers.**

Symbol/Types of wire	Example	Tensile strength ca. N/mm <sup>2</sup>
○ Soft wire	Copper, aluminium	220 - 250
● Medium hard wire	Iron nail	750 - 800
● Hard wire	Spring wire, steel nails	1.600 - 1.800
● Piano wire	Hardened spring steel	2.200 - 2.300

Test wires standardised in DIN ISO 5744

**Z 12 0 15** Diagonal cutters Inomic®.

**Head shape:** Semi-circular, swedish style.  
**Design:** Arms of the pliers move in parallel: +25% force transfer.  
 Angled shape (23°) for fatigue-free work.  
 With opening spring and locking mechanism.  
**Material:** Pliers head of high quality C 70 tool steel.  
 Handles made of tough fibre-glass reinforced plastic, ergonomic soft grip zone in the handle.  
**Application:** For soft and hard wires.  
 With improved access to the objects to be processed.

Order-No.	Typ	○	●	g	g
33254	160	2.8	2.0	140	5

# Wiha Inomic® VDE.

Completely relaxed.



product design award



reddot design award winner 2013

2013



Locking mechanism: Pliers should be transported and stored in closed position

Head of pliers made of high quality tool steel, cutting edges additionally induction hardened

Metal parts with all-round, corrosion resistant surface

Handle with ergonomic soft-grip zone made of thermoplastic elastomer (TPE) in the pressure area around the ball of the thumb

Impact-resistant tool body made of fibre-glass reinforced plastic: Low weight

The areas in the arm of the pliers that move and press against each other feature hard plastic: low abrasion

How can maximum safety and effective working be combined with live parts? It's possible, with the Wiha Inomic® VDE.

A principle of nature has inspired Wiha for the design of this pliers range: the angled form of the pliers means the user can work without tiring limbs, sinews and muscles, and he can apply a powerful grip when cutting. That means: tiredness and aching limbs are not an issue even after hours of work.



And just to be on the safe side: Wiha Inomic® VDE pliers are regularly subjected to a wide range of stringent quality inspections, thus repeatedly confirming their high normative quality.

Safety and functionality at the highest level - and with unashamedly good looks!

The relaxed position of the hand when using Inomic® VDE ensures fatigue-free work. Guaranteed with highest electrical safety level.



Approved for work in the area of live parts up to 1,000 V AC or 1,500 V DC. When working with VDE tools, observe the national safety and accident prevention regulations.



## Wiha Inomic® VDE.

- Uncompromisingly safe**  
 Manufactured and inspected according to IEC 60900:2012, one-off testing at 10,000 V, GS mark for inspected safety, VDE tested
- Gentle**  
 The angled form is easy on muscles, tendons and joints
- Powerful**  
 All fingers grip at the same time.
- Robust and durable**  
 Strong pliers jaws, complete zinc-nickel coating, impact resistant construction
- Sensitive**  
 Greater control with grasping via opening spring with fine resistance
- Ergonomic**  
 Like the extension of a hand: grasping is simple, firm and safe
- Attractive**  
 An appealing design





**Safety note:**  
When working with cutting pliers – beware of wire ends flying away. Please wear safety glasses.

**Combination pliers.**



1000 V IEC 60900:2012

**Z 01 9 16** Combination pliers Inomic® VDE. Insulation up to 1,000 V AC, GS-mark.

- Standards: Manufactured acc. to IEC 60900:2012.
- Head shape: With cutting edge for flat and round cable.
- Design: Serrated gripping jaws. Cutting edges additionally induction hardened to approx. 62 HRC. Arms of the pliers move in parallel: +25% force transfer. Angled shape (23°) for fatigue-free work. With opening spring and locking mechanism.
- Material: Pliers head of high-quality tool steel. Handles made of tough fibre-glass reinforced plastic, ergonomic soft grip zone in the handle.
- Application: For gripping, holding and cutting. With improved access to the objects to be processed.

Order-No.	Typ	○	●	●	↔	↔
30658	180	3.5	2.5	1.6	160	5

**Needle nose pliers and diagonal cutters.**



1000 V IEC 60900:2012

**Z 06 0 16** Needle nose pliers Inomic® VDE. Insulation up to 1,000 V AC, GS-mark.

- Standards: Manufactured acc. to IEC 60900:2012.
- Head shape: Straight shape with blade and three stripping points 2.5 mm², 1.5 mm², 0.75 mm².
- Design: Ridged gripping surfaces. Cutting edges additionally induction hardened to approx. 62 HRC. Arms of the pliers move in parallel: +25% force transfer. Angled shape (23°) for fatigue-free work. With opening spring and locking mechanism.
- Material: Pliers head of high quality C 70 tool steel. Handles made of tough fibre-glass reinforced plastic, ergonomic soft grip zone in the handle.
- Application: For gripping, holding, cutting and stripping. With improved access to the objects to be processed.

Order-No.	Typ	○	●	↔	↔
33259	160	2.5	1.6	155	5

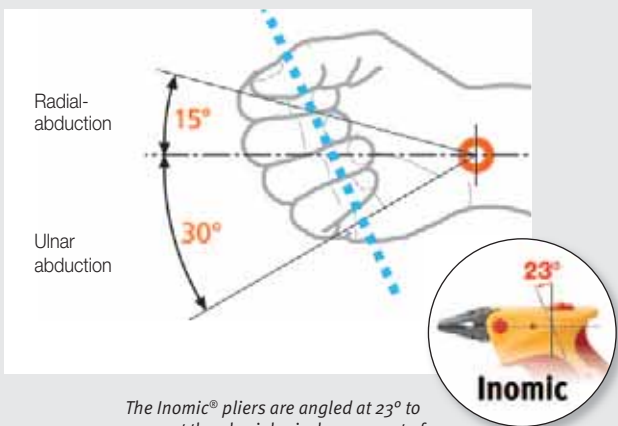

The Inomic® pliers are angled at 23° to support the physiological movement of the wrist when working and thus prevent an unhealthy wrist position, which often leads to problems such as carpal tunnel syndrome.

**Details of cutting results of cutting pliers.**

Symbol/Types of wire	Example	Tensile strength ca. N/mm <sup>2</sup>
○ Soft wire	Copper, aluminium	220 - 250
● Medium hard wire	Iron nail	750 - 800
● Hard wire	Spring wire, steel nails	1.600 - 1.800
● Piano wire	Hardened spring steel	2.200 - 2.300

Test wires standardised in DIN ISO 5744



1000 V IEC 60900:2012

**Z 12 9 16** Diagonal cutters Inomic® VDE. Insulation up to 1,000 V AC, GS-mark.

- Standards: Manufactured acc. to IEC 60900:2012.
- Head shape: Innovative head with dual cutting function. Cutting edge with bevel near the joint, cutting edge without bevel in the front cutting area.
- Design: Cutting edges additionally induction hardened to approx. 62 HRC. Arms of the pliers move in parallel: +25% force transfer. Angled shape (23°) for fatigue-free work. With opening spring and locking mechanism.
- Material: Pliers head of high-quality tool steel. Handles made of tough fibre-glass reinforced plastic, ergonomic soft grip zone in the handle.
- Application: For cutting hard wires in the joint area. Flush, burr-free cutting of soft wires, cables and plastics in the front cutting area. With improved access to the objects to be processed.

Order-No.	Typ	○	●	↔	↔
30666	160	3.5	2.5	1.6	145

# Wiha Professional.

Quality down to the last detail.



product  
design  
award

2011



Focus Energy  
Silver 2006



Functionality, quality and comfort: only three of the many features that professionals fundamentally demand of their tools. Wiha Professional implements these in a consistent manner.

With a new dimension in terms of functionality: DynamicJoint®, the progressive development of the joint construction, ensures precise cuts with simultaneously less force of power. Cutting performance is still as high even after thousands of applications! And in addition Wiha Professional pliers are characterised by manufacture from selected, multi-hardened steel with quality chrome plating. The elastic, shock absorbing plastic handles guarantee comfortable, fatigue-free work.

Wiha Professional carries on where average tools give up the ghost. For thoroughly professional results every time.



## Wiha Info



**Wiha DynamicJoint –**  
A new dimension in  
strength and durability

- **Innovative:**  
Optimised joint construction
- **Effective:**  
Low loss of force means less force needed for cutting
- **Permanent:**  
Optimal performance even after thousands of cuts

## Wiha Info

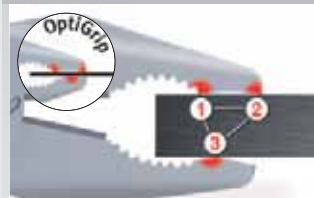

**Opti-Grip – optimal grip**  
due to newly designed gripping  
surfaces

- **A firm hold:** The 'triple-point support' protects the workpiece from twisting or slipping.
- **Highly effective:** Optimum grip even with a large jaw opening – and at the same time significantly less force needed
- **A wide selection:** Now in standard Wiha combination pliers and high leverage combination pliers



## Wiha Professional.

- **Powerful**  
With DynamicJoint, the high quality joint construction for simple, long-term cutting efficiency
- **As hard as steel**  
Pliers head drop forged from high quality steels
- **Robust and durable**  
Cutting edges are individually tempered and additionally induction hardened to approx. 64 HRC; joints are extremely wear resistant and withstand high stresses, with high-quality riveting
- **Ergonomic**  
Extra wide handle backs, with soft and hard zones perfectly distributed across the handle
- **Attractive**  
Award-winning design with high quality chrome-plated head



**Safety note:**  
When working with cutting pliers – beware of wire ends flying away. Please wear safety glasses.

**Combination and high leverage combination pliers.**



**Z 01 0 05** Combination pliers Professional.

Standards: DIN ISO 5746.  
Head shape: Extra long cutting edge for flat and round cables.  
Design: OptiGrip - the newly designed gripping surface with 'triple-point support' ensures optimal hold of the workpiece while working. Cutting edges additionally induction hardened to approx. 64 HRC. The Wiha DynamicJoint® ensures optimal transmission of hand strength to the cutting edges.  
Material: High quality C 70 tool steel, tempered.  
Application: General purpose pliers for gripping and holding as well as cutting soft and hard wires and cables.

Order-No.	mm	II	○	●	●	g	SB	≡
26704	160	6 ½	3.1	2.0	1.6	195		5
27327	160	6 ½	3.1	2.0	1.6	195	x	5
26707	180	7	3.4	2.2	1.8	245		5
27399	180	7	3.4	2.2	1.8	245	x	5
26710	200	8	3.8	2.5	2.0	325		5
27400	200	8	3.8	2.5	2.0	325	x	5



**Z 02 0 05** High leverage combination pliers Professional.

Standards: DIN ISO 5746.  
Head shape: Extra long cutting edge for flat and round cables.  
Design: OptiGrip - the newly designed gripping surface with 'triple-point support' ensures optimal hold of the workpiece while working. Particularly powerful leverage results in 40% less effort being required for cutting tasks compared with standard combination pliers. Cutting edges additionally inductively hardened to approx. 64 HRC, therefore also appropriate for cutting piano wire. The Wiha DynamicJoint® ensures optimal transmission of hand strength to the cutting edges.  
Material: High quality C 70 tool steel, specially tempered.  
Application: Power assisted general purpose pliers for gripping and holding as well as cutting wires and cables ranging in hardness from soft to extremely hard.

Order-No.	mm	II	○	●	●	g	SB	≡
26713	200	8	3.8	2.8	2.3	315		5
27401	200	8	3.8	2.8	2.3	315	x	5
26716	225	9	4.4	3.0	2.5	390		5
27402	225	9	4.4	3.0	2.5	390	x	5

**Needle nose pliers with cutting edge (snipe nose pliers).**



**Z 05 0 05** Needle nose pliers Professional with cutting edge.

Standards: DIN ISO 5745.  
Head shape: Straight shape.  
Design: Extra long cutting edge for flat and round cables. Gripping surfaces partially serrated in parts. Cutting edges additionally induction hardened to approx. 64 HRC.  
Material: High quality C 70 tool steel, tempered.  
Application: Gripping and holding as well as cutting soft and hard wires and cables. Preferred choice in the mechanical sector.

Order-No.	mm	II	○	●	●	g	SB	≡
26719	160	6 ½	2.5	1.8	1.2	155		5
27403	160	6 ½	2.5	1.8	1.2	155	x	5
26722	200	8	3.2	2.2	1.6	200		5
27404	200	8	3.2	2.2	1.6	200	x	5



**Z 05 1 05** Needle nose pliers Professional with cutting edge.

Standards: DIN ISO 5745.  
Head shape: Angled, approx. 40°.  
Design: Extra long cutting edge for flat and round cables. Gripping surfaces partially serrated in parts. Cutting edges additionally induction hardened to approx. 64 HRC.  
Material: High quality C 70 tool steel, tempered.  
Application: Gripping and holding as well as cutting soft and hard wires and cables. Preferred choice in the mechanical sector.

Order-No.	mm	II	○	●	●	g	SB	≡
26724	160	6 ½	2.5	1.8	1.2	155		5
27405	160	6 ½	2.5	1.8	1.2	155	x	5
26726	200	8	3.2	2.2	1.6	200		5
27406	200	8	3.2	2.2	1.6	200	x	5

**Details of cutting results of cutting pliers.**

Symbol/Types of wire	Example	Tensile strength ca. N/mm2
○ Soft wire	Copper, aluminium	220 - 250
○ Medium hard wire	Iron nail	750 - 800
● Hard wire	Spring wire, steel nails	1.600 - 1.800
● Piano wire	Hardened spring steel	2.200 - 2.300

Test wires standardised in DIN ISO 5744

# Wiha Professional.

Quality down to the last detail.

## Diagonal cutters and heavy duty diagonal cutters.



### Z 12 0 05 Diagonal cutters Professional.

Standards: DIN ISO 5749.  
 Head shape: Semi-circular, swedish style.  
 Design: Low wear lap joint, riveted and able to withstand high loads. The Wiha DynamicJoint® ensures optimal transmission of hand strength to the cutting edges. Lightweight action, clean cutting achieved by specially milled precision cutting edges. Long term cutting is achieved through additional inductive hardening to approx. 64 HRC.  
 Material: High quality C 70 tool steel, tempered.  
 Application: For soft and hard wires.

Order-No.	mm	II	○	●	●	●	g	SB	≡
26736	140	5 ½	4.0	2.5	1.8	1.4	160		5
27409	140	5 ½	4.0	2.5	1.8	1.4	160	x	5
26740	160	6 ½	4.0	2.8	2.0	1.6	200		5
27507	160	6 ½	4.0	2.8	2.0	1.6	200	x	5
26743	180	7	4.0	3.0	2.5	1.8	250		5
27410	180	7	4.0	3.0	2.5	1.8	250	x	5



### Z 16 0 05 Heavy duty diagonal cutters Professional.

Standards: DIN ISO 5749.  
 Head shape: Semi-circular.  
 Design: Low wear lap joint, riveted and able to withstand high levels of load. The Wiha DynamicJoint® ensures optimal transmission of hand strength to the cutting edges. Lightweight action, clean cutting achieved by specially milled precision cutting edges. Long term cutting is achieved through additional inductive hardening to approx. 64 HRC.  
 Material: High quality C 70 tool steel, specially tempered.  
 Application: Power assisted, all round diagonal cutter for soft wire as well as the most stringent of demands made by piano wires.

Order-No.	mm	II	○	●	●	g	SB	≡
26747	160	6 ½	3.5	2.5	2.0	190		5
27411	160	6 ½	3.5	2.5	2.0	190	x	5
26750	180	7	3.8	2.7	2.3	260		5
27412	180	7	3.8	2.7	2.3	260	x	5
26753	200	8	4.2	3.0	2.5	315		5
27413	200	8	4.2	3.0	2.5	315	x	5

## Diagonal cutters and stripping pliers.



NEW

### Z 18 0 05 BiCut Professional - switchable high-performance diagonal cutters.

Standards: Based on DIN ISO 5749.  
 Head shape: Semi-circular.  
 Design: Clever - BiCut does the job of two pairs of pliers. Powerful - Up to 50% less hand strength required for cutting. Power - Cutting force doubled for extremely hard materials. Comfortable - Easily switch between the two strengths in a one handed operation. Robust and durable - Cutter blades induction hardened up to 64 HRC.  
 Material: Hard as steel - Drop forged of high-quality C70 steel.  
 Application: For cutting various materials from soft to extremely hard, such as cables, nails, screws, bolts, wire cable, spring wire, chains, etc.

Order-No.	mm	II	○	●	g	SB	≡
38190	200	8	3.5	3	350		5
38983	200	8	3.5	3	350	x	5



### Z 55 0 05 Stripping pliers Professional.

Standards: DIN ISO 5743.  
 Head shape: Precision cutting edge prism for even cutting of cable insulation.  
 Design: An easy to use adjusting screw allows the stripping diameter to be set. Opening spring for effortless and sensitive handling of pliers.  
 Material: High quality C 70 tool steel, tempered.  
 Application: Simple stripping of cables and strands of up to ø 5 mm/ 10 mm² conductor cross-section.

Order-No.	mm	II	Ø	mm²	g	SB	≡
26846	160	6 ½	5	10	155		5
27417	160	6 ½	5	10	155	x	5

### Details of cutting results of cutting pliers.

Symbol/Types of wire	Example	Tensile strength ca. N/mm2
○ Soft wire	Copper, aluminium	220 - 250
○ Medium hard wire	Iron nail	750 - 800
● Hard wire	Spring wire, steel nails	1.600 - 1.800
● Piano wire	Hardened spring steel	2.200 - 2.300

Test wires standardised in DIN ISO 5744



**Safety note:**

When working with cutting pliers –  
beware of wire ends flying away.  
Please wear safety glasses.

**Water pump pliers.****Z 21 0 05** Water pump pliers Professional, box type.

Standards: DIN ISO 8976.

Head shape: Narrow head, therefore also appropriate for work in small spaces.

Design: Precision adjustment joint, box type, providing optimum adaptation to object to be gripped.

Long durability achieved by additional inductive hardening of gripper jaws.

Material: High quality chrome-vanadium molybdenum steel, tempered.

Application: For gripping and holding pipes and angular profiles such as hex nuts in the installation area.

Order-No.	mm	II	⊙	⊙	g	SB	
26762	250	10	2	50	380		5
27414	250	10	2	50	380	x	5

**Water pump pliers.****NEW****Z 23 1 05** QuickFix professional automatic water pump pliers, box type.

Standards: DIN ISO 8976.

Head shape: Narrow head, therefore also appropriate for work in small spaces.

Design: Fast and easy-to-adjust water pump pliers, with automatic adjustment of the box type, precision-stepped joint. Optimum adjustment to the object to be gripped. Long durability achieved by additional inductive hardening of gripper jaws.

Material: High quality chrome-vanadium molybdenum steel, tempered.

Application: For rapid and optimum gripping and holding of pipes and angular profiles such as hex nuts in the installation area.

Order-No.	mm	II	⊙	⊙	g	SB	
39093	250	10	1 ½	40	360		5
39095	250	10	1 ½	40	360	x	5

Available from September 2014

**Z 22 0 05** Water pump pliers Professional with push button setting.

Standards: DIN ISO 8976.

Head shape: Extra narrow head, therefore also appropriate for work in difficult to access areas.

Design: Precision adjustment joint, box type, providing optimum adaptation to object to be gripped.

Rapid and simple push button setting and locking.

Long durability achieved by additional inductive hardening of gripper jaws.

Material: High quality chrome-vanadium molybdenum steel, tempered.

Application: For gripping and holding pipes and angular profiles such as hex nuts in the installation area.

Order-No.	mm	II	⊙	⊙	g	SB	
26766	250	10	2	50	400		5
27415	250	10	2	50	400	x	5

**Opening width of water pump pliers.**

⊙: Maximum gripper width across flats [mm]

⊙: Maximum gripper pipe diameter [°]

**Wiha Info**

**Wiha BiCut -**  
Double the power at the  
press of a button

- **Clever:**  
BiCut does the job of two pairs of pliers.
- **Power:**  
Cutting force doubled for extremely hard materials.
- **Powerful:**  
Up to 50% less hand strength required for cutting.

**Wiha Info**

**Wiha DynamicJoint -**  
A new dimension in  
strength and durability

- **Innovative:**  
Optimised joint construction
- **Effective:**  
Low loss of force means less force needed for cutting
- **Permanent:**  
Optimal performance even after thousands of cuts



# Wiha Professional.

Quality down to the last detail.

## Needle-nose and round-nose pliers.



### Z 07 0 05 Long-flat nose pliers Professional.

Standards: DIN ISO 5745.  
 Head shape: Extra long head.  
 Design: Ridged gripping surfaces.  
 Material: High-quality tool steel, tempered.  
 Application: Gripping and right-angled bending of wires and sheet metal parts.

Order-No.	mm	II	g	SB	
26731	160	6 ½	160		5
27407	160	6 ½	160	x	5



### Z 09 0 05 Long-round nose pliers Professional.

Standards: DIN ISO 5745.  
 Head shape: Extra long head.  
 Design: Ridged gripping surfaces.  
 Material: High-quality tool steel, tempered.  
 Application: Gripping and bending of wires and sheet metal parts.

Order-No.	mm	II	g	SB	
26734	160	6 ½	140		5
27408	160	6 ½	140	x	5

## Revolving punch pliers.

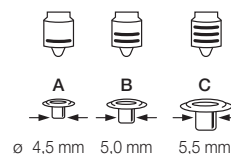
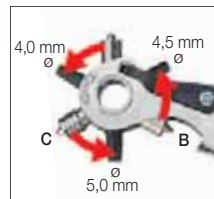

### Z 65 2 05 Professional revolving punch and loop pliers.

Head shape: Alternate equipping of perforating tubes and loop punches.  
 Design: Locking lever and rotatable magazine with hole sizes 4.0 / 4.5 and 5.0 mm and corresponding loop punches for loops of 4.5 / 5.0 / 5.5 mm sizes.  
 Ergonomic plastic handle.  
 Material: Body of pliers made of high-resistance special steel, nickel-plated.  
 Application: For perforating and pressing of loops in three sizes with only one tool.

Order-No.	mm	II	Ø	g	
29550	225	9	4,0-5,0	325	5



### Z 65 0 05 Professional revolving punch pliers.

Head shape: Size designation of perforating tubes in viewing window.  
 Design: Locking mechanism and 6 exchangeable punching tools, diameter: 2.0 / 2.5 / 3.0 / 3.5 / 4.0 / 4.5 mm.  
 With opening spring and locking mechanism for real single-handed operation.  
 Material: Body of pliers made of high-resistance special steel, nickel-plated.  
 Application: Perforation of a wide variety of different materials in trade, industry and DIY.

Order-No.	mm	II	Ø	g	
28402	225	9	2,0-4,5	325	5

**Safety note:**

When working with cutting pliers – beware of wire ends flying away. Please wear safety glasses.

**Pliers set.****Z 99 0 002 05 Pliers set Professional Plus, 3 pcs.**

**Design:** All pliers made of high quality tool steel, hardened, polished and chrome-plated.  
Multi-component handles with slip guard for safe and comfortable operation.  
Cutting pliers are also suited for extremely hard wires.  
QuickFix water pump pliers with "automatic" rapid adjustment.  
Weight 1120 g.

**Application:** Power assisted pliers for providing craftsmen or industrial mechanics with a basic set of pliers.

Order-No.	Series	
26854	Z 99 0 002 05	1
	Z 02 0 05	High leverage combination pliers, with Wiha DynamicJoint and OptiGrip 200 mm 7"
	Z 16 0 05	High leverage diagonal cutters, with Wiha DynamicJoint 180 mm 7"
	Z 23 1 05	QuickFix water pump pliers, 250 mm 10"

**Display.****Z 99 0 005 05VH Professional pliers display.**

**Carton display with 10 pliers and 10 pliers flyers.**

**Design:** Pliers made of high quality tool steel, hardened, polished and chrome plated.  
Multi-component handles with slip guard for safe and comfortable operation.  
Size 33.5 x 20 x 40 cm (WxDxH).  
Weight 6.95 kg.

**Application:** The pliers selection for demanding users in trade and industry.

Order-No.	Series	
36066	Z 99 0 005 05VH	1
	Z 01 0 05	Combination pliers Professional. With Wiha DynamicJoint® and OptiGrip. 180 mm 7"
	Z 02 0 05	Professional high-leverage combination pliers, 200 mm With Wiha DynamicJoint® and OptiGrip. 200 mm 8"
	Z 05 0 05	Needle nose pliers, 160 mm 160 mm 6 1/2"
	Z 12 0 05	Diagonal cutters Professional. With Wiha DynamicJoint®. 160 mm 6 1/2"
	Z 16 0 05	Professional heavy-duty diagonal cutters, 180 mm With Wiha DynamicJoint®. 180 mm 7"

**Wiha Info****Wiha DynamicJoint – A new dimension in strength and durability**

- **Innovative:** Optimised joint construction
- **Effective:** Low loss of force means less force needed for cutting
- **Permanent:** Optimal performance even after thousands of cuts

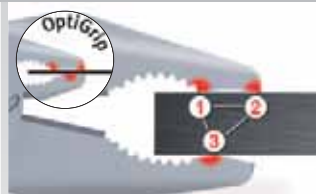
**Wiha Info****Opti-Grip – optimal grip due to newly designed gripping surfaces**

- **A firm hold:** The 'triple-point support' protects the workpiece from twisting or slipping.
- **Highly effective:** Optimum grip even with a large jaw opening – and at the same time significantly less force needed
- **A wide selection:** Now in standard Wiha combination pliers and high leverage combination pliers

# Wiha Professional electric.

Completely reliable.



product  
design  
award

2011



Focus Energy  
Silver 2006

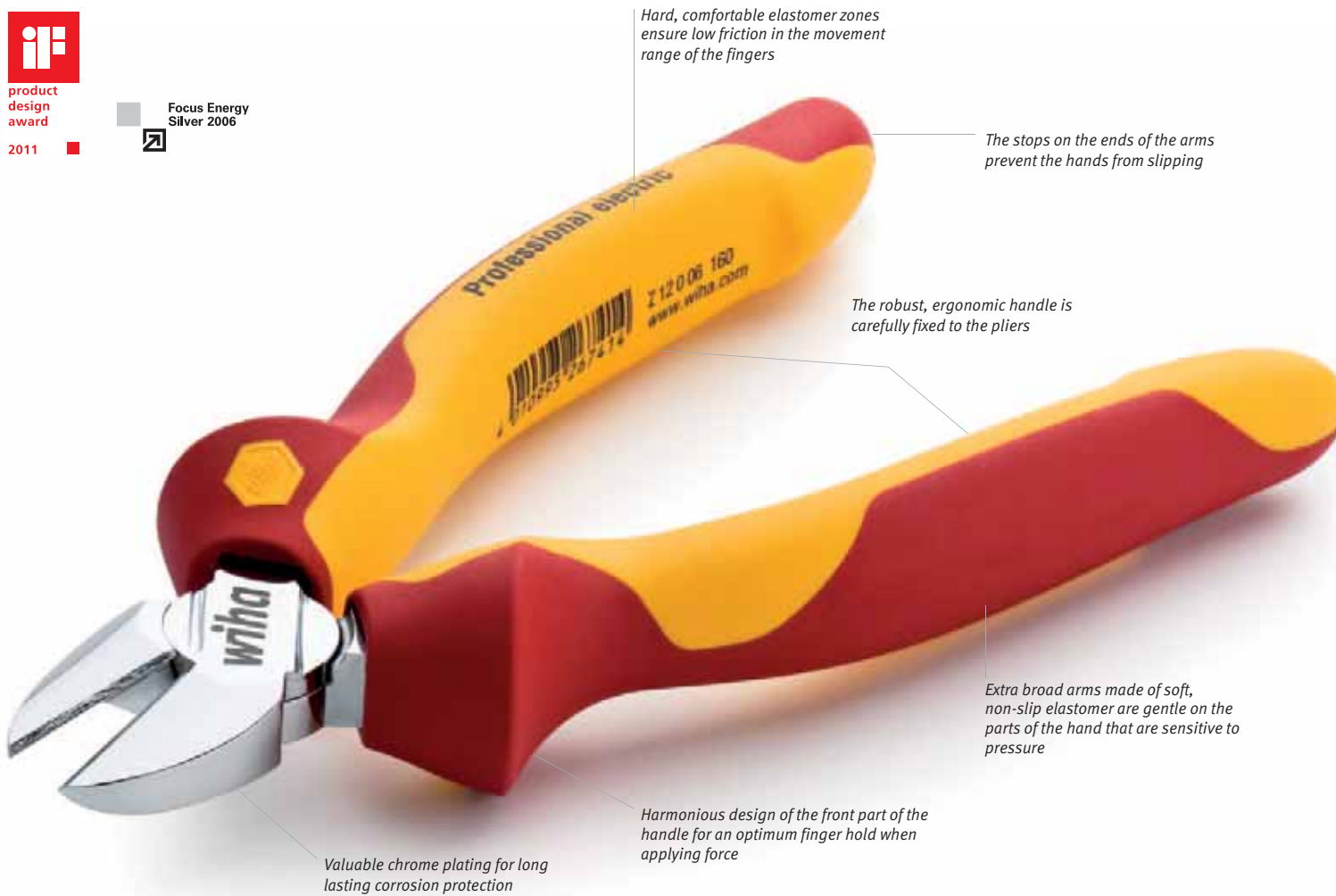

Hard, comfortable elastomer zones ensure low friction in the movement range of the fingers

The stops on the ends of the arms prevent the hands from slipping

The robust, ergonomic handle is carefully fixed to the pliers

Extra broad arms made of soft, non-slip elastomer are gentle on the parts of the hand that are sensitive to pressure

Harmonious design of the front part of the handle for an optimum finger hold when applying force

Valuable chrome plating for long lasting corrosion protection

For the VDE-tested Wiha Professional electric pliers only one thing counts: to protect the user one hundred percent when working precisely with live parts.

The new DynamicJoint® construction proves its worth: it makes cutting significantly easier and helps to eliminate the danger of cramping or slipping due to excessive force of power.

In addition the handle insulation and curved handle ends that prevent the fingers slipping away ensure even more safety.



## Wiha Info



Wiha DynamicJoint – A new dimension in strength and durability

- **Innovative:**  
Optimised joint construction
- **Effective:**  
Low loss of force means less force needed for cutting
- **Permanent:**  
Optimal performance even after thousands of cuts

Must maintain the highest level of electrical safety! All Wiha Professional electric pliers meet the strict VDE requirements.



Approved for work in the area of live parts up to 1,000 V AC or 1,500 V DC. When working with VDE tools, observe the national safety and accident prevention regulations.



## Wiha Professional electric.

- **Uncompromisingly safe**  
Manufactured and inspected according to IEC 60900:2012, one-off testing at 10,000 V, GS mark for inspected safety, VDE tested
- **Powerful**  
With DynamicJoint®, the high quality joint construction for simple, long-term cutting efficiency
- **As hard as steel**  
Pliers head drop forged from high quality steels
- **Robust and durable**  
Cutting edges are individually tempered and additionally induction hardened, joints are extremely wear resistant and can withstand high stresses, and with high-quality riveting
- **Ergonomic**  
Extra wide handle backs, with soft and hard zones perfectly distributed across the handle
- **Attractive**  
Award-winning design

**Safety note:**

When working with cutting pliers –  
beware of wire ends flying away.  
Please wear safety glasses.

**Combination pliers and high-leverage combination pliers.**

1000 V  
IEC 60900:2012

**Z 01 0 06**

**Combination pliers Professional electric.**  
Individually tested protective insulation 1,000 V AC, VDE and GS tested.

Standards: DIN ISO 5746. Manufactured acc. to IEC 60900:2012.

Head shape: Extra long cutting edge for flat and round cables.

Design: OptiGrip - the newly designed gripping surface with 'triple-point support' ensures optimal hold of the workpiece while working.  
Cutting edges additionally induction hardened to approx. 64 HRC.  
The Wiha DynamicJoint® ensures optimal transmission of hand strength to the cutting edges.

Material: High quality C 70 tool steel, tempered.

Application: General purpose pliers for gripping and holding as well as cutting soft and hard wires and cables.

For all work on or around electrical components up to 1,000 V AC.

Order-No.	mm	II	○	●	●	g	SB	SB
26705	160	6 ½	3.1	2.0	1.6	195		5
27328	160	6 ½	3.1	2.0	1.6	195	x	5
26708	180	7	3.4	2.2	1.8	245		5
27418	180	7	3.4	2.2	1.8	245	x	5
26711	200	8	3.8	2.5	2.0	325		5
27419	200	8	3.8	2.5	2.0	325	x	5



1000 V  
IEC 60900:2012

**Z 02 0 06**

**High leverage combination pliers Professional electric.**  
Individually tested protective insulation 1,000 V AC, VDE and GS tested.

Standards: DIN ISO 5746. Manufactured acc. to IEC 60900:2012.

Head shape: Extra long cutting edge for flat and round cables.

Design: OptiGrip - the newly designed gripping surface with 'triple-point support' ensures optimal hold of the workpiece while working.

Particularly powerful leverage results in 40% less effort being required for cutting tasks compared with standard combination pliers.

Cutting edges additionally inductively hardened to approx. 64 HRC, therefore also appropriate for cutting piano wire.

The Wiha DynamicJoint® ensures optimal transmission of hand strength to the cutting edges.

Material: High quality C 70 tool steel, specially tempered.

Application: Power assisted general purpose pliers for gripping and holding as well as cutting wires and cables ranging in hardness from soft to extremely hard. For all work on or around electrical components up to 1,000 V AC.

Order-No.	mm	II	○	●	●	g	SB	SB
26714	200	8	3.8	2.8	2.3	330		5
27420	200	8	3.8	2.8	2.3	330	x	5
26717	225	9	4.4	3.0	2.5	390		5
27421	225	9	4.4	3.0	2.5	390	x	5

**Needle nose pliers with cutting edge (snipe nose pliers).**

1000 V  
IEC 60900:2012

**Z 05 0 06**

**Needle nose pliers Professional electric with cutting edge.**  
Individually tested protective insulation 1,000 V AC, VDE and GS tested.

Standards: DIN ISO 5745. Manufactured acc. to IEC 60900:2012.

Head shape: Straight shape.

Design: Extra long cutting edge for flat and round cables.

Gripping surfaces partially serrated in parts.

Cutting edges additionally induction hardened to approx. 64 HRC.

Material: High quality C 70 tool steel, tempered.

Application: Gripping and holding as well as cutting soft and hard wires and cables. Preferred choice in the electrical sectors.

For all work on or around electrical components up to 1,000 V AC.

Order-No.	mm	II	○	●	●	g	SB	SB
26720	160	6 ½	2.5	1.8	1.2	155		5
27422	160	6 ½	2.5	1.8	1.2	155	x	5
26727	200	8	3.2	2.2	1.6	200		5
27423	200	8	3.2	2.2	1.6	200	x	5



1000 V  
IEC 60900:2012

**Z 05 1 06**

**Needle nose pliers Professional electric with cutting edge.**  
Individually tested protective insulation 1,000 V AC, VDE and GS tested.

Standards: DIN ISO 5745. Manufactured acc. to IEC 60900:2012.

Head shape: Angled, approx. 40°.

Design: Extra long cutting edge for flat and round cables.

Gripping surfaces partially serrated in parts.

Cutting edges additionally induction hardened to approx. 64 HRC.

Material: High quality C 70 tool steel, tempered.

Application: Gripping and holding as well as cutting soft and hard wires and cables. Preferred choice in the electrical sectors.

For all work on or around electrical components up to 1,000 V AC.

Order-No.	mm	II	○	●	●	g	SB	SB
26728	160	6 ½	2.5	1.8	1.2	155		5
27424	160	6 ½	2.5	1.8	1.2	155	x	5
26729	200	8	3.2	2.2	1.6	200		5
27425	200	8	3.2	2.2	1.6	200	x	5

**Details of cutting results of cutting pliers.**

Symbol/Types of wire	Example	Tensile strength ca. N/mm <sup>2</sup>
○ Soft wire	Copper, aluminium	220 - 250
● Medium hard wire	Iron nail	750 - 800
● Hard wire	Spring wire, steel nails	1.600 - 1.800
● Piano wire	Hardened spring steel	2.200 - 2.300

Test wires standardised in DIN ISO 5744



# Wiha Professional electric.

Completely reliable.

## Diagonal cutters.



**Z 12 0 06**

**Diagonal cutters Professional electric.**  
Individually tested protective insulation 1,000 V AC, VDE and GS tested.

Standards: DIN ISO 5749.  
Manufactured acc. to IEC 60900:2012.  
Head shape: Semi-circular, swedish style.  
Design: Low wear lap joint, riveted and able to withstand high loads. Lightweight action, clean cutting achieved by specially milled precision cutting edges. Long term cutting is achieved through additional inductive hardening to approx. 64 HRC. The Wiha DynamicJoint® ensures optimal transmission of hand strength to the cutting edges.  
Material: High quality C 70 tool steel, tempered.  
Application: Universal cutter for cutting soft and hard wires and cables, also suitable for cutting and stripping cables. For all work on or around electrical components up to 1,000 V AC.

Order-No.	mm	II	○	●	●	●	g	SB	≡
26737	140	5 ½	4.0	2.5	1.8	1.4	160		5
27428	140	5 ½	4.0	2.5	1.8	1.4	160	x	5
26741	160	6 ½	4.0	2.8	2.0	1.6	200		5
27429	160	6 ½	4.0	2.8	2.0	1.6	200	x	5
26744	180	7	4.0	3.0	2.5	1.8	250		5
27430	180	7	4.0	3.0	2.5	1.8	250	x	5



**Z 16 0 06**

**Heavy duty diagonal cutters Professional electric.**  
Individually tested protective insulation 1,000 V AC, VDE and GS tested.

Standards: DIN ISO 5749.  
Manufactured acc. to IEC 60900:2012.  
Head shape: Semi-circular.  
Design: Low wear lap joint, riveted and able to withstand high levels of load. Lightweight action, clean cutting achieved by specially milled precision cutting edges. Long term cutting is achieved through additional inductive hardening to approx. 64 HRC. The Wiha DynamicJoint® ensures optimal transmission of hand strength to the cutting edges.  
Material: High quality C 70 tool steel, tempered.  
Application: Power-assisted all-round diagonal cutter for cutting soft to extremely hard wires and cables. For all work on or around electrical components up to 1,000 V AC.

Order-No.	mm	II	○	●	●	g	SB	≡
26748	160	6 ½	3.5	2.5	2.0	190		5
27432	160	6 ½	3.5	2.5	2.0	190	x	5
26751	180	7	3.8	2.7	2.3	260		5
27434	180	7	3.8	2.7	2.3	260	x	5
26754	200	8	4.2	3.0	2.5	315		5
27435	200	8	4.2	3.0	2.5	315	x	5

## Diagonal cutters.



**NEW**

**Z 18 0 06**

**BiCut Professional electric - switchable high-performance diagonal cutters.**  
Individually tested protective insulation 1,000 V AC, VDE and GS tested.

Standards: Based on DIN ISO 5749.  
Head shape: Semi-circular.  
Design: Clever - BiCut does the job of two pairs of pliers. Powerful - Up to 50% less hand strength required for cutting. Power - Cutting force doubled for extremely hard materials. Comfortable - Easily switch between the two strengths in a one handed operation. Robust and durable - Cutter blades induction hardened up to 64 HRC.  
Material: Hard as steel - Drop forged of high-quality C70 steel.  
Application: For cutting various materials from soft to extremely hard, such as cables, nails, screws, bolts, wire cable, spring wire, chains, etc. For all work on or around electrical components up to 1,000 V AC.

Order-No.	mm	II	○	●	g	SB	≡
38191	200	8	3.5	3	350		5
38984	200	8	3.5	3	350	x	5



**Z 14 0 06**

**Electrician's diagonal cutters Professional electric.**  
Individually tested protective insulation 1,000 V AC, VDE and GS tested.

Standards: DIN ISO 5749.  
Manufactured acc. to IEC 60900:2012.  
Head shape: Semi-circular, swedish style.  
Design: Low wear lap joint, riveted and able to withstand high loads. The Wiha DynamicJoint® ensures optimal transmission of hand strength to the cutting edges. Lightweight action, clean cutting achieved by specially milled precision cutting edges. Long term cutting is achieved through additional inductive hardening to approx. 64 HRC. Rear cutting area near to plier joint also suitable for medium-hard and hard wire. Front cutting area for soft wire, with precision stripping stations for 1.5 mm² and 2.5 mm² single-wire conductor.  
Material: High quality C 70 tool steel, tempered.  
Application: Special diagonal cutters with additional function for electrical installation. For all work on or around electrical components up to 1,000 V AC.

Order-No.	mm	II	○	●	g	SB	≡
26745	160	6 ½	4.0	2.0	1.6	200	5
27431	160	6 ½	4.0	2.0	1.6	200	x 5





**Safety note:**  
When working with cutting pliers – beware of wire ends flying away. Please wear safety glasses.

**Installation pliers and cable cutter.**



**NEW**  
**Z 14 1 06** Professional electric TriCut installation pliers  
Individually tested protective insulation 1,000 V AC, VDE and GS tested.

Standards: Manufactured acc. to IEC 60900:2012.  
Head shape: With three processing stations: For cutting and stripping.  
Design: Low wear lap joint, riveted and able to withstand high loads. Diagonal cutters with durable cutting edges due to additional induction hardening to approx. 64 HRC. Ergonomic and energy-saving stripping lengthwise on the cable and the pliers, thanks to the specially cranked head.  
Material: High quality C 70 tool steel, tempered.  
Application: Diagonal cutters for cutting soft and hard wires, as well as cables such as NYM lines 3x1.52 - 5x2.52  
Flush stripping of round and damp-proof cable and stripping of conductors, even in hard-to-reach areas, e.g. in junction boxes and distribution boxes. For all work on or around electrical components up to 1,000 V AC.

Order-No.	mm	II	○	○	●	g	SB	▬
38552	170	7	4	2.5	1.6	260		5
38853	170	7	4	2.5	1.6	260	x	5



**Z 50 1 06** Cable cutters Professional electric.  
Individually tested protective insulation 1,000 V AC, VDE and GS tested.

Standards: Manufactured acc. to IEC 60900:2012.  
Head shape: Classic cutting form.  
Design: Light, energy-saving and clean cutting with specially ground precision cutting edges. Durable cutting edges due to additional induction hardening to approx. 58 HRC. Safety stop prevents finger injuries after cutting.  
Material: Special tool steel C 70, tempered.  
Application: Cable cutter for cutting of copper and aluminium cables without crushing, also suitable for stripping. Not for steel cable, wires and copper conductors with hard coatings. For all work on or around electrical components up to 1,000 V AC.

Order-No.	mm	II	∅	mm <sup>2</sup>	g	SB	▬
34743	160	6 ½	16	50	190		5
35704	160	6 ½	16	50	190	x	5
34744	200	8	20	60	305		5
35705	200	8	20	60	305	x	5

**Stripping pliers and needle-nose and round-nose pliers.**



**Z 55 0 06** Stripping pliers Professional electric.  
Individually tested protective insulation 1,000 V AC, VDE and GS tested.

Standards: DIN ISO 5743. Manufactured acc. to IEC 60900:2012.  
Head shape: Precision cutting edge prism for even cutting of cable insulation.  
Design: An easy to use adjusting screw allows the stripping diameter to be set. Opening spring for effortless and sensitive handling of pliers.  
Material: High quality C 70 tool steel, tempered.  
Application: Simple stripping of cables and strands of up to ø 5 mm/ 10 mm<sup>2</sup> conductor cross-section.  
For all work on or around electrical components up to 1,000 V AC.

Order-No.	mm	II	∅	mm <sup>2</sup>	g	SB	▬
26847	160	6 ½	5	10	155		5
27437	160	6 ½	5	10	155	x	5



**Z 07 0 06** Long-flat nose pliers Professional electric.  
Individually tested protective insulation 1,000 V AC, VDE and GS tested.

Standards: DIN ISO 5745. Manufactured acc. to IEC 60900:2012.  
Head shape: Extra long head.  
Design: Ridged gripping surfaces.  
Material: High-quality tool steel, tempered.  
Application: Gripping and right-angled bending of wires and sheet metal parts.  
For all work on or around electrical components up to 1,000 V AC.

Order-No.	mm	II	g	SB	▬
26732	160	6 ½	160		5
27426	160	6 ½	160	x	5



**Z 09 0 06** Long-round nose pliers Professional electric.  
Individually tested protective insulation 1,000 V AC, VDE and GS tested.

Standards: DIN ISO 5745. Manufactured acc. to IEC 60900:2012.  
Head shape: Extra long head.  
Design: Ridged gripping surfaces.  
Material: High-quality tool steel, tempered.  
Application: Gripping and bending of wires and sheet metal parts.  
For all work on or around electrical components up to 1,000 V AC.

Order-No.	mm	II	g	SB	▬
26735	160	6 ½	140		5
27427	160	6 ½	140	x	5

# Wiha Professional electric.

Completely reliable.

## Water pump pliers.



**NEW** 1000 V IEC 60900:2012  
**Z 21 0 06**

**Professional electric water pump pliers, box type.**  
Individually tested protective insulation 1,000 V AC, VDE and GS tested.

- Standards: DIN ISO 8976.  
Manufactured acc. to IEC 60900:2012.
- Head shape: Narrow head, therefore also appropriate for work in small spaces.
- Design: Precision adjustment joint, box type, providing optimum adaptation to object to be gripped. Long durability achieved by additional inductive hardening of gripper jaws.
- Material: Chrome-vanadium molybdenum steel, tempered.
- Application: For gripping and holding pipes and angular profiles such as hex nuts in the installation area. For all work on or around electrical components up to 1,000 V AC.

Order-No.	mm	II	⊙	⊙	g	SB	
33520	250	10	2	50	405		5
38631	250	10	2	50	405	x	5



**NEW** 1000 V IEC 60900:2012  
**Z 22 0 06**

**Professional electric water pump pliers with push button adjustment.**  
Individually tested protective insulation 1,000 V AC, VDE and GS tested.

- Standards: DIN ISO 8976.  
Manufactured acc. to IEC 60900:2012.
- Head shape: Narrow head, therefore also appropriate for work in small spaces.
- Design: Precision adjustment joint, box type, providing optimum adaptation to object to be gripped. Rapid and simple push button setting and locking. Long durability achieved by additional inductive hardening of gripper jaws.
- Material: Chrome-vanadium molybdenum steel, tempered.
- Application: For gripping and holding pipes and angular profiles such as hex nuts in the installation area.  
For all work on or around electrical components up to 1,000 V AC.

Order-No.	mm	II	⊙	⊙	g	SB	
37450	250	10	2	50	405		5
38632	250	10	2	50	405	x	5

## Crimping pliers.



**NEW** 1000 V IEC 60900:2012  
**Z 60 0 06**

**Professional electric crimping pliers.**  
Individually tested protective insulation 1,000 V AC, VDE and GS tested.

- Standards: DIN ISO 5743.  
Manufactured acc. to IEC 60900:2012.
- Head shape: Fixed profile grooves for the relevant conductor cross-sections.
- Design: Trapezoidal or semi-circular profiles for a secure connection between end sleeve and conductor. Sleeve and conductor inserted from the side.
- Material: High-quality tool steel, tempered.
- Application: For crimping end sleeves acc. to DIN 46228 parts 1 + 4.  
For all work on or around electrical components up to 1,000 V AC.

Order-No.	mm	II	mm <sup>2</sup>	g	SB	
35861	145	5 ¼	0,25-2,5	130		5
38985	145	5 ¼	0,25-2,5	250	x	5
35862	180	7	0,25-16	250		5
38986	180	7	0,25-16	250	x	5

### Opening width of water pump pliers.

- ⊙: Maximum gripper width across flats [mm]  
⊙: Maximum gripper pipe diameter [ " ]

**Safety note:**

When working with cutting pliers – beware of wire ends flying away. Please wear safety glasses.

**Pliers set.**

**Z 99 0 001 06** Pliers set Professional electric, 3 pcs.  
Individually tested protective insulation 1,000 V AC, VDE and GS tested.

**Design:** All pliers made of high quality tool steel, hardened, polished and chrome-plated. Multi-component handles with slip guard for safe and comfortable operation. Individually tested for electrical safety in accordance with IEC 60900:2012. Weight 820 g.

**Application:** All tools suitable for use with or near live components up to 1,000 V AC. For all work on or around electrical components up to 1,000 V AC.

Order-No.	Series	
26852	Z 99 0 001 06	1
	Z 01 0 06	Combination pliers Professional electric. With Wiha DynamicJoint® and OptiGrip. 180 mm 7"
	Z 12 0 06	Diagonal cutters Professional electric. With Wiha DynamicJoint®. 160 mm 6 1/2"
	Z 05 0 06	Needle nose pliers Professional electric with cutting edge. With Wiha DynamicJoint® and OptiGrip. 200 mm 8"

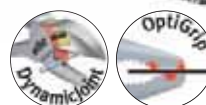
**Display.**

**NEU**  
**Z 99 0 005 06VH** Professional electric pliers display.  
Card display with 10 pieces.  
Insulation up to 1,000 V AC, GS-mark.

**Design:** Pliers made of high quality tool steel, hardened, polished and chrome plated. Multi-component handles with slip guard for safe and comfortable operation. Size 25.5 x 25.5 x 25.5 cm (WxDxH). Weight 3.18 kg.

**Application:** The pliers selection for demanding electricians. For all work on or around electrical components up to 1,000 V AC.

Order-No.	Series	
36063	Z 99 0 005 06VH	1
	Z 01 0 06	Combination pliers Professional electric. With Wiha DynamicJoint® and OptiGrip. 180 mm 7"
	Z 05 0 06	Needle nose pliers Professional electric with cutting edge. With Wiha DynamicJoint® and OptiGrip. 200 mm 8"
	Z 12 0 06	Diagonal cutters Professional electric. With Wiha DynamicJoint®. 160 mm 6 1/2"
	Z 16 0 06	Heavy duty diagonal cutters Professional electric. With Wiha DynamicJoint®. 180 mm 7"
	Z 55 0 06	Stripping pliers Professional electric. 160 mm 6 1/2"

**Wiha Info**

**Wiha DynamicJoint – A new dimension in strength and durability**

- **Innovative:** Optimised joint construction
- **Effective:** Low loss of force means less force needed for cutting
- **Permanent:** Optimal performance even after thousands of cuts

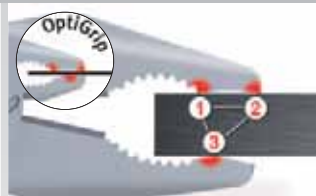
**Wiha Info**

**Opti-Grip – optimal grip due to newly designed gripping surfaces**

- **A firm hold:** The 'triple-point support' protects the workpiece from twisting or slipping.
- **Highly effective:** Optimum grip even with a large jaw opening – and at the same time significantly less force needed
- **A wide selection:** Now in standard Wiha combination pliers and high leverage combination pliers

# Wiha Professional electric.

Completely reliable.

## Cable shears.



### Z 71 1 06 Cable shears Professional electric.

Head shape: Lightweight standard model, straight.  
 Design: Standard model with wire stripper, cutting length 37 mm. Screw joint, adjustable cutting blades. Extruded plastic handle for a secure hold when cutting.  
 Material: C 50 carbon steel, hardened, nickel-plated.  
 Application: Universal cutter for electricians and other trades, also suitable for cutting and cutting back of cables.

Order-No.	mm	II	g	
27907	145	5 ¾	95	5

## Cable shears.



### Z 71 4 06 Electrician's / craftsman's cutters Professional electric.

Head shape: Sturdy model, straight, very robust, micro-toothed cutting.  
 Design: Precision model with wire stripper; cutting length 50 mm. Concealed, adjustable screw joint. Extruded handle made of impact-resistant plastic for powerful and safe cutting.  
 Material: High-alloy carbon steel, hardened, black finish.  
 Application: Highly-developed universal cutter for electricians and other trades, also suitable for cutting and stripping copper cables.

Order-No.	mm	II	g	
27910	145	5 ¾	120	manganese-phosphated 5



### Z 71 6 06 Electrician's / craftsman's cutters Professional electric.

Head shape: Strong, powerful design, straight, very robust, micro-ridged blade.  
 Design: Particularly comfortable two-component handle with soft zone in area subject to compressive stress. Cutting edge with wire cutter, cutting length 43 mm, cutting edge hardness approx. 56 HRC. Concealed, adjustable screw joint.  
 Material: Blades made of stainless steel, handles made of high-quality plastics.  
 Application: Qualitative, comfortable universal shears for electricians and many applications for trade and industry. Also suitable for cutting and cutting back of cables.

Order-No.	mm	II	g	
33910	145	5 ¾	80	5



### Z 71 5 06 Electrician's / craftsman's cutters Professional electric.

Head shape: Standard model, straight, micro-toothed blade.  
 Design: Particularly comfortable two-component handle with soft zone in area subject to compressive stress. Cutting edge with wire cutter, cutting length 34 mm. Concealed, adjustable screw joint.  
 Material: Blades made of stainless steel, handles made of high-quality plastics.  
 Application: Comfortable universal cutter for many applications in trade and industry, also suitable for cutting and stripping cables.

Order-No.	mm	II	g	
29420	145	5 ¾	60	5

# Wiha crimp tools.

## Crimping tools.



### Z 62 0 000 06 Crimping tools for wire-end sleeves.

Head shape: Square crimp, linear pressing.  
 Design: Tool with only one crimp profile.  
 Automatic adjustment of cross-section area.  
 Lateral contact feed.  
 Low hand force required with optimal transmission.  
 Delockable force lock for ensuring complete crimping process; required crimp pressure is factory set.  
 Ergonomically formed soft handle with slip protection for especially comfortable handling.  
 Material: Of high-tensile special steel.  
 Parts subject to extreme loading are specially hardened and tempered.  
 Application: For processing of wire-end sleeves with and without isolating collar according to DIN 46228, EN 50027. Especially suitable for processing twin sleeves.

Order-No.	mm	Ø mm	AWG	g	
33845	196	0.08-10	28-8	300	1



### Z 62 0 001 06 Crimping tools for wire-end sleeves.

Head shape: Trapezoid crimp, radial travel.  
 Design: Crimp profile:  
 Profile 1. 0.14 - 0.75 mm<sup>2</sup> / AWG 26 - 18  
 Profile 2. 1.0 - 1.5 mm<sup>2</sup> / AWG 18 - 16  
 Profile 3. 2.5 mm<sup>2</sup> / AWG 14  
 Profile 4. 4.0 mm<sup>2</sup> / AWG 12  
 Profile 5. 6.0 mm<sup>2</sup> / AWG 10  
 Profile 6. 10.0 mm<sup>2</sup> / AWG 8  
 Delockable force lock for ensuring complete crimping process; required crimp pressure is factory set.  
 Ergonomically formed soft handle with slip protection for especially comfortable handling.  
 Material: Of high-tensile special steel.  
 Parts subject to extreme loading are specially hardened and tempered.  
 Application: For processing of wire-end sleeves with and without isolating collar according to DIN 46228, EN 50027.

Order-No.	mm	Ø mm	AWG	g	
33844	220	0.14-10	26-8	510	1

## Crimping tools.



### Z 62 0 002 06 Crimping tools for isolated cable eyes and contacts.

Head shape: Oval crimp, radial pressing.  
 Conducting and isolating crimp are carried out in one work step.  
 Design: Crimp profile:  
 Red profile: 0.5 - 1.0 mm<sup>2</sup> / AWG 20 - 16  
 Blue profile: 1.5 - 2.5 mm<sup>2</sup> / AWG 16 - 14  
 Yellow profile: 4.0 - 6.0 mm<sup>2</sup> / AWG 12 - 10  
 Delockable force lock for ensuring complete crimping process; required crimp pressure is factory set. Ergonomically formed soft handle with slip protection for especially comfortable handling.  
 Material: Of high-tensile special steel.  
 Parts subject to extreme loading are specially hardened and tempered.  
 Application: For processing of red, blue and yellow isolated cable eyes, pin-end cable connectors, contact pins, contact pin sleeves, circular pins, circular pin sleeves, batch connectors and parallel connectors according to DIN 46234.  
 For standardised, solderless electrical connections.

Order-No.	mm	Ø mm	AWG	g	
33841	220	0.5-6	20-10	510	1



### Z 62 0 004 06 Crimping tools for non-isolated cable eyes with closed sleeve.

Head shape: W injection, radial pressing.  
 Design: Crimp profile:  
 Profile 1. 0.1 - 0.5 mm<sup>2</sup> / AWG 26 - 20  
 Profile 2. 0.5 - 2.5 mm<sup>2</sup> / AWG 20 - 14  
 Profile 3. 4.0 - 6.0 mm<sup>2</sup> / AWG 12 - 10  
 Profile 4. 10.0 - 16.0 mm<sup>2</sup> / AWG 8 - 6  
 Delockable force lock for ensuring complete crimping process; required crimp pressure is factory set.  
 Ergonomically formed soft handle with slip protection for especially comfortable handling.  
 Material: Of high-tensile special steel.  
 Parts subject to extreme loading are specially hardened and tempered.  
 Application: For processing of non-isolated cable eyes, pin-end cable connectors, batch connectors and mini cable eyes according to DIN 46230/ DIN 46341.  
 For solderless electrical connections according to standards.

Order-No.	mm	Ø mm	AWG	g	
33843	220	0.1-16	26-6	510	1



# Wiha crimp tools and stripping pliers.

## Crimping tools and automatic stripping pliers.



### Z 62 0 003 06 Crimping tools for non-isolated contact pins.

**Head shape:** B-crimp, radial pressing.  
 Conducting and isolating crimp are carried out in one work step.

**Design:**  
 Crimp profile: Contact width 6.3 / 9.5 mm  
 Profile 1. 0.25 - 0.5 mm<sup>2</sup> / AWG 22 - 20 / F 6.3 + 9.5  
 Profile 2. 0.5 - 1.0 mm<sup>2</sup> / AWG 20 - 16 / F 6.3 + 9.5  
 Profile 3. 1.5 - 2.5 mm<sup>2</sup> / AWG 16 - 14 / F 6.3 + 9.5  
 Profile 4. 4.0 - 6.0 mm<sup>2</sup> / AWG 12 - 10 / F 6.3 + 9.5  
 Delockable force lock for ensuring complete crimping process; required crimp pressure is factory set. Ergonomically formed soft handle with slip protection for especially comfortable handling.

**Material:** Of high-tensile special steel.  
 Parts subject to extreme loading are specially hardened and tempered.

**Application:** For processing of non-isolated contact pins and contact pin sleeves according to DIN 46247 for standardised, solderless electrical connections.

Order-No.	mm	Ø mm	AWG	g	SB
33842	220	0.25-6	22-10	510	1



### 246 75 SB Automatic stripping pliers. Blister packed.

**Design:** Automatic setting to various conductor diameters. Settable length stop from 5 - 12 mm, can be removed if required. Integrated, easily accessible wire cutter. Light, ergonomically designed tool body with narrow head for optimal use in hard-to-reach areas. Locking for safe, space-saving transport.

**Material:** Housing of glass-fibre reinforced polyamide.

**Application:** Stripping of all commonly used flexible and solid conductors from 0.2 - 6.0 mm<sup>2</sup> (24 - 10 AWG). Wire cutter for cutting of Cu and Al conductors to max. Ø2 mm.

Order-No.	mm	mm	Ø mm	AWG	g	SB
36050	190	7½	0.2-6.0	24-10	110	x 1

## Automatic Stripping pliers.



### 246 72 SB Automatic stripping pliers. Blister packed.

**Design:** Self-adjusting straight cutting edge in exchangeable cassette and wire cutter for copper and Al conductors. Optimally positioned wire cutter enables effortless cutting of multi-wire conductors to 10 mm<sup>2</sup> / 8 AWG. Simply replaceable stripping cassette with adjustable stripping length to 18 mm and adjustable cutting depth for various insulation materials. Ergonomically sophisticated solution with soft plastic zone in main handle, secure gripping without play, optimised handle opening width, an angled head as well as a low weight for working without fatigue.

**Material:** Housing of tough glass-fibre reinforced plastic. Soft plastic zone in upper handle section used for gripping.

**Application:** For precise stripping and cutting of single, multi and fine-wired cables for many tasks in the electronics industry.

Order-No.	mm	mm	Ø mm	AWG	g	SB
33847	190	7½	0.02-10	34-8	135	x 1



### 246 73 SB Stripping cassette for automatic stripping pliers. Blister packed.

**Design:** Cassette with straight blade.

Order-No.	Ø mm	AWG	g	SB
33846	0.02-10	34-8	7	x 1

# Wiha crimp tools and stripping tools.

## Stripping tools.



### 246 22 02 Cable stripper.

**Design:** Comfortable stripping with continuously adjustable cutting depth per adjusting screw and self-turning inner cutter. Damage to the inner conductor is therefore eliminated. Self-tensioning holding lever for safe cable guide. With cutter and hooked blade incl. safety cap for transport and storage. Additional spare blades included in the tool. Ergonomically designed construction.

**Material:** Impact resistant plastic housing made of Polyamide reinforced with glass-fibre. Hooked blade and cutter are made of hardened steel.

**Application:** Precise, fast and safe stripping of all common round cable from  $\varnothing$  4 mm – 28 mm. Self-turning inner cutter for circular and longitudinal cutting.

Order-No.	mm	II	Ø mm	g	SB	
35969	165	6 ½	4.0-28	80		1
35538	165	6 ½	4.0-28	80	x	1



**NEW**  **246 80 SB Cable stripping knife.**  
**Blister packed.**

**Standards:** Manufactured acc. to IEC 60900:2012.

**Design:** Rugged, fixed blade with straight cutting edge. Non-slip soft component in the handle ensures an optimal hold and more safety. Protective cap for safe transport and protection of cutting edges.

**Material:** Insulating multi-component handle. Blade of hardened, non-rusting steel.

**Application:** For stripping and cutting open of insulation, particularly large cables and the various layers of multi-insulated cables. For all work on or around electrical components up to 1,000 V AC.

Order-No.	mm	II	g	SB	
38798	200	8	120	x	1

## Crimping and stripping tool.



### 246 78 SB Stripping knife for round cables. Blister packed.

**Standards:** Manufactured acc. to IEC 60900:2012.

**Design:** Robust, fixed, sickle-shaped hooked blade. Shoe-shaped blade tip limits the cutting depth and prevents damage to conductors. Protective cap for safe transport and protection of cutting edges.

**Material:** Insulating multi-component handle. Blade of hardened, non-rusting steel.

**Application:** For stripping thick cables and cutting open the various layers of multi-insulated cables. For all work on or around electrical components up to 1,000 V AC.

Order-No.	mm	II	g	SB	
36053	200	8	120	x	1



### 246 77 SB Stripping tool for round cables. Blister packed.

**Design:** Double layered, folding stripping tool with opening spring and locking mechanism. Setting of cutting depth not required. Ergonomically designed tool body for non-slip, safe work.

**Material:** Housing of glass-fibre reinforced polyamide.

**Application:** Flush stripping of round and damp-proof cable from  $\varnothing$  8 – 13 mm (e.g. NYM 3 x 1.5 mm<sup>2</sup> to 5 x 2.5 mm<sup>2</sup>), also for hard-to-reach locations e.g. ceiling and wall areas, in junction boxes, distribution boxes, switch cabinets etc.

Order-No.	mm	II	Ø mm	g	SB	
36052	125	5	8-13	45	x	1



### 246 76 SB Stripping tool for coaxial cables. Blister packed.

**Design:** Double layered, folding stripping tool with opening spring and locking mechanism. Setting of cutting depth not required. Extra-long tool body for optimal handling. With 5.0 - 20.0 mm length scale.

**Material:** Housing of glass-fibre reinforced polyamide.

**Application:** Incremental stripping of all commonly used coaxial cables (e.g. antenna and transmission cables) from 4.8 – 7.5 mm outer diameter. Also suitable for stripping of round cables (e.g. NYM 3 x 0.75 mm<sup>2</sup>, PVC flex 10 mm<sup>2</sup> and 16mm<sup>2</sup>).

Order-No.	mm	II	Ø mm	g	SB	
36051	110	4 ¼	4.8-7.5	30	x	1

# Wiha Industrial.

Comfortable in your hand, versatile in application.



product  
design  
award

2011



Focus Energy  
Silver 2006



For industrial applications in particular, the diversity of tools and the demands made upon them have increased dramatically. Here the Wiha Industrial pliers series has proven to be ideal. It combines the advantages of the Wiha Professional and Classic series: pleasant handling, a concise shape and a flexible range.

With DynamicJoint, Wiha Industrial implements the new generation of precision joints: cuts are powerful and at the same time more energy-saving than ever before. Tests have proven: significantly less expenditure of effort is a convincing argument.



### Wiha Info



**Wiha DynamicJoint – A new dimension in strength and durability**

- **Innovative:**  
Optimised joint construction
- **Effective:**  
Low loss of force means less force needed for cutting
- **Permanent:**  
Optimal performance even after thousands of cuts

*Wiha Industrial pliers offer a secure hold when gripping, bending and cutting soft and hard wire.*



### Wiha Industrial.

- **Powerful**  
With DynamicJoint®, the high quality joint construction for simple, long-term cutting efficiency
- **As hard as steel**  
Pliers head drop forged from high quality steels
- **Robust and durable**  
Cutting edges are individually tempered and additionally induction hardened to approx. 64 HRC; joints are extremely wear resistant and withstand high stresses, with high-quality riveting
- **Ergonomic**  
Extra wide handle backs, with soft and hard zones perfectly distributed across the handle
- **Attractive**  
An appealing design, with a multi-polished head



**Safety note:**  
When working with cutting pliers – beware of wire ends flying away. Please wear safety glasses.

**Combination and high leverage combination pliers.**



**Z 01 0 02** Combination pliers Industrial.

Standards: DIN ISO 5746.  
Head shape: Extra long cutting edge for flat and round cables.  
Design: OptiGrip - the newly designed gripping surface with 'triple-point support' ensures optimal hold of the workpiece while working. Cutting edges additionally induction hardened to approx. 64 HRC. The Wiha DynamicJoint® ensures optimal transmission of hand strength to the cutting edges.  
Material: High quality C 70 tool steel, tempered.  
Application: General purpose pliers for gripping and holding as well as cutting soft and hard wires and cables.

Order-No.	mm	II	○	●	●	g	SB	☐
30979	160	6 ½	3.1	2.0	1.6	195		5
34565	160	6 ½	3.1	2.0	1.6	195	x	5
30826	180	7	3.4	2.2	1.8	245		5
34307	180	7	3.4	2.2	1.8	245	x	5
30978	200	8	3.8	2.5	2.0	325		5
34308	200	8	3.8	2.5	2.0	325	x	5



**Z 02 0 02** High-leverage combination pliers Industrial.

Standards: DIN ISO 5746.  
Head shape: Extra long cutting edge for flat and round cables.  
Design: OptiGrip - the newly designed gripping surface with 'triple-point support' ensures optimal hold of the workpiece while working. Particularly powerful leverage results in 40% less effort being required for cutting tasks compared with standard combination pliers. Cutting edges additionally inductively hardened to approx. 64 HRC, therefore also appropriate for cutting piano wire. The Wiha DynamicJoint® ensures optimal transmission of hand strength to the cutting edges.  
Material: High quality C 70 tool steel, specially tempered.  
Application: Power assisted general purpose pliers for gripping and holding as well as cutting wires and cables ranging in hardness from soft to extremely hard.

Order-No.	mm	II	○	●	●	g	SB	☐
32319	200	8	3.8	2.8	2.3	315		5
34566	200	8	3.8	2.8	2.3	315	x	5
32320	225	9	4.4	3.0	2.5	390		5
34567	225	9	4.4	3.0	2.5	390	x	5

**Needle nose pliers.**



**Z 05 0 02** Needle nose pliers Industrial with cutting edge.

Standards: DIN ISO 5745.  
Head shape: Straight shape.  
Design: Extra long cutting edge for flat and round cables. Gripping surfaces partially serrated in parts. Cutting edges additionally induction hardened to approx. 64 HRC.  
Material: High quality C 70 tool steel, tempered.  
Application: Gripping and holding as well as cutting soft and hard wires and cables. Preferred choice in the mechanical sector.

Order-No.	mm	II	○	●	●	g	SB	☐
32322	160	6 ½	2.5	1.8	1.2	155		5
34309	160	6 ½	2.5	1.8	1.2	156	x	5
32323	200	8	3.2	2.2	1.6	200		5
34515	200	8	3.2	2.2	1.6	200	x	5



**Z 05 1 02** Needle nose pliers Industrial with cutting edge.

Standards: DIN ISO 5745.  
Head shape: Angled, approx. 40°.  
Design: Extra long cutting edge for flat and round cables. Gripping surfaces partially serrated in parts. Cutting edges additionally induction hardened to approx. 64 HRC.  
Material: High quality C 70 tool steel, tempered.  
Application: Gripping and holding as well as cutting soft and hard wires and cables. Preferred choice in the mechanical sector.

Order-No.	mm	II	○	●	●	g	SB	☐
32324	160	6 ½	2.5	1.8	1.2	155		5
34569	160	6 ½	2.5	1.8	1.2	155	x	5
32328	200	8	3.2	2.2	1.6	200		5
34570	200	8	3.2	2.2	1.6	200	x	5

**Wiha Info**

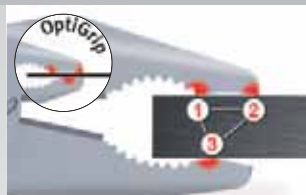

**Opti-Grip – optimal grip due to newly designed gripping surfaces**

- **A firm hold:** The 'triple-point support' protects the workpiece from twisting or slipping.
- **Highly effective:** Optimum grip even with a large jaw opening – and at the same time significantly less force needed
- **A wide selection:** Now in standard Wiha combination pliers and high leverage combination pliers



# Wiha Industrial.

Comfortable in your hand, versatile in application.

## Diagonal cutters and heavy duty diagonal cutters.



### Z 12 0 02 Diagonal cutters Industrial.

Standards: DIN ISO 5749.  
 Head shape: Semi-circular, swedish style.  
 Design: Low wear lap joint, riveted and able to withstand high loads. The Wiha DynamicJoint® ensures optimal transmission of hand strength to the cutting edges. Lightweight action, clean cutting achieved by specially milled precision cutting edges. Long term cutting is achieved through additional inductive hardening to approx. 64 HRC.  
 Material: High quality C 70 tool steel, tempered.  
 Application: For soft and hard wires.

Order-No.	mm	II	○	●	●	●	g	SB	≡
30975	140	5 ½	4.0	2.5	1.8	1.4	160		5
34311	140	5 ½	4.0	2.5	1.8	1.4	160	x	5
30827	160	6 ½	4.0	2.8	2.0	1.6	200		5
34516	160	6 ½	4.0	2.8	2.0	1.6	200	x	5
30976	180	7	4.0	3.0	2.5	1.8	250		5
34571	180	7	4.0	3.0	2.5	1.8	250	x	5



### Z 16 0 02 Heavy-duty diagonal cutters Industrial.

Standards: DIN ISO 5749.  
 Head shape: Semi-circular.  
 Design: Low wear lap joint, riveted and able to withstand high levels of load. The Wiha DynamicJoint® ensures optimal transmission of hand strength to the cutting edges. Lightweight action, clean cutting achieved by specially milled precision cutting edges. Long term cutting is achieved through additional inductive hardening to approx. 64 HRC.  
 Material: High quality C 70 tool steel, tempered.  
 Application: Power assisted, all round diagonal cutter for soft wire as well as the most stringent of demands made by piano wires.

Order-No.	mm	II	○	●	●	g	SB	≡
32333	160	6 ½	3.5	2.5	2.0	190		5
34572	160	6 ½	3.5	2.5	2.0	190	x	5
32339	180	7	3.8	2.7	2.3	260		5
34517	180	7	3.8	2.7	2.3	260	x	5
32341	200	8	4.2	3.0	2.5	315		5
34573	200	8	4.2	3.0	2.5	315	x	5

## Diagonal cutters and heavy-duty end cutting nippers.



NEW

### Z 18 0 02 BiCut Industrial - switchable high-performance diagonal cutters.

Standards: Based on DIN ISO 5749.  
 Head shape: Semi-circular.  
 Design: Clever - BiCut does the job of two pairs of pliers. Powerful - Up to 50% less hand strength required for cutting. Power - Cutting force doubled for extremely hard materials. Comfortable - Easily switch between the two strengths in a one handed operation. Robust and durable - Cutter blades induction hardened up to 64 HRC.  
 Material: Hard as steel - Drop forged of high-quality C70 steel.  
 Application: For cutting various materials from soft to extremely hard, such as cables, nails, screws, bolts, wire cable, spring wire, chains, etc.

Order-No.	mm	II	○	●	g	SB	≡
38189	200	8	3.5	3	350		5
38982	200	8	3.5	3	350	x	5



### Z 17 0 02 Industrial heavy-duty end cutting nippers.

Standards: DIN ISO 5748.  
 Head shape: Classic style.  
 Design: Low wear lap joint, riveted and able to withstand high levels of load. Striking high quality cutting edge with high cutting performance and low application of force due to highly precise processing. Good durability due to additional induction hardening of cutting edges to approx. 64 HRC.  
 Material: High-quality C 70 tool steel, hardened, polished and chrome-plated.  
 Application: Power assisted, all round diagonal cutter for soft wires as well as demanding piano wires. Also appropriate for binding (plaiting) and cutting wire netting in reinforced concrete structures.

Order-No.	mm	II	○	●	●	g	SB	≡
36035	160	6 ½	3.5	2.5	1.6	180		5
36982	160	6 ½	3.5	2.5	1.6	180	x	5
36036	180	7	3.8	2.8	1.8	200		5
36983	180	7	3.8	2.8	1.8	200	x	5
36037	200	8	4.0	3.0	2.0	220		5
36984	200	8	4.0	3.0	2.0	220	x	5



**Safety note:**

When working with cutting pliers –  
beware of wire ends flying away.  
Please wear safety glasses.

**Stripping pliers.****Z 55 0 02 Stripping pliers Industrial.**

Standards: DIN ISO 5743.

Head shape: Precision cutting edge prism for even cutting of cable insulation.

Design: An easy to use adjusting screw allows the stripping diameter to be set.  
Opening spring for effortless and sensitive handling of pliers.

Material: High quality C 70 tool steel, tempered.

Application: Simple stripping of cables and strands of up to  $\varnothing$  5 mm/ 10 mm<sup>2</sup> conductor cross-section.

Order-No.	mm	II	Ø	mm <sup>2</sup>	g	SB	
32345	160	6 ½	5	10	155		5
34313	160	6 ½	5	10	155	x	5

**Needle-nose and round-nose pliers.****Z 07 0 02 Long flat-nose pliers Industrial.**

Standards: DIN ISO 5745.

Head shape: Extra long head.

Design: Gripping surfaces serrated and inductively hardened.

Material: High-quality tool steel, tempered.

Application: Gripping and right-angled bending of wires and sheet metal parts.

Order-No.	mm	II	g	SB	
32330	160	6 ½	160		5
34310	160	6 ½	160	x	5

**Z 09 0 02 Long round-nose pliers Industrial.**

Standards: DIN ISO 5745.

Head shape: Extra long head.

Design: Gripping surfaces serrated and inductively hardened.

Material: High-quality tool steel, tempered.

Application: Gripping and bending of wires and sheet metal parts.

Order-No.	mm	II	g	SB	
32332	160	6 ½	140		5
34568	160	6 ½	140	x	5

**Wiha Info**

**Wiha BiCut -**  
Double the power at the  
press of a button

- **Clever:**  
BiCut does the job of two pairs of pliers.
- **Power:**  
Cutting force doubled for extremely hard materials.
- **Powerful:**  
Up to 50% less hand strength required for cutting.

**Wiha Info**

**Wiha DynamicJoint -**  
A new dimension in  
strength and durability

- **Innovative:**  
Optimised joint construction
- **Effective:**  
Low loss of force means less force needed for cutting
- **Permanent:**  
Optimal performance even after thousands of cuts

**Details of cutting results of cutting pliers.**

Symbol/Types of wire	Example	Tensile strength ca. N/mm <sup>2</sup>
○ <b>Soft wire</b>	Copper, aluminium	220 - 250
◐ <b>Medium hard wire</b>	Iron nail	750 - 800
◑ <b>Hard wire</b>	Spring wire, steel nails	1.600 - 1.800
● <b>Piano wire</b>	Hardened spring steel	2.200 - 2.300

Test wires standardised in DIN ISO 5744

# Wiha Industrial.

Comfortable in your hand, versatile in application.

## Water pump pliers.



### Z 21 0 02 Water pump pliers Industrial.

Standards: DIN ISO 8976.  
 Head shape: Narrow head, therefore also appropriate for work in small spaces.  
 Design: Precision adjustment joint, box type, providing optimum adaptation to object to be gripped. Long durability achieved by additional inductive hardening of gripper jaws.  
 Material: High quality chrome-vanadium molybdenum steel, tempered.  
 Application: For gripping and holding pipes and angular profiles such as hex nuts in the installation area.

Order-No.	mm	II	O	g	SB	
36038	180	7	1	30	170	5
36985	180	7	1	30	170	x 5
32342	250	10	2	50	380	5
34312	250	10	2	50	380	x 5
36039	300	12	2 1/2	63	640	5
36986	300	12	2 1/2	63	640	x 5



### Z 22 0 02 Water pump pliers Industrial with push button adjustment.

Standards: DIN ISO 8976.  
 Head shape: Extra narrow head, therefore also appropriate for work in difficult to access areas.  
 Design: Precision adjustment joint, box type, providing optimum adaptation to object to be gripped. Rapid and simple push button setting and locking. Long durability achieved by additional inductive hardening of gripper jaws.  
 Material: High quality chrome-vanadium molybdenum steel, tempered.  
 Application: For gripping and holding pipes and angular profiles such as hex nuts in the installation area.

Order-No.	mm	II	O	g	SB	
36040	180	7	1	30	175	5
36987	180	7	1	30	175	x 5
32352	250	10	2	50	400	5
34518	250	10	2	50	400	x 5
36041	300	12	2 1/2	63	670	5
36988	300	12	2 1/2	63	670	x 5

## Display.



### Z 99 0 005 02VH Industrial pliers display.

Card display with 10 pieces.  
 Design: Pliers of high quality tool steel, hardened and multi-polished. Multi-component handles with slip guard for safe and comfortable operation.  
 Size 25.5 x 25.5 x 25.5 cm (WxDxH).  
 Weight 3.34 kg.

Application: The pliers selection for demanding users in trade and industry.

Order-No.	Series	
36065	Z 99 0 005 02VH	1
Z 01 0 02	Combination pliers Industrial. With Wiha DynamicJoint®.	
	180 mm 7"	
Z 02 0 02	High-leverage combination pliers Industrial.	
	200 mm 8"	
Z 05 0 02	Needle nose pliers Industrial with cutting edge.	
	160 mm 6 1/2"	
Z 12 0 02	Diagonal cutters Industrial. With Wiha DynamicJoint®.	
	160 mm 6 1/2"	
Z 16 0 02	Heavy-duty diagonal cutters Industrial.	
	180 mm 7"	

# Wiha Industrial electric.

Highest safety even for non-chromed pliers.



*Wiha Industrial electric heavy-duty diagonal cutters are incomparably good and durable when cutting electrical cables and for tough cutting jobs.*

*Outstanding cutting quality due to high-quality tool steel C70*

*Multiple polished heads*

*Comfortable, easy stripping using precise cutting edges and spring in the joint which can't be lost.*

*Slipping off is prevented by a limit.*



**Wiha Industrial electric.**

- **Uncompromisingly safe**  
Manufactured and inspected according to IEC 60900:2012, one-off testing at 10,000 V, GS mark for inspected safety, VDE certified

- **Powerful**  
With DynamicJoint®, the special joint for energy-saving and durable excellent cutting results and OptiGrip, the reshaped grip surface for an optimal hold

- **As hard as steel**  
Pliers head drop forged from high quality steels

- **Robust and durable**  
Cutting edges are individually tempered and additionally induction hardened, joints are extremely wear resistant and can withstand high stresses, and have high-quality riveting.

- **Ergonomic**  
Extra wide handle backs, with soft and hard zones perfectly distributed across the handle

- **Attractive**  
Visually appealing design with a multi-polished head and award-winning pliers handles

Wiha Industrial electric pliers join the advantages of Wiha Industrial pliers while simultaneously ensuring one hundred percent safety when working near live parts. Wiha Industrial electric pliers are uncompromisingly safe, whether in industrial electrical assembly, maintenance, servicing or electrical installation in construction.

The award-winning design of the two-component handles comply with the latest ergonomic findings in terms of their soft and hard zone distribution and their outer geometry while simultaneously guaranteeing the utmost safety regarding the strict standards of IEC 60900 and the VDE.



## Wiha Info



**Wiha DynamicJoint –**  
A new dimension in strength and durability

- **Innovative:**  
Optimised joint construction
- **Effective:**  
Low loss of force means less force needed for cutting
- **Permanent:**  
Optimal performance even after thousands of cuts

*Safety is at the top of the list - all Wiha Industrial electric pliers fulfil the strict standards of IEC 60900 and the VDE.*



Approved for work in the area of live parts up to 1,000 V AC or 1,500 V DC. When working with VDE tools, observe the national safety and accident prevention regulations.

# Wiha Industrial electric.

Highest safety even for non-chromed pliers.

## Combination pliers and high-leverage combination pliers.



**NEW**  
**Z 01 0 09**

1000 V  
IEC 60900:2012

**Industrial electric combination pliers.**  
**Individually tested protective insulation 1,000 V AC, VDE and GS tested.**

- Standards: DIN ISO 5746.  
Manufactured acc. to IEC 60900:2012.
- Head shape: Extra long cutting edge for flat and round cables.
- Design: With multi-polished head. OptiGrip - the newly designed gripping surface with 'triple-point support' ensures optimal hold of the workpiece while working. Cutting edges additionally induction hardened to approx. 64 HRC. The Wiha DynamicJoint® ensures optimal transmission of hand strength to the cutting edges.
- Material: High quality C 70 tool steel, tempered.
- Application: General purpose pliers for gripping and holding as well as cutting soft and hard wires and cables. For all work on or around electrical components up to 1,000 V AC.

Order-No.	mm	II	○	●	●	g	SB	SB
33186	180	7	3.4	2.2	1.8	245		5
38855	180	7	3.4	2.2	1.8	245	x	5



**NEW**  
**Z 02 0 09**

1000 V  
IEC 60900:2012

**Industrial electric high-leverage combination pliers.**  
**Individually tested protective insulation 1,000 V AC, VDE and GS tested.**

- Standards: DIN ISO 5746. Manufactured acc. to IEC 60900:2012.
- Head shape: Extra long cutting edge for flat and round cables.
- Design: With multi-polished head. OptiGrip - the newly designed gripping surface with 'triple-point support' ensures optimal hold of the workpiece while working. Particularly powerful leverage results in 40% less effort being required for cutting tasks compared with standard combination pliers. Cutting edges additionally inductively hardened to approx. 64 HRC, therefore also appropriate for cutting piano wire. The Wiha DynamicJoint® ensures optimal transmission of hand strength to the cutting edges.
- Material: High quality C 70 tool steel, specially tempered.
- Application: Power assisted general purpose pliers for gripping and holding as well as cutting wires and cables ranging in hardness from soft to extremely hard. For all work on or around electrical components up to 1,000 V AC.

Order-No.	mm	II	○	●	●	g	SB	SB
35465	225	9	4.4	3	2.5	390		5
38856	225	9	4.4	3	2.5	390	x	5

## Needle nose pliers.



**NEW**  
**Z 05 0 09**

1000 V  
IEC 60900:2012

**Industrial electric needle nose pliers with cutting edge.**  
**Individually tested protective insulation 1,000 V AC, VDE and GS tested.**

- Standards: DIN ISO 5745. Manufactured acc. to IEC 60900:2012.
- Head shape: Straight shape.
- Design: With multi-polished head. Extra long cutting edge for flat and round cables. Gripping surfaces partially serrated in parts. Cutting edges additionally induction hardened to approx. 64 HRC.
- Material: High quality C 70 tool steel, tempered.
- Application: Gripping and holding as well as cutting soft and hard wires and cables. Preferred choice in the electrical sectors. For all work on or around electrical components up to 1,000 V AC.

Order-No.	mm	II	○	●	●	g	SB	SB
35477	160	6 1/2	2.5	1.8	1.2	155		5
38857	160	6 1/2	2.5	1.8	1.2	155	x	5
33178	200	8	2.8	2	1.6	200		5
38858	200	8	2.8	2	1.6	200	x	5



**NEW**  
**Z 05 1 09**

1000 V  
IEC 60900:2012

**Industrial electric needle nose pliers with cutting edge.**  
**Individually tested protective insulation 1,000 V AC, VDE and GS tested.**

- Standards: DIN ISO 5745. Manufactured acc. to IEC 60900:2012.
- Head shape: Angled, approx. 40°.
- Design: With multi-polished head. Extra long cutting edge for flat and round cables. Gripping surfaces partially serrated in parts. Cutting edges additionally induction hardened to approx. 64 HRC.
- Material: High quality C 70 tool steel, tempered.
- Application: Gripping and holding as well as cutting soft and hard wires and cables. Preferred choice in the electrical sectors. For all work on or around electrical components up to 1,000 V AC.

Order-No.	mm	II	○	●	●	g	SB	SB
35462	200	8	2.8	2	1.6	200		5
38859	200	8	2.8	2	1.6	200	x	5

### Details of cutting results of cutting pliers.

Symbol/Types of wire	Example	Tensile strength ca. N/mm <sup>2</sup>
○ Soft wire	Copper, aluminium	220 - 250
● Medium hard wire	Iron nail	750 - 800
● Hard wire	Spring wire, steel nails	1.600 - 1.800
● Piano wire	Hardened spring steel	2.200 - 2.300

Test wires standardised in DIN ISO 5744





**Safety note:**  
When working with cutting pliers – beware of wire ends flying away. Please wear safety glasses.

**Diagonal cutters and heavy duty diagonal cutters.**



**NEW**  
**Z12009**

1000 V  
IEC 60900:2012

**Industrial electric diagonal cutters.**  
Individually tested protective insulation 1,000 V AC, VDE and GS tested.

Standards: DIN ISO 5749. Manufactured acc. to IEC 60900:2012.  
Head shape: Semi-circular, swedish style.  
Design: With multi-polished head.  
Low wear lap joint, riveted and able to withstand high loads. Lightweight action, clean cutting achieved by specially milled precision cutting edges. Long term cutting is achieved through additional inductive hardening to approx. 64 HRC. The Wiha DynamicJoint® ensures optimal transmission of hand strength to the cutting edges.  
Material: High quality C 70 tool steel, tempered.  
Application: Universal cutter for cutting soft and hard wires and cables, also suitable for cutting and stripping cables. For all work on or around electrical components up to 1,000 V AC.

Order-No.	mm	II	○	●	●	●	g	SB	mm
38633	140	5 1/2	4	2.5	1.8	1.4	160		5
38860	140	5 1/2	4	2.5	1.8	1.4	160	x	5
33177	160	6 1/2	4	2.8	2	1.6	200		5
38861	160	6 1/2	4	2.8	2	1.6	200	x	5



**NEW**  
**Z16009**

1000 V  
IEC 60900:2012

**Industrial electric heavy-duty diagonal cutters.**  
Individually tested protective insulation 1,000 V AC, VDE and GS tested.

Standards: DIN ISO 5749. Manufactured acc. to IEC 60900:2012.  
Head shape: Semi-circular.  
Design: With multi-polished head. Low wear lap joint, riveted and able to withstand high levels of load. Lightweight action, clean cutting achieved by specially milled precision cutting edges. Long term cutting is achieved through additional inductive hardening to approx. 64 HRC. The Wiha DynamicJoint® ensures optimal transmission of hand strength to the cutting edges.  
Material: High quality C 70 tool steel, specially tempered.  
Application: Power-assisted all-round diagonal cutter for cutting soft to extremely hard wires and cables. For all work on or around electrical components up to 1,000 V AC.

Order-No.	mm	II	○	●	●	●	g	SB	mm
38634	160	6 1/2	3.5	2.5	2	190			5
38862	160	6 1/2	3.5	2.5	2	190	x		5
38635	180	7	3.8	2.7	2.3	260			5
38863	180	7	3.8	2.7	2.3	260	x		5
35464	200	8	4.2	3	2.5	315			5
38864	200	8	4.2	3	2.5	315	x		5

**Cable cutters.**



**NEW**  
**Z 50 1 09**

1000 V  
IEC 60900:2012

**Industrial electric cable cutter.**  
Individually tested protective insulation 1,000 V AC, VDE and GS tested.

Standards: Manufactured acc. to IEC 60900:2012.  
Head shape: Classic cutting form.  
Design: With multi-polished head. Light, energy-saving and clean cutting with specially ground precision cutting edges. Durable cutting edges due to additional induction hardening to approx. 58 HRC. Safety stop prevents finger injuries after cutting.  
Material: Special tool steel C 70, tempered.  
Application: Cable cutter for cutting of copper and aluminium cables without crushing, also suitable for stripping. Not for steel cable, wires and copper conductors with hard coatings. For all work on or around electrical components up to 1,000 V AC.

Order-No.	mm	II	Ø	mm <sup>2</sup>	g	SB	mm
38636	160	6 1/2	16	50	190		5
38865	160	6 1/2	16	50	190	x	5
35479	200	8	20	60	305		5
38866	200	8	20	60	305	x	5



**Wiha Info**



**Wiha DynamicJoint – A new dimension in strength and durability**

- **Innovative:** Optimised joint construction
- **Effective:** Low loss of force means less force needed for cutting
- **Permanent:** Optimal performance even after thousands of cuts

**Wiha Info**

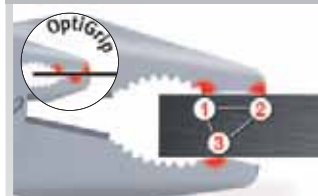

**Opti-Grip – optimal grip due to newly designed gripping surfaces**

- **A firm hold:** The 'triple-point support' protects the workpiece from twisting or slipping.
- **Highly effective:** Optimum grip even with a large jaw opening – and at the same time significantly less force needed
- **A wide selection:** Now in standard Wiha combination pliers and high leverage combination pliers



# Wiha Industrial electric.

Highest safety even for non-chromed pliers.

## Stripping pliers. Pliers set.



**NEW**  
**Z 55 0 09**



**Industrial electric stripping pliers.**  
Individually tested protective insulation 1,000 V AC, VDE and GS tested.

- Standards: DIN ISO 5743.  
Manufactured acc. to IEC 60900:2012.
- Head shape: Precision cutting edge prism for even cutting of cable insulation.
- Design: With multi-polished head.  
An easy to use adjusting screw allows the stripping diameter to be set.  
Opening spring for effortless and sensitive handling of pliers.
- Material: High quality C 70 tool steel, tempered.
- Application: Simple stripping of cables and strands of up to  $\varnothing$  5 mm/ 10 mm<sup>2</sup> conductor cross-section.  
For all work on or around electrical components up to 1,000 V AC.

Order-No.	mm	II	Ø	mm <sup>2</sup>	g	SB	
36711	160	6 1/2	5	10	155		5
38867	160	6 1/2	5	10	155	x	5



**NEU**  
**Z 99 0 001 09**



**Industrial electric pliers set, 3-pcs.**  
Individually tested protective insulation 1,000 V AC, VDE and GS tested.

- Design: Pliers of high quality tool steel, hardened and multi-polished.  
Multi-component handles with slip guard for safe and comfortable operation.  
Individually tested for electrical safety in accordance with IEC 60900:2012.  
Weight 820 g.
- Application: All tools suitable for use with or near live components up to 1,000 V AC.  
For all work on or around electrical components up to 1,000 V AC.

Order-No.	Series	
38637	Z 99 0 001 09	1
	Z 12 0 09	Industrial electric diagonal cutters. 160 mm 6 1/2"
	Z 01 0 09	Industrial electric combination pliers. 180 mm 7"
	Z 05 0 09	Needle nose pliers Professional electric with cutting edge. 200 mm 8"

## Display.



**NEU**  
**Z 99 0 005 09VH**



**Industrial electric pliers display.**  
Card display with 10 pieces.  
Insulation up to 1,000 V AC, GS-mark.

- Design: Pliers of high quality tool steel, hardened and multi-polished.  
Multi-component handles with slip guard for safe and comfortable operation.  
Size 25.5 x 25.5 x 25.5 cm (WxDxH).  
Weight 3.18 kg.
- Application: The pliers selection for demanding electricians.  
For all work on or around electrical components up to 1,000 V AC.

Order-No.	Series	
38638	Z 99 0 005 09VH	1
	Z 01 0 09	Industrial electric combination pliers. 180 mm 7"
	Z 05 0 09	Needle nose pliers Professional electric with cutting edge. 200 mm 8"
	Z 12 0 09	Industrial electric diagonal cutters. 160 mm 6 1/2"
	Z 16 0 09	Industrial electric heavy-duty diagonal cutters. 180 mm 7"
	Z 55 0 09	Industrial electric stripping pliers. 160 mm 6 1/2"

# Wiha Classic.

The complete workshop range.



product  
design  
award

2011 ■



Multiple polished heads

Body fully hardened

Anti-slip, oil and thinner resistant handle



**Wiha Classic.**

Pipe, wire, sheet metal parts, cable, springs, nails, bolts and screws, safety rings, wire-end sleeves: the tool needs to be as diverse as the materials and tasks it faces in everyday work.

The most suitable prerequisites are supplied by the Wiha Basic range of pliers: over 80 pliers have been tested in all possible application scenarios.

And Wiha continues to perfect them: DynamicJoint for example, the progressive development of the joint construction, ensures significantly easier cutting. And the precise Wiha MagicTips stabilise and protect the circlip pliers.

Wiha Basic – tried-and-true quality at a competitive price, with an appealing design.



*All-round end cutting nippers for soft wire as well as for tough cutting of hard wire.*

- **Powerful**  
With DynamicJoint®, the high quality joint construction for simple, long-term cutting efficiency
- **Extra rugged, right up to the tips**  
With Wiha MagicTips®, the precision tips that ensure a firm hold with unexcelled stability
- **As hard as steel**  
Pliers head drop forged from high quality steels
- **Robust and durable**  
Cutting edges are individually tempered and additionally induction hardened to approx. 64 HRC; joints are extremely wear resistant and withstand high stresses, with high-quality riveting
- **Ergonomic**  
An ergonomic handle shape for optimal handling
- **Attractive**  
An appealing design, with a multi-polished head

# Wiha Classic.

The complete workshop range.

## Combination pliers and high-leverage combination pliers.



### Z 01 0 01 Classic combination pliers.

**Standards:** DIN ISO 5746.  
**Head shape:** Extra long cutting edge for flat and round cables.  
**Design:** OptiGrip - the newly designed gripping surface with 'triple-point support' ensures optimal hold of the workpiece while working. Cutting edges additionally induction hardened to approx. 64 HRC. The Wiha DynamicJoint® ensures optimal transmission of hand strength to the cutting edges.  
**Material:** High quality C 70 tool steel, tempered.  
**Application:** General purpose pliers for gripping and holding as well as cutting soft and hard wires and cables.

Order-No.	mm	II	○	●	●	g	SB	☑
26703	160	6 ½	3.1	2.0	1.6	160		5
27325	160	6 ½	3.1	2.0	1.6	160	x	5
26706	180	7	3.4	2.2	1.8	205		5
27336	180	7	3.4	2.2	1.8	205	x	5
26709	200	8	3.8	2.5	2.0	280		5
27337	200	8	3.8	2.5	2.0	280	x	5



### Z 02 0 01 Classic high-leverage combination pliers.

**Standards:** DIN ISO 5746.  
**Head shape:** Extra long cutting edge for flat and round cables.  
**Design:** OptiGrip - the newly designed gripping surface with 'triple-point support' ensures optimal hold of the workpiece while working. Particularly powerful leverage results in 40% less effort being required for cutting tasks compared with standard combination pliers. Cutting edges additionally inductively hardened to approx. 64 HRC, therefore also appropriate for cutting piano wire. The Wiha DynamicJoint® ensures optimal transmission of hand strength to the cutting edges.  
**Material:** High quality C 70 tool steel, specially tempered.  
**Application:** Power assisted general purpose pliers for gripping and holding as well as cutting wires and cables ranging in hardness from soft to extremely hard.

Order-No.	mm	II	○	●	●	g	SB	☑
26712	200	8	3.8	2.8	2.3	275		5
27338	200	8	3.8	2.8	2.3	275	x	5
26715	225	9	4.2	3.0	2.5	330		5
27339	225	9	4.2	3.0	2.5	330	x	5

## Needle-nose and round-nose pliers.



### Z 05 0 01 Classic needle nose pliers with cutting edge.

**Standards:** DIN ISO 5745.  
**Head shape:** Straight shape.  
**Design:** Extra long cutting edge for flat and round cables. Gripping surfaces partially serrated in parts. Cutting edges additionally induction hardened to approx. 64 HRC.  
**Material:** High quality C 70 tool steel, tempered.  
**Application:** Gripping and holding as well as cutting soft and hard wires and cables. Preferred choice in the mechanical sector.

Order-No.	mm	II	○	●	●	g	SB	☑
26718	160	6 ½	2.5	1.8	1.2	120		5
27340	160	6 ½	2.5	1.8	1.2	120	x	5
26721	200	8	3.2	2.2	1.6	165		5
27341	200	8	3.2	2.2	1.6	165	x	5



### Z 05 1 01 Classic needle nose pliers with cutting edge.

**Standards:** DIN ISO 5745.  
**Head shape:** Angled, approx. 40°.  
**Design:** Extra long cutting edge for flat and round cables. Gripping surfaces partially serrated in parts. Cutting edges additionally induction hardened to approx. 64 HRC.  
**Material:** High quality C 70 tool steel, tempered.  
**Application:** Gripping and holding as well as cutting soft and hard wires and cables. Preferred choice in the mechanical sector.

Order-No.	mm	II	○	●	●	g	SB	☑
26723	160	6 ½	2.5	1.8	1.2	120		5
27342	160	6 ½	2.5	1.8	1.2	120	x	5
26725	200	8	3.2	2.2	1.6	165		5
27343	200	8	3.2	2.2	1.6	165	x	5

### Wiha Info



**Wiha DynamicJoint – A new dimension in strength and durability**

- **Innovative:** Optimised joint construction
- **Effective:** Low loss of force means less force needed for cutting
- **Permanent:** Optimal performance even after thousands of cuts

### Wiha Info

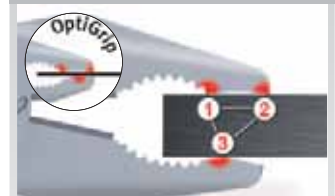

**Opti-Grip – optimal grip due to newly designed gripping surfaces**

- **A firm hold:** The 'triple-point support' protects the workpiece from twisting or slipping.
- **Highly effective:** Optimum grip even with a large jaw opening – and at the same time significantly less force needed
- **A wide selection:** Now in standard Wiha combination pliers and high leverage combination pliers

**Safety note:**

When working with cutting pliers – beware of wire ends flying away. Please wear safety glasses.

**Diagonal cutters and heavy duty diagonal cutters.****Z 12 0 01****Classic diagonal cutters.**

Standards: DIN ISO 5749.

Head shape: Semi-circular, swedish style.

Design: Low wear lap joint, riveted and able to withstand high loads.

The Wiha DynamicJoint® ensures optimal transmission of hand strength to the cutting edges.

Lightweight action, clean cutting achieved by specially milled precision cutting edges.

Long term cutting is achieved through additional inductive hardening to approx. 64 HRC.

Material: High quality C 70 tool steel, tempered.

Application: For cutting of soft and hard wire.

Order-No.	mm	II	○	●	●	●	g	SB	
26738	140	5 ½	4.0	2.5	1.8	1.4	130		5
27346	140	5 ½	4.0	2.5	1.8	1.4	130	x	5
26739	160	6 ½	4.0	2.8	2.0	1.6	170		5
27347	160	6 ½	4.0	2.8	2.0	1.6	170	x	5
26742	180	7	4.0	3.0	2.5	1.8	220		5
27348	180	7	4.0	3.0	2.5	1.8	220	x	5

**Z 16 0 01****Classic heavy-duty diagonal cutters.**

Standards: DIN ISO 5749.

Head shape: Semi-circular.

Design: Low wear lap joint, riveted and able to withstand high levels of load.

The Wiha DynamicJoint® ensures optimal transmission of hand strength to the cutting edges.

Lightweight action, clean cutting achieved by specially milled precision cutting edges.

Long term cutting is achieved through additional inductive hardening to approx. 64 HRC.

Material: High quality C 70 tool steel, specially tempered.

Application: Power-assisted all-round diagonal cutter for cutting soft to extremely hard wires and cables.

Order-No.	mm	II	○	●	●	g	SB	
26746	160	6 ½	3.5	2.5	2.0	160		5
27349	160	6 ½	3.5	2.5	2.0	160	x	5
26749	180	7	3.8	2.7	2.3	220		5
27370	180	7	3.8	2.7	2.3	220	x	5
26752	200	8	4.2	3.0	2.5	275		5
27371	200	8	4.2	3.0	2.5	275	x	5

**Diagonal cutters and cable cutters.****NEW****Z 18 0 01****BiCut Classic - switchable high-performance diagonal cutters.**

Standards: Based on DIN ISO 5749.

Head shape: Semi-circular.

Design: Clever - BiCut does the job of two pairs of pliers.

Powerful - Up to 50% less hand strength required for cutting.

Power - Cutting force doubled for extremely hard materials.

Comfortable - Easily switch between the two strengths in a one handed operation.

Robust and durable - Cutter blades induction hardened up to 64 HRC.

Material: Hard as steel - Drop forged of high-quality C70 steel.

Application: For cutting various materials from soft to extremely hard, such as cables, nails, screws, bolts, wire cable, spring wire, chains, etc.

Order-No.	mm	II	○	●	g	SB	
38060	200	8	3.5	3	310		5
38981	200	8	3.5	3	310	x	5

**Z 50 1 01****Classic cable cutter pliers.**

Head shape: Classic cutting form.

Design: Light, energy-saving and clean cutting with specially ground precision cutting edges.

Durable cutting edges due to additional induction hardening to approx. 58 HRC.

Safety stop prevents finger injuries after cutting.

Material: High quality C 70 tool steel, tempered.

Application: Cable cutter for cutting of copper and aluminium cables without crushing, also suitable for stripping.

Not for steel cable, wires and copper conductors with hard coatings.

Order-No.	mm	II	Ø	mm²	g	SB	
34729	160	6 ½	16	50	150		5
36217	160	6 ½	16	50	150	x	5
34730	200	8	20	60	270		5
36981	200	8	20	60	270	x	5

**Wiha Info**

**Wiha BiCut - Double the power at the press of a button**

- **Clever:**  
BiCut does the job of two pairs of pliers.
- **Power:**  
Cutting force doubled for extremely hard materials.
- **Powerful:**  
Up to 50% less hand strength required for cutting.





# Wiha Classic.

The complete workshop range.

## TriCut. Stripping pliers.



**NEW**

### Z 14 1 01 Classic TriCut installation pliers.

**Head shape:** With three processing stations: For cutting and stripping.  
**Design:** Low wear lap joint, riveted and able to withstand high loads. Diagonal cutters with durable cutting edges due to additional induction hardening to approx. 64 HRC. Ergonomic and energy-saving stripping lengthwise on the cable and the pliers, thanks to the specially cranked head. Two precision stripping stations for conduction with 1.5 mm<sup>2</sup> and 2.5 mm<sup>2</sup>.  
**Material:** High quality C 70 tool steel, tempered.  
**Application:** Diagonal cutters for cutting soft and hard wires, as well as cables such as NYM lines 3x1.52 - 5x2.52. Flush stripping of round and damp-proof cable and stripping of conductors, even in hard-to-reach areas, e.g. in junction boxes and distribution boxes.

Order-No.	mm	II	○	●	●	g	SB	
38627	170	7	4	2.5	1.6	230		5
38854	170	7	4	2.5	1.6	230	x	5

## Crimping pliers. Precision mechanic's needle-nose pliers.



### Z 60 0 01 Classic crimping pliers.

**Standards:** DIN ISO 5743.  
**Head shape:** Fixed profile grooves for the relevant conductor cross-sections.  
**Design:** Trapezoidal or semi-circular profiles for a secure connection between end sleeve and conductor. Sleeve and conductor inserted from the side.  
**Material:** High-quality tool steel, tempered.  
**Application:** For crimping end sleeves acc. to DIN 46228 parts 1 + 4.

Order-No.	mm	II	mm <sup>2</sup>	g	
28330	145	5 ¼	0,25-2,5	130	5
30066	180	7	0,25-16	250	5



### Z 55 0 01 Classic stripping pliers.

**Standards:** DIN ISO 5743.  
**Head shape:** Precision cutting edge prism for even cutting of cable insulation.  
**Design:** An easy to use adjusting screw allows the stripping diameter to be set. Opening spring for effortless and sensitive handling of pliers.  
**Material:** High quality C 70 tool steel, tempered.  
**Application:** Simple stripping of cables and strands of up to ø 5 mm/ 10 mm<sup>2</sup> conductor cross-section.

Order-No.	mm	II	Ø	mm <sup>2</sup>	g	SB	
26845	160	6 ½	5	10	125		5
27368	160	6 ½	5	10	125	x	5



### Z 36 0 01 Precision mechanic's needle nose pliers with cutting edge and spring.

**Standards:** DIN ISO 5745.  
**Head shape:** Straight shape.  
**Design:** Gripping surfaces partially serrated in parts. Cutting edges additionally induction hardened to approx. 64 HRC. With spring and opening limit for effortless, sensitive working.  
**Material:** High quality C 70 tool steel, tempered.  
**Application:** Grip and hold as well as cut soft and hard wires and cables, popular for precision mechanics and model-making applications.

Order-No.	mm	II	○	●	g	
36483	160	6 ½	2	1.2	95	5

#### Details of cutting results of cutting pliers.

Symbol/Types of wire	Example	Tensile strength ca. N/mm <sup>2</sup>
○ <b>Soft wire</b>	Copper, aluminium	220 - 250
● <b>Medium hard wire</b>	Iron nail	750 - 800
● <b>Hard wire</b>	Spring wire, steel nails	1.600 - 1.800
● <b>Piano wire</b>	Hardened spring steel	2.200 - 2.300

Test wires standardised in DIN ISO 5744



**Safety note:**

When working with cutting pliers –  
beware of wire ends flying away.  
Please wear safety glasses.

**Precision mechanic's diagonal cutters.****Z 44 3 01** Classic precision mechanic's diagonal cutters with spring.

Standards: DIN ISO 5749.  
Head shape: Semi-circular, swedish style.  
Design: Low wear lap joint, riveted and able to withstand high loads.  
Lightweight action, clean cutting achieved by specially milled precision cutting edges.  
Long term cutting is achieved through additional inductive hardening to approx. 64 HRC.  
With spring and opening limit for effortless, sensitive working.  
Material: High quality C 70 tool steel, tempered.  
Application: For almost flush cutting of soft and semi-hard wires.

Order-No.	mm	II	○	○	↺ g	▬
36189	125	5	2	0.8	65	5

**NEW****Z 15 0 01** Classic diagonal cutters for plastic.

Standards: DIN ISO 5743.  
Head shape: Semi-circular, swedish style.  
Design: Low wear lap joint, riveted and able to withstand high loads.  
Precision cutting edge with surface-ground cutting surface and cutting edge without facet.  
For flush, clean cuts.  
Opening spring for effortless and sensitive handling of pliers.  
Material: High quality C 70 tool steel, tempered.  
Application: ideal for smooth cutting of plastic parts or soft materials.

Order-No.	mm	II	↺ g	▬
37402	125	5	70	5
37403	160	6 ½	165	5

**Monier pliers (rabitz pliers).****Z 07 0 01** Classic long flat-nose pliers.

Standards: DIN ISO 5745.  
Head shape: Extra long head.  
Design: Ridged gripping surfaces.  
Material: High-quality tool steel, tempered.  
Application: Gripping and right-angled bending of wires and sheet metal parts.

Order-No.	mm	II	↺ g	SB	▬
26730	160	6 ½	130		5
27344	160	6 ½	130	x	5

**Z 09 0 01** Classic long round-nose pliers.

Standards: DIN ISO 5745.  
Head shape: Extra long head.  
Design: Ridged gripping surfaces.  
Material: High-quality tool steel, tempered.  
Application: Gripping and bending of wires and sheet metal parts.

Order-No.	mm	II	↺ g	SB	▬
26733	160	6 ½	110		5
27345	160	6 ½	110	x	5

**Wiha Info**

Due to their moving component and their partly blank steel components, pliers require a certain amount of care:

Therefore keep the pliers joints as clean as possible and lubricate them and the blank surfaces with a drop of thin, acid-free and resin-free oil:

This ensures you can enjoy your Wiha quality pliers for a long time.

# Wiha Classic.

The complete workshop range.

## Water pump pliers.



### Z 21 0 01 Classic water pump pliers, box type.

Standards: DIN ISO 8976.  
 Head shape: Narrow head, therefore also appropriate for work in small spaces.  
 Design: Precision adjustment joint, box type, providing optimum adaptation to object to be gripped.  
 Long durability achieved by additional inductive hardening of gripper jaws.  
 Material: High quality chrome-vanadium molybdenum steel, tempered.  
 Application: For gripping and holding pipes and angular profiles such as hex nuts in the installation area.

Order-No.	mm	II	○	⊕	↔	SB	
26760	180	7	1	30	145		5
27350	180	7	1	30	145	x	5
26761	250	10	2	50	345		5
27381	250	10	2	50	345	x	5
26763	300	12	2 ½	63	555		5
27382	300	12	2 ½	63	555	x	5

## Water pump pliers.



### Z 23 1 01 QuickFix Classic water pump pliers, box type.

Standards: DIN ISO 8976.  
 Head shape: Narrow head, therefore also appropriate for work in small spaces.  
 Design: Fast and easy-to-adjust water pump pliers, with automatic adjustment of the box type, precision-stepped joint. Optimum adjustment to the object to be gripped.  
 Long durability achieved by additional inductive hardening of gripper jaws.  
 Material: Chrome-vanadium molybdenum steel, tempered.  
 Application: For rapid and optimum gripping and holding of pipes and angular profiles such as hex nuts in the installation area.

Order-No.	mm	II	○	⊕	↔	SB	
39091	250	10	1 ½	40	360		5
39094	250	10	1 ½	40	360	x	1

Available from September 2014



### Z 22 0 01 Classic water pump pliers with push button adjustment.

Standards: DIN ISO 8976.  
 Head shape: Extra narrow head, therefore also appropriate for work in difficult to access areas.  
 Design: Precision adjustment joint, box type, providing optimum adaptation to object to be gripped.  
 Rapid and simple push button setting and locking.  
 Long durability achieved by additional inductive hardening of gripper jaws.  
 Material: High quality chrome-vanadium molybdenum steel, tempered.  
 Application: For gripping and holding pipes and angular profiles such as hex nuts in the installation area.

Order-No.	mm	II	○	⊕	↔	SB	
26764	180	7	1	30	150		5
27351	180	7	1	30	150	x	5
26765	250	10	2	50	365		5
27383	250	10	2	50	365	x	5
26767	300	12	2 ½	63	570		5
27384	300	12	2 ½	63	570	x	5

### Opening width of water pump pliers.

⊕: Maximum gripper width across flats [mm]  
 ○: Maximum gripper pipe diameter [°]

**Safety note:**

When working with cutting pliers – beware of wire ends flying away. Please wear safety glasses.

**End cutting nippers and pincers.****Z 17 0 01** Classic heavy-duty end cutting nippers.

Standards: DIN ISO 5748.

Head shape: Classic style.

Design: Low wear lap joint, riveted and able to withstand high levels of load. Striking high quality cutting edge with high cutting performance and low application of force due to highly precise processing. Good durability due to additional induction hardening of cutting edges to approx. 64 HRC.

Material: High quality C 70 tool steel, tempered.

Application: Power assisted, all round diagonal cutter for soft wires as well as demanding piano wires.

Also appropriate for binding (plaiting) and cutting wire netting in reinforced concrete structures.

Order-No.	mm	II	○	●	●	g	SB	
26757	160	6 ½	3.5	2.5	1.6	180		5
27372	160	6 ½	3.5	2.5	1.6	180	x	1
26758	180	7	3.8	2.8	1.8	200		5
27373	180	7	3.8	2.8	1.8	200	x	5
26759	200	8	4.0	3.0	2.0	220		5
27374	200	8	4.0	3.0	2.0	220	x	5

**Z 30 0 01** Classic pincers (grip, edge pliers).

Standards: DIN ISO 9243.

Head shape: Classic style.

Design: Low wear lap joint, riveted and able to withstand high levels of load. Striking high quality cutting edge with high cutting performance and low application of force due to highly precise processing. Good durability due to additional induction hardening of cutting edges to approx. 64 HRC.

Material: High quality C 70 tool steel, tempered.

Application: For withdrawing and cutting nails and wire pins.

Order-No.	mm	II	○	g	SB	
26771	180	7	2.0	265		5
27375	180	7	2.0	265	x	5
26772	200	8	2.2	350		5
27376	200	8	2.2	350	x	5

**Monier pliers (rabitz pliers)****Z 31 0 01** Classic Monier pliers (rabitz pliers).

Standards: DIN ISO 9242.

Head shape: Classic style.

Design: Low wear lap joint, riveted and able to withstand high levels of load. High quality cutting edge with high cutting performance and low application of force due to highly precise processing. Good durability due to additional induction hardening of cutting edges to approx. 64 HRC.

Material: High quality C 70 tool steel, tempered.

Application: For binding (plaiting) and cutting wire netting in reinforced concrete structures in a single operation.

Order-No.	mm	II	○	●	●	g	SB	
26774	220	8 ¾	3.2	2.0	1.6	360		5
27377	220	8 ¾	3.2	2.0	1.6	360	x	5
26776	250	10	3.5	2.2	1.8	425		5
27378	250	10	3.5	2.2	1.8	425	x	5
26778	280	11	3.8	2.4	2.0	460		5
27379	280	11	3.8	2.4	2.0	460	x	5
26780	300	12	3.8	2.4	2.0	485		5
27380	300	12	3.8	2.4	2.0	485	x	5

**Z 31 0 00** Classic Monier pliers (rabitz pliers).

Standards: DIN ISO 9242.

Head shape: Classic style.

Design: High quality cutting edge with high cutting performance and low application of force due to highly precise processing. Good durability due to additional induction hardening of cutting edges to approx. 64 HRC.

Material: High quality C 70 tool steel, tempered.

Application: For binding (plaiting) and cutting wire netting in reinforced concrete structures in a single operation.

Order-No.	mm	II	○	●	●	g	SB	
26773	220	8 ¾	3.2	2.0	1.6	350		5
27501	220	8 ¾	3.2	2.0	1.6	350	x	5
26775	250	10	3.5	2.2	1.8	415		5
27502	250	10	3.5	2.2	1.8	410	x	5
26777	280	11	3.8	2.4	2.0	450		5
27503	280	11	3.8	2.4	2.0	450	x	5
26779	300	12	3.8	2.4	2.0	475		5
27504	300	12	3.8	2.4	2.0	475	x	5

# Wiha Classic.

The complete workshop range.

## Circlip pliers for bores (internal).



### Z 33 0 01 Classic circlip pliers for inner rings (bores).

Standards: DIN ISO 5256.  
 Head shape: Straight shape.  
 Design: Drop forged, cylindrical precision tips.  
 Material: High quality chrome-vanadium molybdenum steel.  
 Application: For inserting / removing circlips from inside bores.

Order-No.	Typ	mm	II	☺	↕	SB	☑
26781	J 0	139	5 ½	8-13	95		5
27352	J 0	139	5 ½	8-13	95	x	5
26782	J 1	140	5 ½	12-25	95		5
27353	J 1	140	5 ½	12-25	95	x	5
26783	J 2	180	7	19-60	155		5
27354	J 2	180	7	19-60	155	x	5
26784	J 3	225	9	40-100	245		5
27355	J 3	225	9	40-100	245	x	5
29425	J 4	310	12	85-140	410		5

## Circlip pliers for shafts (external).



### Z 34 0 01 Classic circlip pliers for outer rings (shafts).

Standards: DIN ISO 5254.  
 Head shape: Straight shape.  
 Design: Drop forged, cylindrical precision tips.  
 Material: High quality chrome-vanadium molybdenum steel.  
 Application: For fitting / removing circlips externally to / from shafts or axles.

Order-No.	Typ	mm	II	☺	↕	SB	☑
26789	A 0	139	5 ½	3-10	90		5
27360	A 0	139	5 ½	3-10	90	x	5
26790	A 1	140	5 ½	10-25	90		5
27361	A 1	140	5 ½	10-25	90	x	5
26791	A 2	180	7	19-60	155		5
27362	A 2	180	7	19-60	155	x	5
26792	A 3	225	9	40-100	260		5
27363	A 3	225	9	40-100	260	x	5
29428	A 4	310	12	85-140	455		5



### Z 33 1 01 Classic circlip pliers for inner rings (bores).

Standards: DIN ISO 5256.  
 Head shape: Angled form.  
 Design: Drop forged, cylindrical precision tips.  
 Material: High quality chrome-vanadium molybdenum steel.  
 Application: For inserting / removing circlips from inside bores.

Order-No.	Typ	mm	II	☺	↕	SB	☑
26785	J 01	139	5 ½	8-13	95		5
27356	J 01	139	5 ½	8-13	95	x	5
26786	J 11	140	5 ½	12-25	95		5
27357	J 11	140	5 ½	12-25	95	x	5
26787	J 21	180	7	19-60	155		5
27358	J 21	180	7	19-60	155	x	5
26788	J 31	225	9	40-100	245		5
27359	J 31	225	9	40-100	245	x	5
29427	J 41	310	12	85-140	410		5



### Z 34 1 01 Classic circlip pliers for outer rings (shafts).

Standards: DIN ISO 5254.  
 Head shape: Angled form.  
 Design: Drop forged, cylindrical precision tips.  
 Material: High quality chrome-vanadium molybdenum steel.  
 Application: For fitting / removing circlips externally to / from shafts or axles.

Order-No.	Typ	mm	II	☺	↕	SB	☑
26794	A 01	139	5 ½	3-10	90		5
27364	A 01	139	5 ½	3-10	90	x	5
26795	A 11	140	5 ½	10-25	90		5
27365	A 11	140	5 ½	10-25	90	x	5
26796	A 21	180	7	19-60	155		5
27366	A 21	180	7	19-60	155	x	5
26797	A 31	225	9	40-100	260		5
27367	A 31	225	9	40-100	260	x	5
29429	A 41	310	12	85-140	455		5

## Circlip pliers for bores (internal).



Z 33 4 01

Classic circlip pliers for inner rings (bores).  
With Wiha MagicTips®.

Standards: DIN ISO 5256.

Head shape: Straight shape.

Design: Wiha MagicTips® – highly resilient precision tips manufactured from best ball-bearing steel.

With special surface finish to protect against rust and with a unique latching function (from size 2) that effectively prevents jumping away of the safety rings.

High wear resistance with additional hardening of tips.

Slim plier head for optimal access and a good view of the workpiece.

Material: High quality chrome-vanadium molybdenum steel, tempered.

Application: For inserting / removing circlips from inside bores.

Order-No.	Typ	mm	II	☺	↕	SB	☑
34688	J 0	140	5 ½	8-13	95		5
36975	J 0	140	5 ½	8-13	95	x	5
34689	J 1	140	5 ½	12-25	95		5
36225	J 1•	140	5 ½	12-25	95	x	5
34690	J 2•	180	7	19-60	155		5
36222	J 2•	180	7	19-60	155	x	5
34691	J 3•	220	9	40-100	245		5
36272	J 3•	220	9	40-100	245	x	5
34692	J 4•	305	12	85-140	410		5

• with safety latching function

## Circlip pliers for bores (internal).



Z 33 5 01

Classic circlip pliers for inner rings (bores).  
With Wiha MagicTips®.

Standards: DIN ISO 5256.

Head shape: Angled form.

Design: Wiha MagicTips® – highly resilient precision tips manufactured from best ball-bearing steel.

With special surface finish to protect against rust and with a unique latching function (from size 21) that effectively prevents jumping away of the safety rings.

High wear resistance with additional hardening of tips.

Slim plier head for optimal access and a good view of the workpiece.

Material: High quality chrome-vanadium molybdenum steel, tempered.

Application: For inserting / removing circlips from inside bores.

Order-No.	Typ	mm	II	☺	↕	SB	☑
34693	J 01	140	5 ½	8-13	95		5
36976	J 01	140	5 ½	8-13	95	x	5
34694	J 11	140	5 ½	12-25	95		5
36223	J 11	140	5 ½	12-25	95	x	5
34695	J 21•	180	7	19-60	155		5
36224	J 21•	180	7	19-60	155	x	5
34696	J 31•	220	9	40-100	245		5
36226	J 31•	220	9	40-100	245	x	5
34697	J 41•	305	12	85-140	410		5

• with safety latching function

## Wiha Info



Wiha MagicTips® –  
Top of their class

- **Maximum grip:** The special latching function preventing jumping away of the safety rings makes the Wiha circlip pliers truly unique
- **Hard as steel:** Additional hardening of tips means high wear resistance and therefore excellent durability
- **Precise:** Precision tips of high performance steel for maximum grip and high stability





# Wiha Classic.

The complete workshop range.

## Circlip pliers for shafts (external).



**Z 34 4 01** Classic circlip pliers for outer rings (shafts).  
With Wiha MagicTips®.

Standards: DIN ISO 5254.  
Head shape: Straight shape.  
Design: Wiha MagicTips® – highly resilient precision tips manufactured from best ball-bearing steel.  
With special surface finish to protect against rust and with a unique latching function (from size 2) that effectively prevents jumping away of the safety rings.  
High wear resistance with additional hardening of tips.  
Slim plier head for optimal access and a good view of the workpiece.  
Spring protected in the joint, cannot be lost.  
Material: High quality chrome-vanadium molybdenum steel, tempered.  
Application: For fitting / removing circlips externally to / from shafts or axles.

Order-No.	Typ	mm	II	⊖	↺	↻	SB	SB
34698	A 0	140	5 ½	7-10	90			5
36977	A 0	140	5 ½	7-10	90	x		5
34699	A 1	140	5 ½	10-25	90			5
36978	A 1	140	5 ½	10-25	90	x		5
34700	A 2•	185	7	19-60	155			5
36220	A 2•	185	7	19-60	155	x		5
34701	A 3•	240	9	40-100	260			5
36219	A 3•	240	9	40-100	260	x		5
34702	A 4•	300	12	85-140	455			5

• with safety latching function

## Circlip pliers for shafts (external).



**Z 34 5 01** Classic circlip pliers for outer rings (shafts).  
With Wiha MagicTips®.

Standards: DIN ISO 5254.  
Head shape: Angled form.  
Design: Wiha MagicTips® – highly resilient precision tips manufactured from best ball-bearing steel.  
With special surface finish to protect against rust and with a unique latching function (from size 21) that effectively prevents jumping away of the safety rings.  
High wear resistance with additional hardening of tips.  
Slim plier head for optimal access and a good view of the workpiece.  
Spring protected in the joint, cannot be lost.  
Material: High quality chrome-vanadium molybdenum steel, tempered.  
Application: For fitting / removing circlips externally to / from shafts or axles.

Order-No.	Typ	mm	II	⊖	↺	↻	SB	SB
34703	A 01	140	5 ½	7-10	90			5
36979	A 01	140	5 ½	7-10	90	x		5
34704	A 11	140	5 ½	10-25	90			5
36980	A 11	140	5 ½	10-25	90	x		5
34705	A 21•	185	7	19-60	155			5
36218	A 21•	185	7	19-60	155	x		5
34706	A 31•	240	9	40-100	260			5
36221	A 31•	240	9	40-100	260	x		5
34707	A 41•	300	12	85-140	455			5

• with safety latching function



### Wiha MagicTips® – Top of their class

- **Maximum grip:** The special latching function preventing jumping away of the safety rings makes the Wiha circlip pliers truly unique
- **Hard as steel:** Additional hardening of tips means high wear resistance and therefore excellent durability
- **Precise:** Precision tips of high performance steel for maximum grip and high stability

## Pliers set.

**Z 99 0 007 01** Classic Circlip pliers set, 4 pcs.

**Design:** Wiha MagicTips® – highly resilient precision tips manufactured from best ball-bearing steel.

High wear resistance with additional hardening of tips.

Slim plier head for optimal access and a good view of the workpiece.

Weight 650 g.

**Application:** Set of pliers as basic set of tools for attaching retaining rings to and removing them from shafts and boreholes.

Order-No.	Series	
34708	Z 99 0 007 01	1
	Z 33 4 01	J1, Classic circlip pliers for inner rings (bores). with Wiha MagicTips
	Z 33 4 01	J2, Classic circlip pliers for inner rings (bores). with Wiha MagicTips
	Z 34 4 01	J1, Classic circlip pliers for outer rings (shafts). with Wiha MagicTips
	Z 34 4 01	J2, Classic circlip pliers for outer rings (shafts). with Wiha MagicTips

## Display.

**Z 99 0 005 01VH** MagicTips® pliers display, 30 pcs.

**Design:** Pliers of high quality tool steel, hardened and polished.

Wiha MagicTips® – highly resilient precision tips manufactured from best ball-bearing steel.

With special surface finish to protect against rust and with a unique latching function (from size 2) that effectively prevents jumping away of the safety rings.

High wear resistance with additional hardening of tips.

Size 33.5 x 20 x 40 cm (WxDxH).

Weight 6.95 kg.

**Application:** The pliers selection for common demands when applying and removing safety rings to shafts and in bores.

Order-No.	Series	
36064	Z 99 0 005 01VH	1
	Z 33 4 01	Classic circlip pliers for inner rings (bores). 3x J 1 mm 140" 3x J 2 mm 180" 3x J 3 mm 220"
	Z 33 5 01	Classic circlip pliers for inner rings (bores). 3x J 11 mm 140" 3x J 21 mm 180" 3x J 31 mm 220"
	Z 34 4 01	Classic circlip pliers for outer rings (shafts). 3x A 2 mm 185" 3x A 3 mm 240"
	Z 34 5 01	Classic circlip pliers for outer rings (shafts). 3x A21 mm 185" 3x A 31 mm 240"



# Wiha Classic.

The complete workshop range.

## Pipe wrenches swedish style.



### Z 26 0 00 Classic corner pipe pliers, S-jaw.

Standards: DIN 5234.  
 Head shape: S-jaw shape angled 45°.  
 Design: Self-clamping gripping of pipes and hex nuts at 3 points.  
 Torsion-free handle profile.  
 Adjusting nut secured to prevent loss.  
 Long durability achieved by additional inductive hardening of gripper jaws.  
 Material: Chrome-vanadium steel, tempered.  
 Application: Safe and secure grip on pipes and hex nuts.

Order-No.	mm	⊘	⊘	g	mm
29435	320	1	0-40	750	1
29436	420	1 ½	0-55	1350	1
29437	535	2	0-67	2450	1



### Z 26 1 00 Classic corner pipe pliers, 45°.

Standards: DIN 5234.  
 Head shape: Swedish shape angled 45°.  
 Design: Safe and secure grip due to teeth that are offset against the direction of rotation.  
 Torsion-free handle profile.  
 Adjusting nut secured to prevent loss.  
 Long durability achieved by additional inductive hardening of gripper jaws.  
 Material: Chrome-vanadium steel, tempered.  
 Application: Safe and secure grip on pipes, flat workpieces and nuts.

Order-No.	mm	⊘	⊘	g	mm
29438	315	1	0-40	750	1
29439	420	1 ½	0-55	1240	1
29440	570	2	0-67	2500	1

## Corner pipe pliers. Grip pliers.



### Z 26 2 00 Classic corner pipe pliers, 90°.

Standards: DIN 5234.  
 Head shape: Swedish shape angled 90°.  
 Design: Safe and secure grip due to teeth that are offset against the direction of rotation.  
 Torsion-free handle profile.  
 Adjusting nut secured to prevent loss.  
 Long durability achieved by additional inductive hardening of gripper jaws.  
 Material: Chrome-vanadium steel, tempered.  
 Application: Safe and secure grip on pipes, flat workpieces and nuts.

Order-No.	mm	⊘	⊘	g	mm
29441	320	1	0-40	750	1
29442	415	1 ½	0-55	1250	1
29443	555	2	0-67	2450	1



### Z 66 0 00 Classic grip pliers with wire cutter.

Head shape: Bent gripper jaws with wire cutter.  
 Design: Single-handed operation with quick-release lever, adjusting screw and integrated wire cutter.  
 Material: Forged jaws made of chrome-vanadium-steel.  
 Body of pliers made of high-resistance special steel, nickel-plated.  
 Application: Clamping and gripping of round and flat material.  
 Wire cutter for cutting welded wires.

Order-No.	mm	mm	⊘	⊘	g	mm
29485	180	7	8-30	0-20	360	5
29486	250	10	8-40	0-20	530	5
29487	300	12	8-65	0-30	1000	5

#### Dimensions.

- ⊘: Maximum gripper width across flats
- ⊘: Maximum gripper pipe diameter
- ⊘: Opening width, flat
- ⊘: Clamping range
- ⊘: Retaining ring, external
- ⊘: Retaining ring, internal

**Safety note:**

When working with cutting pliers – beware of wire ends flying away. Please wear safety glasses.

**Pliers sets.****Z 99 0 001 01 Classic pliers set, 3 pcs.**

**Design:** All pliers made of high-quality tool steel, hardened. Head of pliers polished several times and non-slip, oil- and solvent-resistant handle coating.

Weight 630 g.

**Application:** Standard set of pliers for the basic set of tools.

Order-No.	Series	
26850	Z 99 0 001 01	1
	Z 01 0 01	Combination pliers, 180 mm with Wiha DynamicJoint and OptiGrip
	Z 12 0 01	Diagonal cutters, 160 mm with Wiha DynamicJoint
	Z 05 0 01	Needle nose pliers, 180 mm

**Pliers set.****Z 99 0 004 01 Zangensatz Classic Circlip, 4-tlg.**

**Design:** All pliers in proven Classic quality. Particularly precise tips due to high-speed turning, cylindrical with defined flat cone point. Tightened with great dimensional accuracy and not subsequently curved. Weight 680 g.

**Application:** Set of pliers as basic set of tools for attaching retaining rings to and removing them from shafts and boreholes.

Best.-Nr.	Series	
26793	Z 99 0 004 01	1
	Z 33 0 01	J1, Circlip pliers for bores,
	Z 33 0 01	J2, Circlip pliers for bores,
	Z 34 0 01	A1, Circlip pliers for shafts,
	Z 34 0 01	A2, Circlip pliers for shafts,

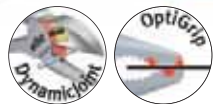
**Z 99 0 002 01 Classic Plus pliers set, 3 pcs.**

**Design:** All pliers in proven Classic quality. Cutting pliers also suitable for piano wire. QuickFix water pump pliers with "automatic" rapid adjustment. Weight 1025 g.

**Application:** Power-assisted set of pliers as part of basic set of tools.

Order-No.	Series	
26853	Z 99 0 002 01	1
	Z 02 0 01	High leverage combination pliers, 200 mm with Wiha DynamicJoint and OptiGrip
	Z 16 0 01	High leverage diagonal cutters, 180 mm with Wiha DynamicJoint
	Z 23 1 01	QuickFix water pump pliers, 250 mm



# Wiha Electronic.

Precision for made-to-measure work.

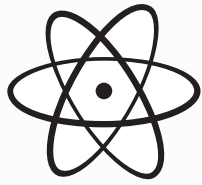

Arms made of soft, non-slip elastomer are gentle on the parts of the hand that are sensitive to pressure

The robust, ergonomic handle is carefully fixed to the pliers

Hard, comfortable elastomer zones ensure low friction in the movement range of the fingers

Glare free gunmetal finish

Harmonious design of the front part of the handle for an optimum finger hold

Precision ground cutting edges

A calm hand is essential for working with electronic components. The Wiha Electronic pliers optimally support the user in this respect.

The sophisticated details are conspicuous: ground, razor-sharp cutting edges for smooth cuts. A handle shape that correctly positions the hand of the user. A glare-free, finely pressed pliers head for precise, safe grasping and cutting.

And all with an excellent quality and at a competitive price to which both professionals and demanding handymen will not be able to say no to.



The Electronic long-nose pliers from Wiha hold small components and bend wires.



**Wiha Electronic.**

- **Specially for fine work**  
Glare-free, phosphate coated head, applied precision joint
- **Precise**  
Precisely ground cutting edges
- **As hard as steel**  
Finely pressed from high grade C70 steel
- **Robust and durable**  
Cutting edges are additionally hardened up to 63 HRC
- **Sensitive**  
Greater control with grasping via opening spring with fine resistance
- **Ergonomic**  
An innovative handle shape for optimal handling

#### Details of cutting results of cutting pliers.

Symbol/Types of wire	Example	Tensile strength ca. N/mm <sup>2</sup>
○ Soft wire	Copper, aluminium	220 - 250
◐ Medium hard wire	Iron nail	750 - 800
● Hard wire	Spring wire, steel nails	1.600 - 1.800
● Piano wire	Hardened spring steel	2.200 - 2.300

Test wires standardised in DIN ISO 5744



**Safety note:**

When working with cutting pliers –  
beware of wire ends flying away.  
Please wear safety glasses.

**Diagonal cutters, wide shape.****Z 41 1 03 Diagonal cutters Electronic.**

Head shape: Wide, pointed head.  
Design: Cutting edge with full flush cutter function.  
With opening spring.  
Material: C 70 special tool steel.  
Application: For an absolutely flush cut of soft wires in the electronics industry.

Order-No.	mm	II	○	g	SB	
26818	138	5 ½	1.3	70		5
27391	138	5 ½	1.3	70	x	5

**Diagonal cutters, narrow shape.****Z 40 0 03 Micro diagonal cutter Electronic.**

Head shape: Extra narrow, short head for working in particularly restricted spaces.  
Design: Cutting edge with full flush cutter function.  
With opening spring.  
Material: C 70 special tool steel.  
Application: For absolutely flush cutting of soft wires in places which are difficult to access in the electronics industry.

Order-No.	mm	II	○	g	SB	
26812	118	4 ½	0.8	60		5
27388	118	4 ½	0.8	60	x	5

**Z 41 3 03 Diagonal cutters Electronic.**

Standards: DIN ISO 9654.  
Head shape: Wide, pointed head.  
Design: Cutting edge with semi-flush cutter function, thus also appropriate for medium hard wires. Strong design for soft wires up to  $\varnothing$  2.0 mm.  
With opening spring.  
Material: C 70 special tool steel.  
Cutting edges > 60 HRC.  
Application: Universal small diagonal cutter for cutting soft and medium hard wires in the electronics and precision mechanical engineering industries.

Order-No.	mm	II	○	○	g	SB	
26815	138	5 ½	2.0	0.8	80		5
27393	138	5 ½	2.0	0.8	80	x	5

**Z 40 1 03 Diagonal cutters Electronic with wire trapping spring.**

Head shape: Narrow, pointed head.  
Design: Cutting edge with full flush cutter function.  
With opening spring and fixture for collecting ends of wires that have been cut off.  
Material: C 70 special tool steel.  
Application: For absolutely flush cutting of soft wires in places which are difficult to access in the electronics industry.

Order-No.	mm	II	○	g	SB	
26813	128	5	1.0	70		5
27390	128	5	1.0	70	x	5

**Z 41 6 03 Diagonal cutters Electronic with wire trapping spring.**

Head shape: Wide, pointed head.  
Design: Cutting edge with full flush cutter function.  
With opening spring and fixture for collecting ends of wires that have been cut off.  
Material: C 70 special tool steel.  
Cutting edges approx. 56 HRC.  
Application: For an absolutely flush cut of soft wires in the electronics industry.

Order-No.	mm	II	○	g	SB	
26825	138	5 ½	1.3	80		5
27395	138	5 ½	1.3	80	x	5

**Wiha Info**

Electronics pliers with cutting edges are designed especially for cutting soft to medium hard wires.

The diameters of materials which your electronics pliers are able to cut depend not only on the material selected and the hardness of the cutting edges but also depend greatly on the geometry of the cutting edges:

- Pliers with the full flush cutter function may cut off wires smoothly and flushly but are only appropriate for soft copper wires (99.85% pure copper)
- Pliers with the semi-flush and normal bevelled cutting edges function on the other hand may not cut in a totally flush manner but can cut thin iron wires or even medium hard steel wire
- You will find details of precise cutting results in the individual figures of pliers

# Wiha Electronic.

Precision for made-to-measure work.

## Diagonal cutters.



### Z 46 0 03 Oblique cutting nippers Electronic.

Head shape: Wide, pointed head.  
 Design: Cutting edge with full flush cutter function. With cutting edge at 48° for cutting obliquely from above or from the side.  
 Material: C 70 special tool steel.  
 Application: For absolutely flush cutting of soft wires in places which are difficult to access in the electronics industry.

Order-No.	mm		○	g	SB	■
26833	138	5 ½	1.3	70		5
27398	138	5 ½	1.3	70	x	5



### Z 46 0 03 Micro oblique cutting nippers Electronic.

Head shape: Extremely narrow, short head for working in particularly restricted spaces.  
 Design: Cutting edge with full flush cutter function. Edge at 30° to face end of pliers for cutting obliquely from above or from the side.  
 Material: C 70 special tool steel.  
 Application: For absolutely flush cutting of soft wires in places which are difficult to access in the electronics industry.

Order-No.	mm		○	g	SB	■
26830	118	4 ½	0.6	60		5
27397	118	4 ½	0.6	60	x	5

## Needle-nose pliers. Stripping pliers.



### Z 36 0 03 Pointed pliers Electronic.

Head shape: Narrow, short head.  
 Design: With plain inside jaws. Width at tip is only 1.2 mm.  
 Material: C 70 special tool steel.  
 Application: For holding small components as well as for holding and angling wires.

Order-No.	mm		g	SB	■
26801	135	5 ½	70		5
27326	135	5 ½	70	x	5



### Z 49 2 03 Electronic stripping pliers.

Head shape: Wide, long head with ridged gripping surface, shears blade and firm wire stripping stations.  
 Design: Wire stripping stations: 0.8 / 1.0 / 1.3 / 1.6 / 2.0 / 2.6 mm, AWG 20 / 18 / 16 / 14 / 12 / 10. With opening spring and locking mechanism.  
 Material: C 70 special tool steel.  
 Application: For gripping, cutting and stripping of wires with diameter.

Order-No.	mm		Ø mm	AWG	g	SB	■
33471	180	7	0.8-2.6	20-10	70		5
36794	180	7	0.8-2.6	20-10	70	x	5



### Z 49 7 03 Electronic stripping pliers.

Head shape: Wide, long head with ridged gripping surface, shears blade and firm wire stripping stations.  
 Design: Wire stripping stations: 0.4 / 0.5 / 0.6 / 0.8 / 1.0 / 1.3 mm, AWG 26 / 24 / 22 / 20 / 18 / 16. With opening spring and locking mechanism.  
 Material: C 70 special tool steel.  
 Application: For gripping, cutting and stripping of wires with diameter.

Order-No.	mm		Ø mm	AWG	g	SB	■
33472	180	7	0.4-1.3	26-16	70		5
35820	180	7	0.4-1.3	26-16	70	x	5

## Wiha Info

A variety of different pliers are required for electronics applications. Simply contact us if you require different models for other applications.



# Wiha Professional ESD.

Precise in every detail.

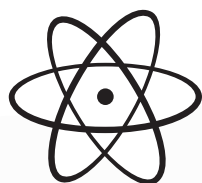

Hard, comfortable elastomer zones ensure low friction in the movement range of the fingers

The anti-static, ergonomic handle is fixed to the pliers

Double leaf spring for sensitive working

Low glare mirror polished finish

Precision box joint with long service life

Antistatic arms made of soft, non-slip elastomer are gentle on the parts of the hand that are sensitive to pressure



**Wiha Professional ESD.**

- ESD safe**  
 Suitable for work at ESD workstations in accordance with IEC 61340-5-1, surface resistance  $10^6 - 10^9$  ohms
- Anti-static**  
 Unique: all handle components are discharging (dissipative)
- Precise**  
 Box joint, resistant against twisting
- As hard as steel**  
 Pliers head drop forged from high quality steels
- Robust and durable**  
 Cutting edges are individually tempered and additionally induction hardened to approx. 64 HRC; joints are extremely wear resistant and withstand high stresses, with high-quality riveting
- Ergonomic**  
 Extra wide handle backs, with soft and hard zones perfectly distributed across the handle
- Attractive**  
 Appealing design with finely polished head

Wiha Professional ESD is ideal for electronics professionals needing precise, robust pliers.

The formula for success for the pliers series is as simple as it is clever: uncompromising sharpness and hardness for flush cutting, and pleasant comfort with the handle for firm, fatigue-free grasping, holding and cutting.



The Professional ESD diagonal cutter with a broad, pointed head cut soft wires flush.



The Professional ESD needle-nose pliers are predominantly used for fine gripping and bending work.

Suitable for work at ESD workstations in accordance with IEC 61340-5-1. Safety Notice:  
 Wiha Professional ESD pliers are noninsulated, therefore not suitable for working on live parts.

# Wiha Professional ESD.

Precise in every detail.

## Diagonal cutter, narrow, pointed shape.



### Z 40 1 04 Diagonal cutter Professional ESD.

Standards: DIN ISO 9654. IEC 61340-5-1.  
 Head shape: Narrow, pointed head.  
 Design: Bevelled cutting edges, individually tested, also appropriate for thin, hard wires. Maximum service life of cutting edge achieved through additional inductive hardening to approx. 64 HRC.  
 With opening spring. Surface resistance  $10^6 - 10^9$  ohms.  
 Material: High alloy carbon steel C 60.  
 Application: For cutting different hardnesses of wires in places which are difficult to access.

Order-No.	mm	II	○	●	⦿	↵	SB	▬
26808	115	4 ½	1.0	0.6	0.3	60		5
27442	115	4 ½	1.0	0.6	0.3	60	x	5

## Diagonal cutter, broad, pointed shape.



### Z 41 1 04 Diagonal cutter Professional ESD.

Standards: DIN ISO 9654. IEC 61340-5-1.  
 Head shape: Wide, pointed head.  
 Design: Bevelled cutting edges, also appropriate for hard wires. Maximum service life of cutting edge achieved through additional inductive hardening to approx. 64 HRC.  
 With opening spring. Surface resistance  $10^6 - 10^9$  ohms.  
 Material: High alloy carbon steel C 60.  
 Application: All round electronic diagonal cutter for cutting wires of different hardnesses.

Order-No.	mm	II	○	●	⦿	↵	SB	▬
26816	115	4 ½	1.4	1.0	0.4	60		5
27444	115	4 ½	1.4	1.0	0.4	60	x	5



### Z 40 3 04 Diagonal cutter Professional ESD.

Standards: DIN ISO 9654. IEC 61340-5-1.  
 Head shape: Narrow, pointed head.  
 Design: Blade without facet, individually inspected, suited to thin, tough wire. Maximum service life of cutting edge achieved through additional inductive hardening to approx. 64 HRC.  
 With opening spring. Surface resistance  $10^6 - 10^9$  ohms.  
 Material: High alloy carbon steel C 60.  
 Application: For absolutely flush cutting of copper wire in places which are difficult to access.

Order-No.	mm	II	○	↵	▬
33521	115	4 ½	1.0	60	5



### Z 41 3 04 Diagonal cutter Professional ESD.

Standards: DIN ISO 9654. IEC 61340-5-1.  
 Head shape: Wide, pointed head.  
 Design: Cutting edge without bevel for absolute flush cutting. Maximum service life of cutting edge achieved through additional inductive hardening to approx. 64 HRC.  
 With opening spring. Surface resistance  $10^6 - 10^9$  ohms.  
 Material: High alloy carbon steel C 60.  
 Application: For absolutely flush cutting of copper wire.

Order-No.	mm	II	○	↵	SB	▬
26821	115	4 ½	1.0	60		5
27445	115	4 ½	1.0	60	x	5



### Z 40 4 04 Diagonal cutter Professional ESD.

Standards: DIN ISO 9654. IEC 61340-5-1.  
 Head shape: Extra narrow, short head for working in particularly restricted spaces.  
 Design: Cutting edge almost without bevel for virtually flush cutting, individually tested. Maximum service life of cutting edge achieved through additional inductive hardening to approx. 64 HRC.  
 With opening spring. Surface resistance  $10^6 - 10^9$  ohms.  
 Material: High alloy carbon steel C 60.  
 Application: For virtually flush cutting copper wire in flat places which are difficult to access.

Order-No.	mm	II	○	↵	SB	▬
26814	115	4 ½	1.0	60		5
27443	115	4 ½	1.0	60	x	5



### Z 41 4 04 Diagonal cutters Professional ESD with wire trapping spring.

Standards: DIN ISO 9654. IEC 61340-5-1.  
 Head shape: Wide, pointed head.  
 Design: With fixture for trapping ends of wires which have been cut off. Cutting edge with full flush cutter function for virtually flush cutting. Maximum service life of cutting edge achieved through additional inductive hardening to approx. 64 HRC.  
 With opening spring. Surface resistance  $10^6 - 10^9$  ohms.  
 Material: High alloy carbon steel C 60.  
 Application: For virtually flush cutting copper wire, function for trapping cut off wire.

Order-No.	mm	II	○	↵	SB	▬
26822	115	4 ½	1.2	60		5
27446	115	4 ½	1.2	60	x	5



**Safety note:**

When working with cutting pliers – beware of wire ends flying away. Please wear safety glasses.

**Diagonal cutter, semi-circular shape.****Z 43 1 04 Diagonal cutter Professional ESD.**

Standards: DIN ISO 9654. IEC 61340-5-1.

Head shape: Narrow, semi-circular head.

Design: Cutting edge with full flush cutter function for virtually flush cutting. Maximum service life of cutting edge achieved through additional inductive hardening to approx. 64 HRC.

With opening spring. Surface resistance  $10^6 - 10^9$  ohms.

Material: High alloy carbon steel C 60.

Application: For virtually flush cutting of copper wire in places which are difficult to access.

Order-No.	mm	II	○	g	SB	
26826	115	4 ½	1.2	60		5
27447	115	4 ½	1.2	60	x	5

**Oblique end cutting nippers.****Z 46 1 04 Oblique end cutting nippers Professional ESD.**

Standards: DIN ISO 9654. IEC 61340-5-1.

Head shape: Wide head, angled at 29°.

Design: Cutting edge with full flush cutter function for virtually flush cutting. Maximum service life of cutting edge achieved through additional inductive hardening to approx. 64 HRC.

With opening spring. Surface resistance  $10^6 - 10^9$  ohms.

Material: High alloy carbon steel C 60.

Application: For virtually flush cutting of soft wires. Can be used horizontally and vertically.

Order-No.	mm	II	○	g	SB	
26835	115	4 ½	1.2	78		5
27450	115	4 ½	1.2	78	x	5

**Z 44 1 04 Diagonal cutter Professional ESD.**

Standards: DIN ISO 9654. IEC 61340-5-1.

Head shape: Wide, semi-circular head.

Design: Bevelled cutting edges, also appropriate for thin, hard wires. Maximum service life of cutting edge achieved through additional inductive hardening to approx. 64 HRC.

With opening spring. Surface resistance  $10^6 - 10^9$  ohms.

Material: High alloy carbon steel C 60.

Application: All round electronic diagonal cutter for cutting wires of different hardnesses.

Order-No.	mm	II	○	○	○	g	SB	
26831	115	4 ½	1.4	1.0	0.4	60		5
27448	115	4 ½	1.4	1.0	0.4	60	x	5

**Z 46 4 04 Oblique end cutting nippers Professional ESD.**

Standards: DIN ISO 9654. IEC 61340-5-1.

Head shape: Extra narrow head.

Design: Cutting edges angled at 40°. Cutting edge with full flush cutter function for virtually flush cutting. Maximum service life of cutting edge achieved through additional inductive hardening to approx. 64 HRC.

With opening spring. Surface resistance  $10^6 - 10^9$  ohms.

Material: High alloy carbon steel C 60.

Application: For virtually flush cutting thin, soft wires in places which are particularly difficult to access.

Order-No.	mm	II	○	g	SB	
26838	110	4 ¼	0.6	42		5
27451	110	4 ¼	0.6	42	x	5

**Z 44 3 04 Diagonal cutter Professional ESD.**

Standards: DIN ISO 9654. IEC 61340-5-1.

Head shape: Wide, semi-circular head.

Design: Cutting edge with full flush cutter function for virtually flush cutting. Maximum service life of cutting edge achieved through additional inductive hardening to approx. 64 HRC.

With opening spring. Surface resistance  $10^6 - 10^9$  ohms.

Material: High alloy carbon steel C 60.

Application: For virtually flush cutting of soft wires.

Order-No.	mm	II	○	g	SB	
26832	115	4 ½	1.2	60		5
27449	115	4 ½	1.2	60	x	5



# Wiha Professional ESD.

Precise in every detail.

## High leverage end cutting pliers.



### Z 47 1 04 End cutting nippers Professional ESD.

Standards: DIN ISO 9654.  
IEC 61340-5-1.

Head shape: Extra narrow, slim shape.

Design: Cutting edge with full flush cutter function for virtually flush cutting. Maximum service life of cutting edge achieved through additional inductive hardening to approx. 64 HRC. With opening spring. Surface resistance  $10^6 - 10^9$  ohms.

Material: High alloy carbon steel C 60.

Application: For virtually flush cutting of soft wires in places which are particularly difficult to access.

Order-No.	mm	II	○	g	SB	
26839	110	4 ¼	0.6	65		5
27452	110	4 ¼	0.6	65	x	5

## Needle nose pliers.



### Z 36 0 04 Needle nose pliers Professional ESD.

Standards: DIN ISO 9655.  
IEC 61340-5-1.

Head shape: Straight head.

Design: Fine, semi-circular tips. Ridged gripping surfaces. With opening spring. Surface resistance  $10^6 - 10^9$  ohms.

Material: C 45 special tool steel, hardened and tempered.

Application: Mainly for precision gripping and bending work.

Order-No.	mm	II	A	B	D	F	g	SB	
26799	120	4 ¾	9.5	23	6.5	1.4	60		5
27329	120	4 ¾	9.5	23	6.5	1.4	60	x	5
27905	145	5 ¾	12.0	40	7.5	2.0	93		5



### Z 47 2 04 End cutting nippers Professional ESD.

Standards: DIN ISO 9654.  
IEC 61340-5-1.

Head shape: Wide head.

Design: Cutting edge with full flush cutter function for virtually flush cutting. Maximum service life of cutting edge achieved through additional inductive hardening to approx. 64 HRC. With opening spring. Surface resistance  $10^6 - 10^9$  ohms.

Material: High alloy carbon steel C 60.

Application: For frontal, virtually flush cutting of thicker, soft wires.

Order-No.	mm	II	○	g	SB	
26840	115	4 ½	1.4	65		5
27453	115	4 ½	1.4	65	x	5



### Z 36 1 04 Needle nose pliers Professional ESD.

Standards: DIN ISO 9655.  
IEC 61340-5-1.

Head shape: Angled at 45°.

Design: Fine, semi-circular tips. Smooth gripping surfaces. With opening spring. Surface resistance  $10^6 - 10^9$  ohms.

Material: C 45 special tool steel, hardened and tempered.

Application: Mainly for precision gripping and bending work.

Order-No.	mm	II	g	SB	
26802	120	4 ¾	60		5
27439	120	4 ¾	60	x	5

**Safety note:**

When working with cutting pliers – beware of wire ends flying away. Please wear safety glasses.

**Round-nose and flat-nose pliers.****Z 37 0 04 Round nose pliers Professional ESD.**

Standards: DIN ISO 9655.  
IEC 61340-5-1.

Head shape: Round, short jaws.

Design: Smooth gripping surfaces.  
With opening spring.

Surface resistance  $10^6 - 10^9$  ohms.

Material: C 45 special tool steel, hardened and tempered.

Application: Mainly for precision gripping and bending work.

Order-No.	mm	II	g	SB	
26804	120	4 ¾	60		5
27440	120	4 ¾	60	x	5

**Z 38 0 04 Flat nose pliers Professional ESD.**

Standards: DIN ISO 9655.  
IEC 61340-5-1.

Head shape: Flat, short jaws.

Design: Smooth gripping surfaces.  
With opening spring.

Surface resistance  $10^6 - 10^9$  ohms.

Material: C 45 special tool steel, hardened and tempered.

Application: Mainly for precision gripping and bending work.

Order-No.	mm	II	g	SB	
26806	120	4 ¾	60		5
27441	120	4 ¾	60	x	5

**Set combination.****Z 99 0 001 04 Professional ESD pliers set, 4 pcs.****Dissipative tools, electrostatically discharging.**

Design: ESD tools manufactured according to IEC 61340-5-1.

All pliers of high quality tool steel, hardened and fine-polished.

Plier handles electrostatically discharge via all components.

Surface resistance  $10^6 - 10^9$  ohms.

Pouch: Light and space-saving storage of tools.

Application: Universal set for all cutting work with electronic applications.

Order-No.	Series	
33507	Z 99 0 001 04	1
Z 41 3 04	Diagonal cutter Professional ESD. 115 mm 4 ½"	
Z 44 1 04	Diagonal cutter Professional ESD. 115 mm 4 ½"	
Z 46 4 04	Oblique end cutting nippers Professional ESD. 110 mm 4 ¼"	
Z 36 0 04	Needle nose pliers Professional ESD. 120 mm 4 ¾"	

**Wiha Info**

A number of different pliers are required for electronics.

Please ask us if you would like other pliers models for further applications.

# Wiha Professional ESD.

For high standards when it comes to precision and safety.

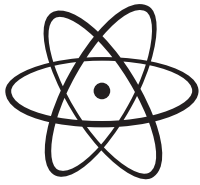

Depending on the application situation, the tweezers have extra fine, strong or extremely rugged tips

ESD coating

Optimised spring tension and precise symmetry for a firm, secure grasp

Anti-magnetic alloy made of chromium-nickel stainless steel

The new assortment of Wiha electronic tweezers expands the possibilities for exact, and at the same time, careful work with electronic components.

These precision, special or universal tweezers are rapidly becoming essential accessories for everyday electronics work due to their high-quality design: ESD safe (anti-static), anti-magnetic, stainless and acid-resistant.

Unlike purely metal tweezers, the special coating here ensures a controlled dissipation of static charges, and therefore safe, standard-compliant use.



Thanks to its wide selection of tips, the Professional ESD precision tweezers handle even tricky work effortlessly, for example on sensitive semiconductors.



Tweezers are important tools for any electronics technician to enable the necessary work to be carried out safely in the often small, confined structures of PCBs.



## Wiha Professional ESD.

- **ESD safe**  
Suitable for work at ESD workstations in accordance with IEC 61340-5-1, surface resistance  $10^6 - 10^9$  ohms
- **100% anti-magnetic**  
High-quality alloy made of chromium-nickel stainless steel with a high nickel content
- **Symmetrical**  
Exactly harmonised, precision tips for precise work
- **Acid-resistant and stainless**  
For an extra long service life
- **Non-glare surface**  
Enables optimal work

**Safety note:**

Wiha ESD electronic tweezers are non-insulating, and are therefore not suitable for work on live parts.

**Universal tweezers.****ZP 01 0 14 Universal tweezers Professional ESD.**

Standards: IEC 61340-5-1.  
 Tip form: Straight with a strong tip.  
 Design: Smooth gripping surfaces, gripping surfaces without grooves.  
 Non-glare black coated, anti-static.  
 Anti-magnetic and acid-resistant.  
 Surface resistance  $10^6 - 10^9$  ohms.  
 Material: Special alloyed, non-rusting, chromium-nickel stainless steel.  
 Application: Universal tweezers for all current electronics applications.

Order-No.	mm	Typ	g	
32318	130	AA	19	10

**ZP 46 0 14 Universal tweezers Professional ESD.**

Standards: IEC 61340-5-1.  
 Tip form: Straight with approx. 4 mm wide, round tip.  
 Design: Fine-tooth gripping surface, grooved gripping surface.  
 Non-glare black coated, anti-static.  
 Anti-magnetic and acid-resistant.  
 Surface resistance  $10^6 - 10^9$  ohms.  
 Material: Special alloyed, non-rusting, chromium-nickel stainless steel.  
 Application: Universal tweezers for all current electronics applications.

Order-No.	mm	Typ	g	
32343	145	40	29	10

**Precision tweezers.****ZP 06 0 14 Precision tweezers Professional ESD.**

Standards: IEC 61340-5-1.  
 Tip form: Straight with long, rugged tip - "American shape".  
 Design: Smooth gripping surfaces, gripping surfaces without grooves.  
 Non-glare black coated, anti-static.  
 Anti-magnetic and acid-resistant.  
 Surface resistance  $10^6 - 10^9$  ohms.  
 Material: Special alloyed, non-rusting, chromium-nickel stainless steel.  
 Application: Precision tweezers for gripping and holding electronic components.

Order-No.	mm	Typ	g	
32347	130	GG	19	10

**ZP 07 1 14 Precision tweezers Professional ESD.**

Standards: IEC 61340-5-1.  
 Tip form: Straight with approx. 1 mm wide tip.  
 Design: Smooth gripping surfaces, gripping surfaces without grooves.  
 Non-glare black coated, anti-static.  
 Anti-magnetic and acid-resistant.  
 Surface resistance  $10^6 - 10^9$  ohms.  
 Material: Special alloyed, non-rusting, chromium-nickel stainless steel.  
 Application: Precision tweezers for gripping and holding electronic components.

Order-No.	mm	Typ	g	
32325	130	PSF	18	10

**ZP 09 0 14 Precision tweezers Professional ESD.**

Standards: IEC 61340-5-1.  
 Tip form: Straight with a very slim and extra-fine tip.  
 Design: Smooth gripping surfaces, gripping surfaces without grooves.  
 Non-glare black coated, anti-static.  
 Anti-magnetic and acid-resistant.  
 Surface resistance  $10^6 - 10^9$  ohms.  
 Material: Special alloyed, non-rusting, chromium-nickel stainless steel.  
 Application: Precision tweezers for gripping and holding electronic components.

Order-No.	mm	Typ	g	
32326	135	SS	13	10

**Wiha Info**

A number of different pliers are required for electronics.

Please ask us if you would like other tweezers models for further applications.

# Wiha Professional ESD.

For high standards when it comes to precision and safety.

## Precision tweezers.



### ZP 11 0 14 Precision tweezers Professional ESD.

Standards: IEC 61340-5-1.  
 Tip form: Straight with a rugged and medium-fine tip.  
 Design: Smooth gripping surfaces, gripping surfaces without grooves.  
 Non-glare black coated, anti-static.  
 Anti-magnetic and acid-resistant.  
 Surface resistance  $10^6 - 10^9$  ohms.  
 Material: Special alloyed, non-rusting, chromium-nickel stainless steel.  
 Application: Precision tweezers for gripping and holding electronic components.

Order-No.	mm	Typ	g	
32327	120	00	21	10

## Precision tweezers.



### ZP 18 0 14 Precision tweezers Professional ESD.

Standards: IEC 61340-5-1.  
 Tip form: Straight with a needle-fine tip.  
 Design: Smooth gripping surfaces, gripping surfaces without grooves.  
 Non-glare black coated, anti-static.  
 Anti-magnetic and acid-resistant.  
 Surface resistance  $10^6 - 10^9$  ohms.  
 Material: Special alloyed, non-rusting, chromium-nickel stainless steel.  
 Application: Precision tweezers for gripping and holding electronic components.

Order-No.	mm	Typ	g	
32334	110	5	13	10



### ZP 15 0 14 Precision tweezers Professional ESD.

Standards: IEC 61340-5-1.  
 Tip form: Straight with flat, round tip, approx. 2 mm wide.  
 Design: Smooth gripping surfaces, gripping surfaces without grooves.  
 Non-glare black coated, anti-static.  
 Anti-magnetic and acid-resistant.  
 Surface resistance  $10^6 - 10^9$  ohms.  
 Material: Special alloyed, non-rusting, chromium-nickel stainless steel.  
 Application: Precision tweezers for gripping and holding electronic components.

Order-No.	mm	Typ	g	
32329	120	2a	16	10



### ZP 20 1 14 Precision tweezers Professional ESD.

Standards: IEC 61340-5-1.  
 Tip form: Round curved with a fine tip.  
 Design: Smooth gripping surfaces, gripping surfaces without grooves.  
 Non-glare black coated, anti-static.  
 Anti-magnetic and acid-resistant.  
 Surface resistance  $10^6 - 10^9$  ohms.  
 Material: Special alloyed, non-rusting, chromium-nickel stainless steel.  
 Application: Precision tweezers for gripping and holding electronic components.

Order-No.	mm	Typ	g	
32335	120	7a	15	10



### ZP 16 0 14 Precision tweezers Professional ESD.

Standards: IEC 61340-5-1.  
 Tip form: Straight with a rugged tip.  
 Design: Smooth gripping surfaces, gripping surfaces without grooves.  
 Non-glare black coated, anti-static.  
 Anti-magnetic and acid-resistant.  
 Surface resistance  $10^6 - 10^9$  ohms.  
 Material: Special alloyed, non-rusting, chromium-nickel stainless steel.  
 Application: Precision tweezers for gripping and holding electronic components.

Order-No.	mm	Typ	g	
32346	110	3c	14	10



### ZP 20 2 14 Precision tweezers Professional ESD.

Standards: IEC 61340-5-1.  
 Tip form: Round curved with short, straight, 3 mm long fine tip.  
 Design: Smooth gripping surfaces, gripping surfaces without grooves.  
 Non-glare black coated, anti-static.  
 Anti-magnetic and acid-resistant.  
 Surface resistance  $10^6 - 10^9$  ohms.  
 Material: Special alloyed, non-rusting, chromium-nickel stainless steel.  
 Application: Precision tweezers for gripping and holding electronic components.

Order-No.	mm	Typ	g	
32336	120	7abb	15	10



**Safety note:**

Wiha ESD electronic tweezers are non-insulating, and are therefore not suitable for work on live parts.

**SMD tweezers.****ZP 24 0 14 SMD tweezers Professional ESD.**

Standards: IEC 61340-5-1.  
 Tip form: Straight with a curved 45° angle flat, narrow tip.  
 Design: Smooth gripping surfaces, gripping surfaces without grooves.  
 Non-glare black coated, anti-static.  
 Anti-magnetic and acid-resistant.  
 Surface resistance 10<sup>6</sup> - 10<sup>9</sup> ohms.  
 Material: Special alloyed, non-rusting, chromium-nickel stainless steel.  
 Application: SMD special tweezers for horizontal gripping of components.

Order-No.	mm	Typ	g	
32338	120	12	15	10

**ZP 25 2 14 SMD tweezers Professional ESD.**

Standards: IEC 61340-5-1.  
 Tip form: Straight with flat, wide tip and diagonal alignment of the front gripping edge.  
 Design: Smooth gripping surfaces, gripping surfaces without grooves.  
 Non-glare black coated, anti-static.  
 Anti-magnetic and acid-resistant.  
 Surface resistance 10<sup>6</sup> - 10<sup>9</sup> ohms.  
 Material: Special alloyed, non-rusting, chromium-nickel stainless steel.  
 Application: SMD special tweezers for horizontal gripping of components.

Order-No.	mm	Typ	g	
32340	120	13	16	10

**ZP 25 3 14 SMD tweezers Professional ESD.**

Standards: IEC 61340-5-1.  
 Tip form: Curved at a 30° angle with a flat, wide tip and straight alignment of the front gripping edge.  
 Design: Smooth gripping surfaces, gripping surfaces without grooves.  
 Non-glare black coated, anti-static.  
 Anti-magnetic and acid-resistant.  
 Surface resistance 10<sup>6</sup> - 10<sup>9</sup> ohms.  
 Material: Special alloyed, non-rusting, chromium-nickel stainless steel.  
 Application: SMD special tweezers for horizontal gripping of components.

Order-No.	mm	Typ	g	
32337	120	8b	16	10

**SMD tweezers.****ZP 50 0 14 SMD tweezers Professional ESD.**

Standards: IEC 61340-5-1.  
 Tip form: Curved at a 35° angle with an approx. 2 mm wide tip, formed gripping end for 0.8 mm dia.  
 Design: Smooth gripping surface, grooved gripping surface.  
 Non-glare black coated, anti-static.  
 Anti-magnetic and acid-resistant.  
 Surface resistance 10<sup>6</sup> - 10<sup>9</sup> ohms.  
 Material: Special alloyed, non-rusting, chromium-nickel stainless steel.  
 Application: SMD special tweezers for gripping and holding horizontally-designed components.

Order-No.	mm	Typ	g	
32344	117	59	14	10

**ZP 99 0 140 02 SMD tweezer set Professional ESD, 4 pcs.****Dissipative tools, electrostatically discharging.**

Design: ESD tools manufactured according to IEC 61340-5-1.  
 All tweezers are ESD-safe (anti-static) via a special ESD coating, acid-resistant, non-rusting and 100% anti-magnetic.  
 Surface resistance 10<sup>6</sup> - 10<sup>9</sup> ohms.  
 Case: No danger to electronic components with use of ESD-safe materials.  
 Tough, space-saving metal box.  
 Application: Hand assembly of PCBs with SMD components or re-work activities.

Order-No.	Series	
32349	ZP 99 0 140 02	1
	ZP 01 0 14	Universal tweezers Professional ESD. 130 mm AA
	ZP 07 1 14	Precision tweezers Professional ESD. 130 mm PSF
	ZP 25 2 14	SMD tweezers Professional ESD. 120 mm 13
	ZP 50 0 14	SMD tweezers Professional ESD. 117 mm 59

# Wiha mixed sets.

The right tool for every application.



## Mixed sets range



### Wiha Mechanic's application sets.

Mechanic's toolbags .....	316 – 318
Quality selection set .....	318
Premium selection set .....	319
Bit sets .....	319



### Wiha VDE application sets.

Electrician's toolbags .....	320
Tool set for switch cabinet construction .....	321
Tool sets for service technicians .....	322
Tool set for electrician's belt bag .....	323 – 324
Insulated tools .....	324 – 328



### Wiha ESD application sets.

Operator Kit .....	328
Electronic Assembling Kit .....	329
Electronic Service Kit .....	329

### Wiha Info

#### Wiha application sets:

- Tool sets especially matched to your application
- Orderly, clearly laid out arrangement of the most common tools
- No additional ballast due to unnecessary tools
- Direct input of the experience of final users already integrated in product development



# Wiha mechanic's application sets.

The right tool for any application.

## Mechanic's application sets.



### Z 99 0 003 05 Tool set Professional Mix, 5 pcs.

**Design:** High quality tools in a practical toolbag.  
Pocket size approx. 31 x 24 x 4 cm.  
Weight 720 g.

**Application:** The compact basic set of pliers and screwdrivers for demanding craftsmen and industrial mechanics.

### Z 99 0 006 02 Tool set Industrial Mix, 5 pcs.

**Design:** High quality tools in a practical toolbag.  
Pocket size approx. 31 x 24 x 4 cm.  
Weight 755 g.

**Application:** The professional set of pliers and screwdrivers for demanding craftsmen and industrial mechanics.

Order-No.	Series		
26856	Z 99 0 003 05		1
	① 302	SoftFinish® slotted cabinet screwdriver. Round blade. 3,5x100 5,5x125	
	⊕ 311	SoftFinish® Phillips screwdriver. Round blade. PH2x100	
	Z 05 0 05	Professional needle-nose pliers. 200 mm 8"	
	Z 12 0 05	Diagonal cutters Professional. With Wiha DynamicJoint®. 160 mm 6 1/2"	

Order-No.	Series		
30824	Z 99 0 006 02		1
	① 302	SoftFinish® slotted cabinet screwdriver. Round blade. 3,5x100 5,5x125	
	⊕ 311	SoftFinish® Phillips screwdriver. Round blade. PH2x100	
	Z 01 0 02	Combination pliers Industrial. With Wiha DynamicJoint®. 180 mm 7"	
	Z 12 0 02	Diagonal cutters Industrial. With Wiha DynamicJoint®. 160 mm 6 1/2"	

## Wiha Info



### Wiha DynamicJoint – A new dimension in strength and durability

- **Innovative:**  
Optimised joint construction
- **Effective:**  
Low loss of force means less force needed for cutting
- **Permanent:**  
Optimal performance even after thousands of cuts

## Mechanic's application sets.

**Z 99 0 003 01** Classic Mix tool set, 5 pcs.

Design: High quality tools in a practical toolbag.  
Pocket size approx. 31 x 24 x 4 cm.  
Weight 745 g.

Application: The basic set of pliers and screwdrivers for demanding craftsmen and industrial mechanics.

Order-No.	Series	
26855	Z 99 0 003 01	1
① 302	SoftFinish® slotted cabinet screwdriver. Round blade. 5,5x125	
⊕ 311	SoftFinish® Phillips screwdriver. Round blade. PH1x80 PH2x100	
Z 01 0 01	Classic combination pliers. With Wiha DynamicJoint® and OptiGrip. 180 mm 7"	
Z 12 0 01	Classic diagonal cutters. With Wiha DynamicJoint®. 160 mm 6 ½"	

## Wiha Info

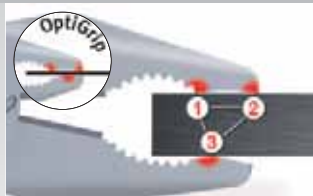
**Opti-Grip – optimal grip**  
 due to newly designed gripping surfaces

- **A firm hold:** The 'triple-point support' protects the workpiece from twisting or slipping.
- **Highly effective:** Optimum grip even with a large jaw opening – and at the same time significantly less force needed
- **A wide selection:** Now in standard Wiha combination pliers and high leverage combination pliers

## Mechanic's application sets.

**9300-019** Mechanic's toolbag, 6 pcs.

Design: High quality tools in a practical toolbag.  
Pocket size approx. 31 x 24 x 4 cm.  
Weight 875 g.

Application: Selected stock for most common applications.

Order-No.	Series	
33970	9300-019	1
① 302	SoftFinish® slotted cabinet screwdriver. 3,5x100 4,5x125	
① 302	SoftFinish® slotted workshop screwdriver. 6,5x150	
⊕ 311	SoftFinish® Phillips screwdriver. PH1x80 PH2x100	
Z 01 0 05	Combination pliers Professional. With Wiha DynamicJoint® and OptiGrip. 180 mm 7"	

**9300-020** Mechanic's toolbag, 6 pcs.

Design: High quality tools in a practical toolbag.  
Pocket size approx. 31 x 24 x 4 cm.  
Weight 815 g.

Application: Selected stock for most common applications.

Order-No.	Series	
33971	9300-020	1
① 302	SoftFinish® slotted cabinet screwdriver. 3,5x100 4,5x125	
① 302	SoftFinish® slotted workshop screwdriver. 6,5x150	
⊕ 311	SoftFinish® Phillips screwdriver. PH1x80 PH2x100	
Z 12 0 05	Diagonal cutters Professional. With Wiha DynamicJoint®. 160 mm 6 ½"	



# Wiha mechanic's application sets.

The right tool for any application.

## Mechanic's application sets.



### 9300-001 Mechanic's tool bag, 21 pcs.

Design: High-quality tools in practical tool bag with carrying handle.  
Bag format: 33 x 27 x 6 cm.  
Weight 2170 g.

Application: Selected stock for most common applications.

## Quality selection set.



### 9300-024 Quality selection set, 28 pcs.

Pouch: High-quality tools in practical tool bag with carrying handle.  
Bag format: 33 x 27 x 6 cm.  
Weight 2100 g.

Application: Selected stock for most common applications.

Order-No.	Series	
28142	9300-001	1
① 302	SoftFinish® slotted cabinet screwdriver. Round blade. 3,0x100 5,5x125	
⊕ 311	SoftFinish® Phillips screwdriver. Round blade. PH1x80 PH2x100	
○ 386	Bit holder with handle, flexible shaft, 1/4". 1/4x150	
Z 01 0 05	Combination pliers Professional. With Wiha DynamicJoint® and OptiGrip. 180 mm 7"	
Z 23 0 05	QuickFix water pump pliers Professional, box type. 250 mm 10"	
410 1000	Longlife folding metre rule, 1 m, metric, 10 segments. white	
410 2000	Longlife folding metre rule, 2 m, metric, 10 segments. white	
⊕ ⊕ ⊕ 7947-904	FlipSelector Standard, assorted, 13-pcs. 7113 S: Universal holder 58 mm, magnetic 7011 Z: 2xPH2 7012 Z: 1xPZ1 2xPZ2 1xPZ3 7015 Z: 1xT10 1xT15 1xT20 1xT25 1xT30 1xT40	
● 351 PG7	Hex fold out holder PocketStar.2	2,5 3
		4 5 6 8

Order-No.	Series	
36388	9300-024	1
① 302	SoftFinish® slotted cabinet screwdriver. Round blade. 3,0x100 5,5x125	
⊕ 311	SoftFinish® Phillips screwdriver. Round blade. PH1x80 PH2x100	
○ 388	Bit holder with handle, magnetic, 1/4". 1/4x150	
Z 12 0 01	Classic diagonal cutters. With Wiha DynamicJoint®. 160 mm 6 1/2"	
Z 21 0 01	Classic water pump pliers, box type. 250 mm 10"	
410 2000	Longlife folding metre rule, 2 m, metric, 10 segments. white	
⊕ ⊕ ⊕ 7947-904	FlipSelector Standard, assorted, 13-pcs. 7113 S: Universal holder 58 mm, magnetic 7011 Z: 2xPH2 7012 Z: 1xPZ1 2xPZ2 1xPZ3 7015 Z: 1xT10 1xT15 1xT20 1xT25 1xT30 1xT40	
● 352 H9	Hexagon L-key set in Compact holder.	352: 1,5 2 2,5 3 4 5 6 8 10

## Premium Selection Set.

**9300-026** Premium selection set, 29 pcs.

Pouch: High-quality tools in practical tool bag with carrying handle.  
Bag format: 33 x 27 x 6 cm.  
Weight 2580 g.

Application: Selected stock for most common applications.

Order-No.	Series	
36390	9300-026	1
① 3021	SoftFinish® slotted screwdriver. Round blade with lasered mm scale. 4,0x100 5,5x125	
⊕ 3111	SoftFinish® Phillips screwdriver. Round blade with lasered mm scale. PH1x80 PH2x100	
○ 388DS	Bit holder with handle, magnetic, 1/4". 1/4x150	
Z 02 0 05	Professional high-leverage combination pliers, 200 mm With Wiha DynamicJoint® and OptiGrip. 200 mm 8"	
Z 16 0 05	Professional heavy-duty diagonal cutters, 180 mm With Wiha DynamicJoint®. 180 mm 7"	
Z 22 0 01	Classic water pump pliers with push button adjustment. 250 mm 10"	
410 2000	Longlife folding metre rule, 2 m, metric, 10 segments. white	
⊕ ⊕ ⊕ 7944-907	XSelector Standard, mixed, 11 pcs. 7011 Z: 1xPH1 1xPH2 1xPH3 7012 Z: 1xPZ1 1xPZ2 1xPZ3 7015 Z: 1xT15 1xT20 1xT25 1xT30 7149: ClicFix quick release holder, magnetic, style E 6.3.	
● 369 H9S	Hexagon ball end L-key set in ErgoStar holder. 369S: 1,5 2 2,5 3 4 5 6 8 10	

## Bit sets.



With  
Xeno bits

**79187 T01** Bit set for switch cabinet construction, 14 pcs.  
Mixed sets.

Pouch: Practical, space-saving roll-up bag for the workbench and on the road.  
Application: Basic bit set for switch cabinet builders.  
With 90 mm bits for reaching lower-lying screws in switch cabinet systems, fuse boxes and terminal blocks.  
Set with Xeno bits for terminal screws.  
Can be used immediately for both machine and hand operation with handle and bit holder.

Order-No.	Series	
33142	79187 T01	1
	281-02	1xBit holder with handle, magnetic, 1/4"
	7148CM	1xCentroFix quick release holder, magnetic, style E 6.3
⊕ 7049XH	1xSL/PH1	1xSL/PH2
⊕ 7049XZ	1xSL/PZ1	1xSL/PZ2
⊕ 7041 Z	1xPH1	1xPH2
⊕ 7042 Z	1xPZ1	1xPZ2
⊕ 7045 Z	1xT10	1xT15 1xT20 1xT25



With  
Xeno bits

**79187 T02** Bit set for switch cabinet construction, 14 pcs.  
Equipped with Phillips, Xeno-PH and TORX®.

Order-No.	Series	
33143	79187 T02	1
	281-02	1xBit holder with handle, magnetic, 1/4"
	7148CM	1xCentroFix quick release holder, magnetic, style E 6.3
⊕ 7049XH	1xSL/PH1	2xSL/PH2
⊕ 7041 Z	1xPH1	2xPH2 1xPH3
⊕ 7045 Z	1xT10	1xT15 1xT20
	1xT25	1xT30



With  
Xeno bits

**79187 T03** Bit set for switch cabinet construction, 14 pcs.  
Equipped with Pozidriv, Xeno-PZ and TORX®.

Order-No.	Series	
33144	79187 T03	1
	281-02	1xBit holder with handle, magnetic, 1/4"
	7148CM	1xCentroFix quick release holder, magnetic, style E 6.3
⊕ 7049XZ	1xSL/PZ1	2xSL/PZ2
⊕ 7042 Z	1xPZ1	2xPZ2 1xPZ3
⊕ 7045 Z	1xT10	1xT15 1xT20
	1xT25	1xT30

# Wiha VDE application sets.

The right tool for any application.

## VDE application sets.



1000 V  
IEC 60900:2012

### 9300-018 Electrician's toolbag, 6 pcs.

Individually tested protective insulation 1,000 V AC, VDE and GS tested.

Design: High quality tools in a practical toolbag.  
Pocket size approx. 31 x 24 x 4 cm. Weight 825 g.

Application: For all work on or around electrical components up to 1,000 V AC.

Order-No.	Series	
33969	9300-018	1

Insulated tools:

① 320N	SoftFinish® electric slotted screwdriver. 3,0x100 4,5x125 5,5x125
⊕ 321N	SoftFinish® electric Phillips screwdriver. PH1x80 PH2x100
Z 12 0 06	Diagonal cutters Professional electric. With Wiha DynamicJoint®. 160 mm 6 ½"



## VDE application sets.



### 9300-002 Electrician's tool bag, 22 pcs.

Individually tested protective insulation 1,000 V AC, VDE and GS tested.

Design: High-quality tools in practical tool bag with carrying handle.  
Bag format approx. 33 x 27 x 5.5 cm.  
Weight 2000 g.

Application: Basic tool equipment for demanding electricians.  
For all work on or around electrical components up to 1,000 V AC.



Order-No.	Series	
28143	9300-002	1

Insulated tools:

① 320N	SoftFinish® electric slotted screwdriver. 3,5x100 5,5x125
⊕ 321N	SoftFinish® electric Phillips screwdriver. PH1x80 PH2x100
① 255-11L Z 01 0 06	Single-pole voltage tester, 110-250 volts. Combination pliers Professional electric. With Wiha DynamicJoint® and OptiGrip. 180 mm 7"
Z 12 0 06	Diagonal cutters Professional electric. With Wiha DynamicJoint®. 160 mm 6 ½"
Z 55 0 06	Stripping pliers Professional electric. 160 mm 6 ½"

Non-insulated tools:

410 1000	Longlife folding metre rule, 1 m, metric, 10 segments. white
410 2000	Longlife folding metre rule, 2 m, metric, 10 segments. white
⊕ ⊕ ⊕ ⊕ 3809 01-01	Magazine bit holder, magnetic, 1/4". 7010 Z: 1x6,5 7011 Z: 1xPH1 2xPH2 1xPH3 7012 Z: 2xPZ2 7015 Z: 1xT15 1xT20 1xT25
⊕ ⊕ ⊕ ⊕ 7947-904	FlipSelector Standard, assorted, 13-pcs. 7113 S: Universal holder 58 mm, magnetic 7011 Z: 2xPH2 7012 Z: 1xPZ1 2xPZ2 1xPZ3 7015 Z: 1xT10 1xT15 1xT20 1xT25 1xT30 1xT40



1000 V  
IEC 60900:2012

### Z 99 0 002 06 Tool set Professional electric Mix, 5 pcs.

Individually tested protective insulation 1,000 V AC, VDE and GS tested.

Design: High quality tools in a practical toolbag.  
Pocket size approx. 31 x 24 x 4 cm. Weight 780 g.

Application: For all work on or around electrical components up to 1,000 V AC.

Order-No.	Series	
26755	Z 99 0 002 06	1

Insulated tools:

① 320N	SoftFinish® electric slotted screwdriver. 3,5x100 5,5x125
⊕ 321N	SoftFinish® electric Phillips screwdriver. PH2x100
Z 05 0 06	Needle nose pliers Professional electric With Wiha DynamicJoint® and OptiGrip. 200 mm 8"
Z 12 0 06	Diagonal cutters Professional electric. With Wiha DynamicJoint®. 160 mm 6 ½"



## VDE application sets.

## VDE application sets.



With  
Xeno bits



**9300-007** Tool set for switch cabinet construction, 31 pcs.  
Individually tested protective insulation 1,000 V AC, VDE and GS tested.

Phillips blades.

Design: High-quality tools in practical tool bag with carrying handle.  
Bag format: 33 x 27 x 6 cm.  
Weight 2490 g.

Application: Basic tool set for switch cabinet builders.  
With 90 mm bits for reaching lower-lying screws in switch cabinet systems, fuse boxes and terminal blocks.  
For all work on or around electrical components up to 1,000 V AC.



With  
Xeno bits



**9300-008** Tool set for switch cabinet construction, 31 pcs.  
Individually tested protective insulation 1,000 V AC, VDE and GS tested.

Pozidriv blades.

Design: High-quality tools in practical tool bag with carrying handle.  
Bag format: 33 x 27 x 6 cm.  
Weight 2490 g.

Application: Basic tool set for switch cabinet builders.  
With 90 mm bits for reaching lower-lying screws in switch cabinet systems, fuse boxes and terminal blocks.  
For all work on or around electrical components up to 1,000 V AC.

Order-No.	Series	
33148	9300-007	1
Insulated tools:		
① 320N	SoftFinish® electric slotted screwdriver. l3,0x100 4,0x100 5,5x125	
⊕ 321N	SoftFinish® electric Phillips screwdriver. w PH1x80 PH2x100 PH3x150	
Z 05 0 06	Needle nose pliers Professional electric, With Wiha DynamicJoint® and OptiGrip. 200 mm 8"	
Z 12 0 06	Diagonal cutters Professional electric. With Wiha DynamicJoint®. 160 mm 6 1/2"	
Non-insulated tools:		
⊕ 7049XH	Professional bit, Xeno-slotted/ Phillips, style E 6.3. For terminal screws (slotted/ Phillips). SL/PH1x90SL/PH2x90	
⊕ 7041 Z	Professional bit, Phillips, style E 6.3. PH1x90 PH2x90 PH3x90	
⊕ 7045 Z	Professional bit, TORX®, style E 6.3. T10x90 T15x90 T20x90 T25x90 T30x90	
410 2000	Longlife folding metre rule, 2 m, metric, 10 segments. white	
246	Switch cabinet spirit level.	
24672SB	Automatic stripping pliers. 190 mm 7 1/2"	
● 369 H9	Hexagon ball end L-key set in Compact holder. 369: 1,5 2 2,5 3 4 5 6 8 10	

Order-No.	Series	
33149	9300-008	1
Insulated tools:		
① 320N	SoftFinish® electric slotted screwdriver. 3,0x100 4,0x100 5,5x125	
⊕ 324	SoftFinish® electric Pozidriv screwdriver. PZ1x80 PZ2x100 PZ3x150	
Z 05 0 06	Needle nose pliers Professional electric With Wiha DynamicJoint® and OptiGrip. 200 mm 8"	
Z 12 0 06	Diagonal cutters Professional electric. With Wiha DynamicJoint®. 160 mm 6 1/2"	
Non-insulated tools:		
⊕ 7049XZ	Professional bit, Xeno-slotted/ Pozidriv, style E 6.3. For terminal screws (slotted/ Pozidriv). SL/PZ1x90 SL/PZ2x90	
⊕ 7042 Z	Professional bit, Pozidriv, style E 6.3. PZ1x90 PZ2x90 PZ3x90	
⊕ 7045 Z	Professional bit, TORX®, style E 6.3. T10x90 T15x90 T20x90 T25x90 T30x90	
410 2000	Longlife folding metre rule, 2 m, metric, white	
246	Switch cabinet spirit level.	
24672SB	Automatic stripping pliers. 190 mm 7 1/2"	
● 369 H9	Hexagon ball end L-key set in Compact holder. 369: 1,5 2 2,5 3 4 5 6 8 10	

# Wiha VDE application sets.

The right tool for any application.

## VDE application sets.



**9300-025** Best-of VDE set, 12 pcs.  
Individually tested protective insulation 1,000 V AC, VDE and GS tested.

**Design:** High-quality tools in practical tool bag with carrying handle.  
Bag format: 33 x 27 x 6 cm. Weight 2120 g.

**Application:** Basic tool equipment for demanding electricians.  
For all work on or around electrical components up to 1,000 V AC.

Order-No.	Series	
36389	9300-025	1

① 3201	SoftFinish® electric slimFix slotted screwdriver. 3,5x100 4,5x125 5,5x125
⊕ 3241	SoftFinish® electric slimFix Pozidriv screwdriver. PZ1x80 PZ2x100
① 255-11L	Single-pole voltage tester, 110-250 volts. I3,0x60
● Z 05 0 06	Needle nose pliers Professional electric With Wiha DynamicJoint® and OptiGrip. 200 mm 8"
⚡ Z 16 0 06	Heavy duty diagonal cutters Professional electric. With Wiha DynamicJoint®. 180 mm 7"
⚡ Z 50 1 06	Cable cutters Professional electric. 200 mm 8"
24675SB	Automatic stripping pliers. 190 mm 7½"
246 2202	Cable stripper. 165 mm 6 ½"
410 2000	Longlife folding metre rule, 2 m, white

## VDE application sets.



**9300-030** Tool set for service technicians, 29 pcs.  
Individually tested protective insulation 1,000 V AC, VDE and GS tested. Mixed configuration.

**Design:** Combined laptop bag/ toolbag; ideal for the service technician.  
Can be completely folded open with zipper.  
Several pocket compartments for hand tools, laptop and documents.  
Sufficient space for individual additional equipment.  
Tool side bag, can be removed and used separately thanks to zip fastening. Laptop bag suitable for all common laptops.  
Bag format: approx. 47 x 35 x 22 cm. Weight 5000 g.

**Application:** Basic equipment for the service technician.  
Suitable for electrical and electronic maintenance work on machines and components.  
For all work on or around electrical components up to 1,000 V AC.

Order-No.	Series	
37137	9300-030	1

① 3201	SoftFinish® electric slimFix slotted screwdriver. 3,5x100 4,0x100
⊕ 3211	SoftFinish® electric slimFix Phillips screwdriver. PH1x80 PH2x100
⊕ 3241	SoftFinish® electric slimFix Pozidriv screwdriver. PZ1x80 PZ2x100
① 255-11L	Single-pole voltage tester, 110-250 volts. 3,0x60
Z 05 0 06	Needle nose pliers Professional electric With Wiha DynamicJoint® and OptiGrip. 200 mm 8"
Z 12 0 06	Diagonal cutters Professional electric. With Wiha DynamicJoint®. 160 mm 6 ½"
① 260P	PicoFinish slotted screwdriver. 1,5x40 2,0x40 2,5x50 3,0x50
⊕ 261P	PicoFinish Phillips screwdriver. PH00x40 PH0x50
Z 41 1 03	Diagonal cutters Electronic. 138 mm 5 ½"
Z 36 0 03	Pointed pliers Electronic. 135 mm 5 ½"
246 2202	Cable stripper. 165 mm 6 ½"
24672SB	Automatic stripping pliers. 190 mm 7½"
○ ⊕ ⊖ ⊕ ⊕ 24667	Switch cabinet key.
● 369	Hexagon ball end L-key set in Compact holder.
369:	1,5 2 2,5 3 4
	5 6 8 10





## VDE application sets.



**9300-010** Tool set for service technicians, 29 pcs.  
Individually tested protective insulation 1,000 V AC, VDE and GS tested. Phillips blades.

**Design:** Combined laptop bag/ toolbag; ideal for the service technician. Can be completely folded open with zipper. Several pocket compartments for hand tools, laptop and documents. Sufficient space for individual additional equipment. Tool side bag, can be removed and used separately thanks to zip fastening.

Laptop bag suitable for all common laptops.

Bag format: approx. 47 x 35 x 22 cm. Weight 5590 g.

**Application:** Basic equipment for the service technician. Suitable for electrical and electronic maintenance work on machines and components. For all work on or around electrical components up to 1,000 V AC.

## VDE application sets.



**9300-011** Tool set for service technicians, 29 pcs.  
Individually tested protective insulation 1,000 V AC, VDE and GS tested. Pozidriv blades.

**Design:** Combined laptop bag/ toolbag; ideal for the service technician. Can be completely folded open with zipper. Several pocket compartments for hand tools, laptop and documents. Sufficient space for individual additional equipment. Tool side bag, can be removed and used separately thanks to zip fastening.

Laptop bag suitable for all common laptops.

Bag format: approx. 47 x 35 x 22 cm. Weight 5590 g.

**Application:** Basic equipment for the service technician. Suitable for electrical and electronic maintenance work on machines and components. For all work on or around electrical components up to 1,000 V AC.

Order-No.	Series	
33151	9300-010	1
Insulated tools:		
① 320N	SoftFinish® electric slotted screwdriver. 2,5x75 3,0x100 4,0x100 5,5x125	
⊕ 321N	SoftFinish® electric Phillips screwdriver. PH1x80 PH2x100	
① 255-11L	Single-pole voltage tester, 110-250 volts.	
Z 05 0 06	Needle nose pliers Professional electric With Wiha DynamicJoint® and OptiGrip. 200 mm 8"	
Z 12 0 06	Diagonal cutters Professional electric. With Wiha DynamicJoint®. 160 mm 6 1/2"	
Non-insulated tools:		
① 260P	PicoFinish slotted screwdriver. Handle with rotating cap and rapid-turning zone. 1,5x40 2,0x40 2,5x50 3,0x50	
⊕ 261P	PicoFinish Phillips-Schraubendreher. PH00x40 PH0x50	
Z 36 0 03	Pointed pliers Electronic. 135 mm 5 1/2"	
Z 41 1 03	Diagonal cutters Electronic. 138 mm 5 1/2"	
246 2202	Cable stripper. 165 mm 6 1/2"	
24672SB	Automatic stripping pliers. 190 mm 7 1/2"	
○ ⊕ ⊖ ⊕ ⊕ 24667	Switch cabinet key.	
● 369 H9	Hexagon ball end L-key set in Compact holder. 369: 1,5 2 2,5 3 4 5 6 8 10	

Order-No.	Series	
33152	9300-011	1
Insulated tools:		
① 320N	SoftFinish® electric slotted screwdriver. 2,5x75 3,0x100 4,0x100 5,5x125	
⊕ 324	SoftFinish® electric Pozidriv screwdriver. PZ1x80 PZ2x100	
① 255-11L	Single-pole voltage tester, 110-250 volts.	
Z 05 0 06	Needle nose pliers Professional electric With Wiha DynamicJoint® and OptiGrip. 200 mm 8"	
Z 12 0 06	Diagonal cutters Professional electric. With Wiha DynamicJoint®. 160 mm 6 1/2"	
Non-insulated tools:		
① 260P	PicoFinish Schlitz-Schraubendreher. 1,5x40 2,0x40 2,5x50 3,0x50	
⊕ 261P	PicoFinish Phillips-Schraubendreher. PH00x40 PH0x50	
Z 36 0 03	Pointed pliers Electronic. 135 mm 5 1/2"	
Z 41 1 03	Diagonal cutters Electronic. 138 mm 5 1/2"	
246 2202	Cable stripper. 165 mm 6 1/2"	
24672SB	Automatic stripping pliers. 190 mm 7 1/2"	
○ ⊕ ⊖ ⊕ ⊕ 24667	Switch cabinet key.	
● 369 H9	Hexagon ball end L-key set in Compact holder. 369: 1,5 2 2,5 3 4 5 6 8 10	

# Wiha VDE application sets.

The right tool for any application.

## Slotted/ Phillips tool set.



**9300-012** Tool set for electrician's belt bag, 10 pcs.  
Individually tested protective insulation 1,000 V AC, VDE and GS tested.

**Phillips blades and stripping pliers.**

**Design:** Tool belt bag for electricians, with space for the most important tools for house and building installation.

Bag format: approx. 25 x 27 x 5 cm. Weight 1260 g.

**Application:** Basic equipment with all necessary tools for all aspects of house and building installation.

For all work on or around electrical components up to 1,000 V AC.

## Slotted/ Pozidriv tool set.



**9300-013** Tool set for electrician's belt bag, 10 pcs.  
Individually tested protective insulation 1,000 V AC, VDE and GS tested.

**Pozidriv blades and stripping pliers.**

**Design:** Tool belt bag for electricians, with space for the most important tools for house and building installation.

Bag format: approx. 25 x 27 x 5 cm. Weight 1260 g.

**Application:** Basic equipment with all necessary tools for all aspects of house and building installation.

For all work on or around electrical components up to 1,000 V AC.

Order-No.	Series	
<b>33153</b>	<b>9300-012</b>	1
Insulated tools:		
①	<b>320N</b>	SoftFinish® electric slotted screwdriver. 3,0x100 4,0x100 5,5x125
⊕	<b>321N</b>	SoftFinish® electric Phillips screwdriver. PH1x80 PH2x100
①	<b>255-11L</b>	Single-pole voltage tester, 110-250 volts. 3,0x60
	<b>Z 05 0 06</b>	Needle nose pliers Professional electric With Wiha DynamicJoint® and OptiGrip. 200 mm 8"
	<b>Z 55 0 06</b>	Stripping pliers Professional electric. 160 mm 6 ½"
Non-insulated tools:		
	<b>246 2202</b>	Cable stripper. 165 mm 6 ½"
	<b>246</b>	Tape measure 5 m.

Order-No.	Series	
<b>33154</b>	<b>9300-013</b>	1
Insulated tools:		
①	<b>320N</b>	SoftFinish® electric slotted screwdriver. 3,0x100 4,0x100 5,5x125
⊕	<b>324</b>	SoftFinish® electric Pozidriv screwdriver. PZ1x80 PZ2x100
①	<b>255-11L</b>	Single-pole voltage tester, 110-250 volts. 3,0x60
	<b>Z 05 0 06</b>	Needle nose pliers Professional electric With Wiha DynamicJoint® and OptiGrip. 200 mm 8"
	<b>Z 55 0 06</b>	Stripping pliers Professional electric. 160 mm 6 ½"
Non-insulated tools:		
	<b>246 2202</b>	Cable stripper. 165 mm 6 ½"
	<b>246</b>	Tape measure 5 m.

## Slotted/ Phillips tool set.



**9300-014** Tool set for electrician's belt bag, 10 pcs.  
Individually tested protective insulation 1,000 V AC, VDE and GS tested.

**Phillips blades and electrician's shears.**

**Design:** Tool belt bag for electricians, with space for the most important tools for house and building installation.  
Bag format: approx. 25 x 27 x 5 cm.  
Weight 1260 g.

**Application:** Basic equipment with all necessary tools for all aspects of house and building installation.  
For all work on or around electrical components up to 1,000 V AC.

Order-No.	Series	
33155	9300-014	1

Insulated tools:

① 320N	SoftFinish® electric slotted screwdriver. Individually tested protective insulation 1,000 V AC, VDE and GS tested. 3,0x100 4,0x100 5,5x125
⊕ 321N	SoftFinish® electric Phillips screwdriver. Individually tested protective insulation 1,000 V AC, VDE and GS tested. PH1x80 PH2x100
① 255-11L	Single-pole voltage tester, 110-250 volts. In accordance with DIN 57680/-6 and VDE 0680-6, GS tested, CE compliant. 3,0x60
Z 05 0 06	Needle nose pliers Professional electric With Wiha DynamicJoint® and OptiGrip. 200 mm 8"

Non-insulated tools:

Z 71 5 06	Electrician's / craftsman's cutters Professional electric. 145 mm 5 ¾"
246 2202	Cable stripper. 165 mm 6 ½"
246	Tape measure 5 m.

## Insulated tools.



**352N S7** Insulated L-key set, 7 pcs.  
Protective insulation 1,000 V AC.

**Standards:** Manufactured according to EN/IEC 60900:2012.  
**Design:** Practical, space-saving roll-up bag for the workbench and on the road.  
**Material:** Chrome vanadium steel, oil-hardened.  
**Application:** Safe installation of terminals and sleeves, especially for cable-branch clamping rings.  
For all work on or around electrical components up to 1,000 V AC.

Order-No.	Series	
33182	352N S7	1
● 352N	3 4 5 6 8 10 12	



**352N** Insulated L-key.  
Protective insulation 1,000 V AC.

**Standards:** Manufactured according to EN/IEC 60900:2012.  
**Material:** Chrome vanadium steel, oil-hardened.  
**Application:** Safe installation of terminals and sleeves, especially for cable-branch clamping rings.  
For all work on or around electrical components up to 1,000 V AC.

Order-No.	●	g	
36659	3	20	1
36660	4	25	1
36661	5	45	1
36662	6	60	1
36663	8	110	1
36664	10	230	1
36665	12	350	1

# Wiha VDE application sets.

The right tool for any application.

## Insulated tools.



**5590N T8** Insulated single-sided open-end spanner set, 8 pcs.  
Protective insulation 1,000 V AC.

Standards: DIN 7446.  
Manufactured according to EN/IEC 60900:2012.  
Design: Position of jaws angled downward 15°. Practical, space-saving roll-up bag for the workbench and on the road.  
Material: Forged chrome vanadium steel.  
Application: Safe installation of terminals and sleeves. For all work on or around electrical components up to 1,000 V AC.

Order-No.	Series									
33180	5590N T8									1
	○ 5590N	7	8	10	11	13	15	17	19	

## Insulated tools.



**5590N T8** Insulated single-sided open-end spanner set, 8 pcs.  
Protective insulation 1,000 V AC.



Standards: DIN 7446.  
Manufactured according to EN/IEC 60900:2012.  
Design: Position of jaws angled downward 15°. Practical, space-saving roll-up bag for the workbench and on the road.  
Material: Forged chrome vanadium steel.  
Application: Safe installation of terminals and sleeves. For all work on or around electrical components up to 1,000 V AC.

Order-No.	Series									
33180	5590N T8									1
	○ 5590N	7	8	10	11	13	15	17	19	



**5590N** Insulated single-sided open-end spanner.  
Protective insulation 1,000 V AC.

Standards: DIN 7446.  
Manufactured according to EN/IEC 60900:2012.  
Design: Position of jaws angled downward 15°. Practical, space-saving roll-up bag for the workbench and on the road.  
Material: Forged chrome vanadium steel.  
Application: Safe installation of terminals and sleeves. For all work on or around electrical components up to 1,000 V AC.

Order-No.	○		
36543	6	32	1
36544	7	32	1
36586	8	34	1
36639	9	38	1
36640	10	40	1
36641	11	46	1
36642	12	54	1
36643	13	65	1
36644	14	80	1
36645	15	92	1
36646	16	115	1
36647	17	115	1
36648	19	150	1
36649	22	190	1
36650	24	300	1

## Insulated tools.

**7207N K1001** 3/8" reversible ratchet set, 10 pcs.

Protective insulation 1,000 V AC.

- Standards: Manufactured according to EN/IEC 60900:2012.
- Design: Simple locking of the actuating tools with positive locking on the drive square. Clockwise and anticlockwise running.
- Material: Chrome vanadium steel.
- Case: Practical, rugged plastic box.
- Content: Orderly, clearly laid-out arrangement of the tools for fast, clean work.
- Insulated tools:  
 Insulated 3/8" reversible ratchet, 190 mm (246N 02 series)  
 Insulated 3/8" extension, 125 mm (7210N series)  
 Insulated 3/8" nut driver inserts, metric  
 Ratchet with simple locking of the actuating tools with positive locking on the drive square; clockwise and anticlockwise running.
- Application: Safe installation of terminals and sleeves.  
 For all work on or around electrical components up to 1,000 V AC.
- Note: Use of the nut driver inserts and extensions is only permitted with an insulated reversible ratchet.

Order-No.	Series	
33183	7207N K1001	1
○	7207N	8 10 11 12 13 14 17 19

**7207N** Insulated nut driver set.

Protective insulation 1,000 V AC.

- Standards: Manufactured according to EN/IEC 60900:2012.
- Design: Simple locking of the actuating tools with positive locking on the drive square.
- Material: Chrome vanadium steel.
- Application: Safe installation of terminals and sleeves.  
 For all work on or around electrical components up to 1,000 V AC.
- Note: Use of the nut driver inserts and extensions is only permitted with an insulated reversible ratchet.

Order-No.	○		
36673		Reversible ratchet 3/8" x 190 mm	1
36674		Extension 3/8" x 125 mm	1
36675	8	Nut driver insert	1
36676	10	Nut driver insert	1
36677	11	Nut driver insert	1
36678	12	Nut driver insert	1
36679	13	Nut driver insert	1
36680	14	Nut driver insert	1
36681	17	Nut driver insert	1
36682	19	Nut driver insert	1

## Insulated tools.

**7208N K1001** 1/2" reversible ratchet set, 10 pcs.

Protective insulation 1,000 V AC.

- Standards: Manufactured according to EN/IEC 60900:2012.
- Design: Simple locking of the actuating tools with positive locking on the drive square. Clockwise and anticlockwise running.
- Material: Chrome vanadium steel.
- Case: Practical, rugged plastic box.
- Content: Orderly, clearly laid-out arrangement of the tools for fast, clean work.
- Insulated tools:  
 Insulated 1/2" reversible ratchet, 260 mm (246N 03 series)  
 Insulated 1/2" extension, 125 mm (7210N series)  
 Insulated 1/2" nut driver inserts, metric
- Application: Safe installation of terminals and sleeves.  
 For all work on or around electrical components up to 1,000 V AC.
- Note: Use of the nut driver inserts and extensions is only permitted with an insulated reversible ratchet.

Order-No.	Series	
33184	7208N K1001	1
○	7208N	10 12 13 14 17 19 22 24

**7208N** Insulated nut driver set.

Protective insulation 1,000 V AC.

- Standards: Manufactured according to EN/IEC 60900:2012.
- Design: Simple locking of the actuating tools with positive locking on the drive square.
- Material: Chrome vanadium steel.
- Application: Safe installation of terminals and sleeves.  
 For all work on or around electrical components up to 1,000 V AC.
- Note: Use of the nut driver inserts and extensions is only permitted with an insulated reversible ratchet.

Order-No.	○		
36683		Reversible ratchet 1/2" x 260 mm	1
36684		Extension 1/2" x 125 mm	1
36685	10	Nut driver insert	1
36686	12	Nut driver insert	1
36687	13	Nut driver insert	1
36688	14	Nut driver insert	1
36689	17	Nut driver insert	1
36690	19	Nut driver insert	1
36691	22	Nut driver insert	1
36692	24	Nut driver insert	1



# Wiha VDE + ESD application sets.

The right tool for any application.

## Insulated tools.



### 5589N K7 Insulated ratchet box spanner set, 7 pcs. Protective insulation 1,000 V AC.

Standards: Manufactured according to EN/IEC 60900:2012.  
Material: Chrome vanadium steel.  
Case: Practical, rugged plastic box.  
Orderly, clearly laid-out arrangement of the tools for fast, clean work.  
Application: Safe installation of terminals and sleeves.  
For all work on or around electrical components up to 1,000 V AC.

Order-No.	Series								
33181	5589N K7								1
	5589N	8	10	12	13	14	17	19	



### 5589N Insulated ratchet box spanners. Protective insulation 1,000 V AC.

Standards: Manufactured according to EN/IEC 60900:2012.  
Material: Chrome vanadium steel.  
Application: Safe installation of terminals and sleeves.  
For all work on or around electrical components up to 1,000 V AC.

Order-No.			
36666	8	50	1
36667	10	56	1
36668	12	68	1
36669	13	80	1
36670	14	86	1
36671	17	174	1
36672	19	208	1

## ESD application sets.



ESD-Safe

### 9300-015 Wiha operator kit, 5 pcs.

**Dissipative tools, electrostatically discharging.**  
Design: ESD tools manufactured according to IEC 61340-5-1.  
Maximum protection of electronic components from electrostatically discharging tools and packaging.  
Handy leather bag (ESD capability), ideal for all overall pockets.  
No danger of injury to users or damage to workwear from sharp or loose tools in overall pockets.  
Application: The most important tools for automatic insertion machines in continuous operation.

Order-No.	Series			
33504	9300-015			1
	272	Precision ESD slotted screwdriver. Dissipative handle, ESD-safe. 2,5x50		
	273	Precision ESD Phillips screwdriver. Dissipative handle, ESD-safe. PH0x50		
	ZP 01 0 14	Universal tweezers Professional ESD. 130 mm AA		
	Z 71 1 06	SMD belt shears		
	246	Dust and dirt brush .		

## ESD application sets.



ESD-Safe

**9300-016** Wiha electronic assembling kit, 9 pcs.**Dissipative tools, electrostatically discharging.**

Design: ESD tools manufactured according to IEC 61340-5-1.  
Robust and space-saving storage of tools in ESD-capable bag.

Application: The most important tools for hand assembly of electronic components and re-work activities.

Order-No.	Series		
33505	9300-016		1
① 272	Precision ESD slotted screwdriver. Dissipative handle, ESD-safe. 2,0x40 2,5x50		
⊕ 273	Precision ESD Phillips screwdriver. Dissipative handle, ESD-safe. PH00x40 PH0x50		
⊛ 278	Precision ESD TORX® screwdriver. Dissipative handle, ESD-safe. T5x40 T6x40		
Z 36 0 04	Needle nose pliers Professional ESD. 120 mm 4 ¾"		
Z 41 3 04	Diagonal cutter Professional ESD. 115 mm 4 ½"		
ZP 01 0 14	Universal tweezers Professional ESD. 130 mm AA		

## ESD application sets.



ESD-Safe

**9300-017** Wiha electronic service kit, 8 pcs.**Dissipative tools, electrostatically discharging.**

Design: ESD tools manufactured according to IEC 61340-5-1.  
Robust and space-saving storage of tools in ESD-capable bag.

Application: Set combination ideally suited to maintenance work with electronic components.

Order-No.	Series		
33506	9300-017		1
○ 2691ESD	SYSTEM 4 SoftFinish®-telescopic ESD handle. Dissipative handle, ESD-safe. 4,0x105		
① 269	SYSTEM 4 slotted Phillips reversible blade. 2,0xPH00 3,0xPH0		
⊛ 269	SYSTEM 4 TORX® reversible blade. T5xT6		
● 269	SYSTEM 4 combined ball end hex - hex reversible blade. 1,5x1,5		
Z 36 0 04	Needle nose pliers Professional ESD. 120 mm 4 ¾"		
Z 44 1 04	Diagonal cutter Professional ESD. 115 mm 4 ½"		
ZP 01 0 14	Universal tweezers Professional ESD. 130 mm AA		

**Safety note:**

Wiha ESD tools are non-insulating,  
and are therefore not suitable  
for work on live parts.

# Wiha soft-face hammers.

Wiha makes it possible: Optimal transmission of force to sensitive components.



## Soft-face hammers range.



**Wiha Safety soft-face hammer.**  
Safety in every detail.

332 – 336



**Wiha dead-blow hammer.**  
A star in the world of recoilless tools.

337 – 339



All Wiha soft-face hammers  
carry the GS Mark.

## Wiha Info

### Explanation of the colour-code system

Wiha makes it easy to differentiate between different levels of hammer face hardness with its colour coding system.

Application	Material	Hammer face
<b>For sensitive materials:</b> Window construction, light metal construction, furniture and interior fittings industry, light assembly, tradeshow construction	Elastomer	soft ● ■
<b>For sturdy applications:</b> Tile laying, paving, curbstone setting, prefabricated house construction, light gardening and landscaping setting tasks	Rubber	medium-soft ●
<b>For universal applications:</b> Tool and machine construction, metal working, automobile repairs, panel beating, sheet metal and assembly work.	Polyurethane	medium-hard ● ■
<b>For heavy-duty:</b> Assembly and disassembly, sheet metal work, building and construction work, workshop tasks	Cellulose acetate	hard ●
<b>For striking power:</b> Building and construction industry, foundry, mould making, road work, forestry and agriculture, gardening and landscaping	Polyamide	very hard ○

○ = Round face  
□ = Square face



# Wiha Safety soft-face hammer.

Perfect safety in every detail.



*Safety Concept:*  
All parts are interlocked and clamped together by means of a nut and bolt assembly.

The specialty of the Safety Programme lies in the multitude of different colour coded hammer faces. These can, for different applications, be selected to suit your size and hardness requirements. This tool allows you to use single strikes on softer materials such as soft woods, plastics or aluminium as well as allowing for powerful repeated strikes required in foundries and tough industry applications.

Depending on the size and weight of the tool there are different hammer face options available.

All Safety Tools are equipped with hardwood Hickory handles. Due to its high strength properties, Hickory has proven itself over the years as the ideal handle material.



*The Wiha Safety soft-face hammer with black/white faces is the professional helper for garden and landscaping work.*

The ergonomic outline of the handle in combination with the oval shape and special finish ensure that even with sweaty or slippery hands, the handle will not rotate or slip.



*The powder-coated safety shells made from malleable cast iron clamp the head and handle securely together. The 840 mm long sledge hammer is the ideal length for special applications, e.g. for rail-track construction.*



## Wiha Safety soft-face hammer.

- Safety hammer with interchangeable faces of different hardnesses makes it the most suited hammer for all applications
- Nuts in the face and grooves in the shell provide a secure connection of the hammer housing
- High strength hickory handle guarantees longer tool life
- Each hammer piece is also available as a spare part



Wear safety glasses and protective gloves when working with soft face hammers. In addition, observe the national standards and regulations.





Wear safety glasses and protective gloves when working with soft face hammers. In addition, observe the national standards and regulations.

### Hammers with identical faces.



**832-33** Safety soft-face hammer, black/ black.

Faces: Black: Medium soft, wear-resistant caoutchouc (rubber).  
 Housing: Powder coated safety shells made from malleable cast iron with grooves to clamp faces and handle in place.  
 Shaft: Hickory handle with ergonomic profile and non-slip surface.  
 Standards: GS-mark: Tested safety.  
 Application: Tile laying, paving, curbstone setting, dry wall construction, light gardening and landscaping setting tasks.

Order-No.	●!	↵ g ↵	⊞	⊞	⊞
26509	30	300	87	290	5
26431	40	640	110	325	5
26432	50	1100	131	360	2
26433	60	1700	150	400	2
26439	80	3200	185	490	2



**832-55** Safety soft-face hammer, yellow/ yellow.

Faces: Yellow: Medium hard, colourfast and wear-resistant polyurethane.  
 Application: Tool and machine construction, metal working, automobile repairs, panel beating, sheet metal and assembly work.

Order-No.	●!	↵ g ↵	⊞	⊞	⊞
26640	30	300	87	290	5
26641	40	640	110	325	5
26642	50	1100	131	360	2
26643	60	1700	150	400	2



**832-99** Safety soft-face hammer, white/ white.

Faces: White: Very hard, colourfast and wear-resistant (nylon®).  
 Application: Building and construction industries, foundry, mould making, road work, forestry and agriculture, gardening and landscaping.

Order-No.	●!	↵ g ↵	⊞	⊞	⊞
26644	30	300	87	290	5
26645	40	640	110	325	5
26646	50	1100	131	360	2
26647	60	1700	150	400	2
26648	80	3000	185	490	2
26674	80L	3450	185	840	Sledge hammer

### Hammers with combined faces.



**832-15** Safety soft-face hammer, blue/ yellow.

Faces: Blue: Soft, colourfast and wear-resistant elastomer.  
 Yellow: Medium hard, colourfast and wear-resistant polyurethane.  
 Housing: Powder coated safety shells made from malleable cast iron with grooves to clamp faces and handle in place.  
 Shaft: Hickory handle with ergonomic profile and non-slip surface.  
 Standards: GS-mark: Tested safety.  
 Application: Window construction, light metal construction, furniture and interior fittings industries, light assembly, tradeshow construction. Tool and machine construction, metal working, automobile repairs, panel beating, sheet metal and assembly work.

Order-No.	●!	↵ g ↵	⊞	⊞	⊞
26653	30	300	87	290	5
26654	40	640	110	325	5
26655	50	1100	131	360	2
26656	60	1700	150	400	2



**834-15** Safety soft-face hammer, blue/ yellow, square face.

Faces: Blue: Soft, colourfast and wear-resistant elastomer.  
 Yellow: Medium hard, colourfast and wear-resistant polyurethane.  
 Housing: Powder coated safety shells made from malleable cast iron with grooves to clamp faces and handle in place.  
 Shaft: Hickory handle with ergonomic profile and non-slip surface.  
 Standards: GS-mark: Tested safety.  
 Application: Window construction, light metal construction, furniture and interior fittings industries, light assembly, tradeshow construction. Tool and machine construction, metal working, automobile repairs, panel beating, sheet metal and assembly work.  
 Extra: Square face can be turned by 90° for optimum working on edges and borders.

Order-No.	■!	↵ g ↵	⊞	⊞	⊞
26662	40	650	110	325	5

### Wiha Info

#### Explanation of the colour-code system

Hammer face		Material	
Round face	Square face		
		Elastomer	soft
		Rubber	medium-soft
		Polyurethane	medium-hard
		Cellulose acetate	hard
		Polyamide	very hard

# Wiha Safety soft-face hammer.

Perfect safety in every detail.

## Hammers with combined faces.



### 832-13 Safety soft-face hammer, blue/ black.

Faces: Blue: Soft, colourfast and wear-resistant elastomer.  
Black: Medium soft, wear-resistant caoutchouc (rubber).

Housing: Powder coated safety shells made from malleable cast iron with grooves to clamp faces and handle in place.

Shaft: Hickory handle with ergonomic profile and non-slip surface.

Standards: GS-mark: Tested safety.

Application: Window construction, light metal construction, furniture and interior fittings industries, light assembly, tradeshow construction.  
Tile laying, paving, curbstone setting, dry wall construction, light gardening and landscaping setting tasks.

Order-No.	●!	g	g	g	g
26649	30	300	87	290	5
26650	40	640	110	325	5
26651	50	1100	131	360	2
26652	60	1700	150	400	2

## Hammers with combined faces.



### 832-38 Safety soft-face hammer, black/ transparent orange.

Faces: Black: Medium soft, wear-resistant caoutchouc (rubber).  
Transparent orange: Hard, colourfast and wear-resistant cellulose acetate.

Housing: Powder coated safety shells made from malleable cast iron with grooves to clamp faces and handle in place.

Shaft: Hickory handle with ergonomic profile and non-slip surface.

Standards: GS-mark: Tested safety.

Application: Tile laying, paving, curbstone setting, dry wall construction, light gardening and landscaping setting tasks. Assembly and disassembly, sheet metal work, building and construction work, workshop tasks.

Order-No.	●!	g	g	g	g
26611	30	300	87	290	5
26612	40	640	110	325	5
26613	50	1100	131	360	2
26614	60	1700	150	400	2



### 832-35 Safety soft-face hammer, black/ yellow.

Faces: Black: Medium soft, wear-resistant caoutchouc (rubber).  
Yellow: Medium hard, colourfast and wear-resistant polyurethane.

Housing: Powder coated safety shells made from malleable cast iron with grooves to clamp faces and handle in place.

Shaft: Hickory handle with ergonomic profile and non-slip surface.

Standards: GS-mark: Tested safety.

Application: Tile laying, paving, curbstone setting, dry wall construction, light gardening and landscaping setting tasks.  
Tool and machine construction, metal working, automobile repairs, panel beating, sheet metal and assembly work.

Order-No.	●!	g	g	g	g
26434	30	300	87	290	5
26435	40	640	110	325	5
26436	50	1100	131	360	2
26437	60	1700	150	400	2



### 832-39 Safety soft-face hammer, black/ white.

Faces: Black: Medium soft, wear-resistant caoutchouc (rubber).  
White: Very hard, colourfast and wear-resistant polyamide (nylon®).

Housing: Powder coated safety shells made from malleable cast iron with grooves to clamp faces and handle in place.

Shaft: Hickory handle with ergonomic profile and non-slip surface.

Standards: GS-mark: Tested safety.

Application: Tile laying, paving, curbstone setting, dry wall construction, light gardening and landscaping setting tasks.  
Building and construction industries, foundry, mould making, road work, forestry and agriculture, gardening and landscaping.

Order-No.	●!	g	g	g	g
26657	30	300	87	290	5
26658	40	640	110	325	5
26659	50	1100	131	360	2
26660	60	1700	150	400	2
26582	80	3000	185	490	2
26661	80L	3450	185	840	Sledge hammer



Wear safety glasses and protective gloves when working with soft face hammers. In addition, observe the national standards and regulations.

### Substitute faces.



#### 831-1 Hammer face, blue, for Safety soft-face hammer.

Material: Soft elastomer, colourfast and wear-resistant.

Application: Window construction, light metal construction, furniture and interior fittings industries, light assembly, tradeshow construction.

Order-No.	●i	↕ g	≡
26663	30	17	5
26664	40	39	5
26665	50	85	2
26666	60	135	2



#### 833-1 Square hammer face, blue, for Safety soft-face hammer.

Material: Soft elastomer, colourfast and wear-resistant.

Application: Window construction, light metal construction, furniture and interior fittings industries, light assembly, tradeshow construction.

Extra: Square face can be turned by 90° for optimum working on edges and borders.

Order-No.	■i	↕ g	≡
26673	40	47	5



#### 831-3 Hammer face, black for Safety soft-face hammer.

Material: Medium soft caoutchouc (rubber), wear-resistant.

Application: Tile laying, paving, curbstone setting, dry wall construction, light gardening and landscaping setting tasks.

Order-No.	●i	↕ g	≡
26422	30	27	5
26423	40	62	5
26424	50	111	2
26425	60	192	2
26426	80	410	also for sledge hammers

### Substitute faces.



#### 831-5 Hammer face, yellow, for Safety soft-face hammer.

Material: Medium hard polyurethane, colourfast and wear-resistant.

Application: Tool and machine construction, metal working, automobile repairs, panel beating, sheet metal and assembly work.

Order-No.	●i	↕ g	≡
26427	30	27	5
26428	40	57	5
26429	50	116	2
26430	60	190	2



#### 833-5 Square hammer face, yellow for Safety soft-face hammer.

Material: Medium hard polyurethane, colourfast and wear-resistant.

Application: Tool and machine construction, metal working, automobile repairs, panel beating, sheet metal and assembly work.

Extra: Square face can be turned by 90° for optimum working on edges and borders.

Order-No.	■i	↕ g	≡
26438	40	65	5



#### 831-8 Hammer face, transparent orange, for Safety soft-face hammer.

Material: Hard cellulose acetate, colourfast and wear-resistant.

Application: Assembly and disassembly, sheet metal work, building and construction work, workshop tasks.

Order-No.	●i	↕ g	≡
26615	30	27	5
26616	40	57	5
26618	50	118	2
26620	60	195	2



#### 831-9 Hammer face, white, for Safety soft-face hammer.

Material: Very hard polyamide (Nylon®), colourfast and wear-resistant.

Application: Building and construction industries, foundry, mould making, road work, forestry and agriculture, gardening and landscaping.

Order-No.	●i	↕ g	≡
26510	30	24	5
26511	40	56	5
26512	50	110	2
26513	60	187	2
26514	80	400	also for sledge hammers

### Wiha Info

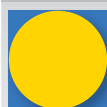

Wiha square hammer heads offer a 27% greater striking surface than round hammer heads with the same diameter. They are thus particularly suitable for working on corners and edges.

# Wiha Safety soft-face hammer.

Perfect safety in every detail.

## Substitute housing and substitute handles.



### 829-0 Housing set for Safety soft-face hammer.

Material: Powder-coated malleable cast-iron shells, 2 pieces, with screw and counternut.

Properties: Elastic malleable cast iron, crack resistant.

Order-No.	●	g		
26668	30	170		1
26669	40	390		1
26670	50	670		1
26671	60	1040		1
26672	80	1900	also for sledge hammers	1



### 830-0 Hickory handle for Safety soft-face hammer.

Material: Carefully selected hickory with non-slip surface.

Properties: Over the years, hickory, an extremely hard wood, has proven to be the best material for hammer handles.

Order-No.	●	g	g	
26417	30	260	90	5
26418	40	280	130	5
26419	50	310	190	2
26420	60	340	250	2
26421	80	400	310	2
26667	80L	800	650	for Sledge hammer

## Hammer set.



### 832 B8 Safety hammer set, 8 pcs.

Shaft: Hickory handle with ergonomic profile and non-slip surface.

Standards: GS-mark: Tested safety.

Design: Hammer size 40 with 6 exchangeable hammer heads in metal case, incl. hex keys for simple exchange.

Content: 832-38 Safety soft-head hammer orange/black (hard/medium-soft)  
 831-1 soft hammer face, blue  
 831-3 medium soft hammer face, black  
 831-5 medium hard hammer face, yellow  
 831-9 very hard hammer face, white  
 833-1 soft square hammer face, blue  
 833-5 medium hard square hammer face, yellow  
 352 size 6 hex L-key, long made of chrome-vanadium steel, through hardened, nickel-plated.

Application: Practical set with different faces for every application.

Order-No.	Series	
28050	832 B8	1

## Wiha Info

### Explanation of the colour-code system

Hammer face		Material	
Round face	Square face		
		Elastomer	soft
		Rubber	medium-soft
		Polyurethane	medium-hard
		Cellulose acetate	hard
		Polyamide	very hard

## Wiha Info

When replacing heads or handles, please note the following torques:

size 30 = 20 Nm  
 size 40 = 40 Nm  
 size 50 = 70 Nm  
 size 60 = 70 Nm  
 size 80 = 80 Nm

# Wiha dead-blow hammer.

A star in the world of recoilless tools.



Wiha has now put an end to the familiar problems associated with the stress on joints and muscles when working with recoiling hammers. The Wiha dead-blow hammer has a special filling in the hammer casing to prevent recoil.

Professionals who use these hammers on a continuous basis, for example, in tool and die shops or in body maintenance and sheet-metal work, appreciate the benefits of this recoilless hammer from Wiha.



*The face is made of medium-hard polyurethane for full blows and protects delicate surfaces and edges.*

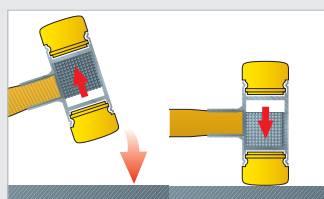

*The special metal filling in the hammer casing enables recoilless working.*



*Simple replacement of outworn hammer faces:*  
 1. Secure the hammer in the vice, lift away the old hammer face.  
 2. Press in the new hammer face in the vice.



## Wiha dead-blow hammer.

- Recoilless working due to special metal filling in the hammer casing
- The hammer weight is increased by about 25% for additional power
- Easy on delicate surfaces and edges as a result of its comfort cushioning surface
- Available with hickory wood handle or steel tube shaft
- Faces and wooden handles available as spare parts



Wear safety glasses and protective gloves when working with soft face hammers. In addition, observe the national standards and regulations.



# Wiha dead-blow hammer.

A star in the world of recoilless tools.

## Hammers with wooden handle.



**NEW**

### 8001 Dead-blow hammer with hickory handle.

Faces: Both are white: very hard polyamide (Nylon®), colourfast and wear-resistant.  
 Housing: Manufactured from precision steel tubing with welded on shaft, powder coated.  
 Shaft: Hickory handle coated with ergonomic profile and high quality surface.  
 Standards: GS-mark: Tested safety.  
 Application: Controlled strikes e.g. on workpieces being held by vices or assembly work.  
 Extra: With cast iron balls inside the hammer head for recoilless work.

Order-No.	●!	g	mm	mm	mm
39008	30	460	115	350	5
39010	40	760	125	375	5
39012	50	1250	135	385	2
39014	60	2000	165	420	2

## Sledge hammers.



### 800 Dead-blow sledge hammer with hickory handle.

Faces: Both yellow: Medium hard, colourfast and wear-resistant polyurethane.  
 Housing: Manufactured from precision steel tubing with welded on shaft, powder coated.  
 Shaft: Hickory handle coated with ergonomic profile and high quality surface.  
 Standards: GS-mark: Tested safety.  
 Application: Controlled positioning strikes in assembly and disassembly, straightening.  
 Extra: With cast iron balls inside the hammer head for recoilless work.

Order-No.	●!	g	mm	mm	mm
02101	80	4550	205	880	1
02091	100	6860	210	1000	1



### 800 Dead-blow hammer with hickory handle.

Faces: Both yellow: Medium hard, colourfast and wear-resistant polyurethane.  
 Housing: Manufactured from precision steel tubing with welded on shaft, powder coated.  
 Shaft: Hickory handle coated with ergonomic profile and high quality surface.  
 Standards: GS-mark: Tested safety.  
 Application: Controlled strikes e.g. on workpieces being held by vices or assembly work.  
 Extra: With cast iron balls inside the hammer head for recoilless work.

Order-No.	●!	g	mm	mm	mm
02092	25	320	108	320	5
02093	30	460	115	350	5
02094	35	580	118	355	5
02095	40	760	125	375	5
02096	45	1000	130	380	2
02097	50	1250	135	385	2
02098	60	2000	165	420	2
02099	70	2600	165	430	2



Wear safety glasses and protective gloves when working with soft face hammers. In addition, observe the national standards and regulations.

## Hammers with steel tube shaft.



### NEW

#### 8021 Dead-blow hammer with steel tube shaft.

Faces: Both are white: very hard polyamide (Nylon®), colourfast and wear-resistant.  
 Housing: Manufactured from precision steel tubing, powder coated.  
 Shaft: Welded, powder coated steel tube with ergonomic rubber handle.  
 Standards: GS-mark: Tested safety.  
 Application: Controlled strikes e.g. on workpieces being held by vices or assembly work.  
 Extra: With cast iron balls inside the hammer head for recoilless work.

Order-No.	●!	↕ g	↔ g	↔ g	↔ g
39017	30	600	115	290	5
39019	40	850	125	305	5
39021	50	1400	135	365	2
39022	60	2050	165	375	2



#### 802 Dead-blow hammer with steel tube shaft.

Faces: Both yellow: Medium hard, colourfast and wear-resistant polyurethane.  
 Housing: Manufactured from precision steel tubing, powder coated.  
 Shaft: Welded, powder coated steel tube with ergonomic rubber handle.  
 Standards: GS-mark: Tested safety.  
 Application: Controlled strikes e.g. on workpieces being held by vices or assembly work.  
 Extra: With cast iron balls inside the hammer head for recoilless work.

Order-No.	●!	↕ g	↔ g	↔ g	↔ g
02122	25	520	108	288	5
02123	30	600	115	290	5
02124	35	700	118	300	5
02125	40	850	125	305	5
02126	45	1060	130	310	2
02127	50	1400	135	365	2
02128	60	2050	165	375	2
02129	70	2750	165	385	2

## Spare parts.



#### 800S Hickory handle for dead-blow hammer.

Material: Carefully selected hickory with high quality surface.  
 Properties: Over the years, hickory, an extremely hard wood, has proven to be the best material for hammer handles.

Order-No.	●!	↕ g	↔ g	↔ g
02113	25	295	69	10
02114	30/35	320	113	10
02115	40/45	335	123	10
02116	50	335	133	10
02117	60/70	360	165	5
28051	80	800	550	VPA GS-mark 1
28052	100	900	860	VPA GS-mark 1



### NEW

#### 8001K Impact head, white for dead-blow hammer.

Material: Very hard polyamide (Nylon®), absolutely colourfast and wear-resistant.

Order-No.	●!	↕ g	↔ g
39149	30	22	5
39150	40	45	5
39151	50	86	2
39152	60	130	2



#### 800K Hammer face, yellow for dead-blow hammer.

Material: Medium hard polyurethane, colourfast and wear-resistant.

Order-No.	●!	↕ g	↔ g
02103	25	16	10
02104	30	22	10
02105	35	30	10
02106	40	45	10
02107	45	63	5
02108	50	86	5
02109	60	130	5
02110	70	178	5
02111	80	250	2
02102	100	449	2

# Wiha measurement tools/articulated hose systems.

Wiha makes it possible: Measure and cooling with Swiss precision.



## Measurement tools range



<b>Wiha fibre-glass-reinforced callipers.</b> Precision made in Switzerland. ....	342
<b>digiMax<sup>®</sup>, caliMax<sup>®</sup>, dialMax<sup>®</sup>, dialMax<sup>®</sup> ESD.</b> .....	343



<b>Wiha Longlife<sup>®</sup> Plus Composite.</b> .....	344
--	-----



<b>Wiha fibre-glass-reinforced folding rulers.</b> Perfection up to 2 m in length. ....	345
<b>Longlife<sup>®</sup> All in One, Longlife<sup>®</sup> Plus and Longlife<sup>®</sup>.</b> .....	346

## Articulated hose range



<b>Wiha articulated hose system.</b> The universal pipe system .....	347
<b>maxiflex system <math>\varnothing</math> 1/4"</b> .....	348
<b>maxiflex system <math>\varnothing</math> 1/2"</b> .....	349



# Wiha fibre-glass-reinforced callipers.

Precision made in Switzerland.

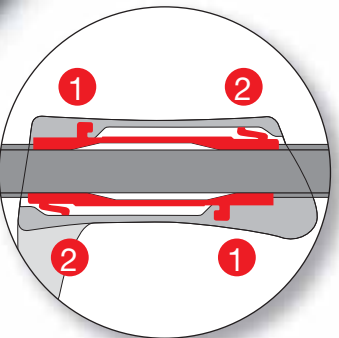

Play free motion of the sliding components through precision design for precise measurement results:

1. Fixed position
2. Flexible spring component



## Wiha fibre-glass-reinforced callipers.

The Wiha callipers from the "max" range are manufactured since 1965 with Swiss precision. Due to the unique advantages made available by the non-metal, high-tech material with 50% fibre-glass component, the callipers have found new applications where their advantages are distinct when compared to the more heavy metal designs.

They are particularly suitable for measuring high-quality and highly sensitive objects.

These measuring tools are also ideal for all metal, wood and plastic-processing applications, for field staff and service engineers.

Thanks to their antimagnetic properties, Wiha callipers prevent measuring surfaces from becoming soiled by metal filings, which could impair the accuracy of measurements. Since they are



The dialMax ESD calliper can be used for measuring delicate electronic components.

made of non-corrosive material, Wiha callipers can also be used in damp working environments.

With the Wiha dialMax ESD callipers, measuring at ESD workstations and in ESD protection zones is now possible for the first time.



The measuring jaw of the fibre-glass reinforced calliper enables scratch-free measurement of even very delicate, shiny surfaces.

- **Permanent**
  - very rigid with 50% fibre-glass component
- **High tech material**
  - non-metallic
  - non-corrosive
  - non-magnetic
  - minimum thermal conductivity
  - electrically insulating
  - resistant to chemicals
  - temperature resistant measuring surfaces: temporarily to 180°, permanently at 100-120°
- **Versatile applications**
  - highly sensitive measurement objects
  - electronic components
  - sensitive surfaces
  - model making and prototype production
  - food industry
  - ESD protective zones
- **Precise**
  - practical ratchet guarantees equally balanced clamping force of the measurement jaws



**digiMax and caliMax.**



**411 170 1** Digital calliper digiMax, reading 0.01 mm.  
Blister packed.

Material: Non-metallic high-tech material with 50% fibre-glass content.  
 Scale: 5-digit digital display with 7.5 mm numeral height for easy reading.  
 Reading: 0.01 mm as well as 0.0005 inch.  
 Standards: CE compliant.  
 Application: For outside, inside and depth measurements.  
 Extra: Switches off automatically after 5 minutes of non-use.  
 Zero setting possible in every position for quick comparison measurements. Battery with approx. 2-year service life included.

Order-No.				
29422	150	6	48	5



**411 320 3** Vernier calliper caliMax, reading 0.1 mm.  
Blister packed.

Material: Non-metallic high-tech material with 50% fibre-glass content.  
 Scale: Vernier for millimetre and inch display.  
 Reading: 0.1 mm as well as 1/64 inch.  
 Application: For outside, inside and depth measurements.  
 Extra: Almost parallax-free reading of the measurement value.  
 Vernier scale in green ensures a good contrast for simple reading.

Order-No.				
27083	150	6	45	10

**dialMax and dialMax ESD.**



**411 210 2** Analog calliper dialMax, reading 0.1 mm.  
Blister packed.

Material: Non-metallic high-tech material with 50% fibre-glass content.  
 Scale: Dial, diameter 35 mm.  
 Reading: 0.1 mm; 1 dial rotation represents 10 mm.  
 Application: For outside, inside and depth measurements.  
 Extra: Impact resistant dial can be recalibrated to zero.

Order-No.				
27082	150	6	45	5



**411 210 8** Dial calliper dialMax ESD, reading 0.1 mm.  
Blister packed.

Material: Calliper made of ESD-safe material.  
 Non-metallic high-tech material with 60% fibre-glass content.  
 Surface resistance  $10^6 - 10^9$  ohms.  
 Scale: Dial, diameter 35 mm.  
 Reading: 0.1 mm; 1 dial rotation represents 10 mm.  
 Standards: IEC 61340-5-1.  
 Application: For all work with electrostatically endangered components.  
 For outside, inside and depth measurements.  
 Extra: Measurements in ESD protection zones and at ESD workstations.  
 Impact resistant dial can be recalibrated to zero.

Order-No.				
31439	150	6	45	5

**Wiha Info**

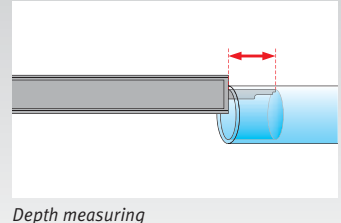
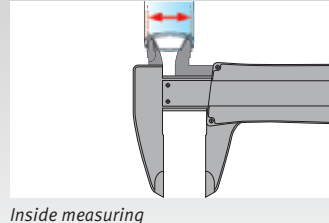
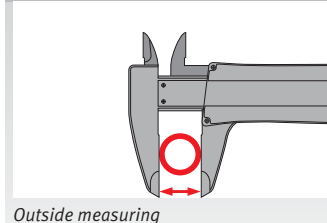

# Wiha Longlife® Plus Composite.

Maximum flexural strength.



**Wiha Longlife® Plus Composite.**

- **Extremely rigid!**
  - Absorbs bending forces
  - Minimises risk of breakage
- **Extremely durable!**
  - No swelling with water contact
  - Resistant against many chemicals
- **Lasts up to 10 times longer!**
  - Rigidity ensured by longitudinal glass fibres
  - Weatherproof and temperature-resistant plastic
  - Wear-resistant joints
  - Metal ends cannot be lost (protective function)

Longlife® Plus Composite redefines measuring with folding rulers. With a very high level of rigidity as known from high-grade beech wood rulers, this folding ruler

features increased measuring precision: precision class II has only been achieved until now by metal rulers and measuring tapes.

## LongLife Plus Composite



**NEW**

**410 2005** Longlife® Plus Composite, folding ruler, 2 m, 10 segments. With metal ends.

**Material:** Composite design: two top layers made of longitudinal glass fibres absorb bending forces and ensure more rigidity than wooden rules. No swelling with water contact, resistant to chemicals.

**Joints:** Play-free, wear-free and dirt-resistant joint with spring pin for constant tension. Tight 90° and 180° latching of all joints.

**Scale:** Red/black version: Deep-embossed white scale in 1 mm increments  
Grey/white version: Deep-embossed black scale in 1 mm increments, every 10 cm is marked in red

**Accuracy:** CE conformity, EU standard accuracy class II.

**Extra:** Metal ends which cannot be lost on the first and last segment. Readable from both sides through a second, backwards running scale (Recto Verso).



**NEW**

**410 ... VH** Sales counter display LongLife® Plus Composite folding rulers. Acrylglas displays with 20 pieces (2 m).

Order-No.				
37067	15	red/black	128	10
37309	15	grey/white	128	10

Order-No.	Content	Quantity
37145	410 2005 4	20 Longlife® Plus Composite, 2 m, red/black
37309	410 2005 5	20 Longlife® Plus Composite, 2 m, grey/white

# Wiha fibre-glass-reinforced folding rulers.

Perfection up to 2 m in length.



Often emulated but never surpassed – the Longlife Plus folding ruler: has a long service life and is accurate and easy to use.



The world's first folding ruler made of high-quality fibre-glass material was developed and manufactured in 1968, and since then has been successfully marketed under the "Longlife" name.

Its characteristic joint with perfect long-life characteristics is still unique today.

The Polyamide reinforced with 30% fibre-glass makes the Longlife® folding ruler water resistant and scratch and score-proof.

Compared to wooden folding rulers a substantially higher service life is attained.

A deep embossed, precise scale on every segment contributes to the excellent performance characteristics.



Joints



Metal ends



Backwards running scale



Fixation

Angular display

Angle gauge



Wiha fibre-glass-reinforced folding rulers.

- **Permanent – Longlife**
  - no swelling from contact with water!
  - distinctly longer service life compared to wooden folding ruler
  - resistant to chemicals, washable
- **Longlife Plus**
  - red joint bodies for improved legibility
  - wear-resistant metal ends
  - backwards running scale
- **Longlife All in One**
  - angle measurement function
  - depth measurement function
- **Exact**
  - CE conformity and Swiss precision for all rulers



# Wiha fibre-glass-reinforced folding rulers.

2 m of perfection.

## Longlife All in One and Longlife Plus. Displays.



### 410 2007 Longlife All in One folding ruler, 2 m metric, 10 segments.

**Material:** Glass fibre reinforced polyamide. Scratch, weather and chemical resistant.  
**Joints:** Play free, wear resistant and maintenance free joint with steel spring pin for constant tension. Usefull 90° snap-in position.  
**Scale:** Deep embossed black scale in 1 mm increments. Every 10 cm is marked in red.  
**Accuracy:** CE conformity, EU standard accuracy class III.  
**Extra:** Readable from both sides through a second, backwards running scale (Recto Verso).  
 Depth measurement with push-out depth gauge.  
 Angle measurement with anchoring of depth gauge in fixation hole.

Order-No.	↓	↔	↕	☰
33232	15	white	135	10



### 410 2001 Longlife Plus folding ruler, 2 m, metric, 10 segments. With metal ends.

**Material:** Glass fibre reinforced polyamide. Scratch, weather and chemical resistant.  
**Joints:** Play free, wear resistant and maintenance free joint with steel spring pin for constant tension. Usefull 90° snap-in position.  
**Scale:** Deep embossed black scale in 1 mm increments. Every 10 cm is marked in red.  
**Accuracy:** CE conformity, EU standard accuracy class III.  
**Extra:** Wear resistant metal ends on the first and last segments. Readable from both sides through a second, backwards running scale (Recto Verso).

Order-No.	↓	↔	↕	☰
27055	15	yellow	140	10
27059	15	white	140	10
27060	15	yellow/white	140	10

### 410 ... VH Sales counter display Longlife® folding rulers. Carton displays with 20 pcs. (2 m) or 54 pcs. (1 m).

Order-No.	Content	Quantity	
33660	410 2007 2	20	Longlife® All in One, 2 m
33945	410 2001 1	20	Longlife® Plus, 2 m, yellow
34495	410 2000 2	20	Longlife®, 2 m, white
33946	410 1000 2	54	Longlife®, 1 m, white

## Longlife.



### 410 2000 Longlife folding ruler, 2 m, metric, 10 segments.

**Material:** Glass fibre reinforced polyamide. Scratch, weather and chemical resistant.  
**Joints:** Play free, wear resistant and maintenance free joint with steel spring pin for constant tension. Usefull 90° snap-in position.  
**Scale:** Deep embossed black scale in 1 mm increments. Every 10 cm is marked in red.  
**Accuracy:** CE conformity, EU standard accuracy class III.

Order-No.	↓	↔	↕	☰
27058	15	yellow	140	10
27057	15	white	140	10



### 410 1000 Longlife folding ruler, 1 m, metric, 10 segments.

**Material:** Glass fibre reinforced polyamide. Scratch, weather and chemical resistant.  
**Joints:** Play free, wear resistant and maintenance free joint with steel spring pin for constant tension. Usefull 90° snap-in position.  
**Scale:** Deep embossed black scale in 1 mm increments. Every 10 cm is marked in red.  
**Accuracy:** CE conformity, EU standard accuracy class III.

Order-No.	↓	↔	↕	☰
27061	13	yellow	45	10
27062	13	white	45	10



### 410 1010 Longlife folding metre rule, 1 m, metric, 5 segments.

**Material:** Glass fibre reinforced polyamide. Scratch, weather and chemical resistant.  
**Joints:** Play free, wear resistant and maintenance free joint with steel spring pin for constant tension. Usefull 90° snap-in position.  
**Scale:** Deep embossed black scale in 1 mm increments. Every 10 cm is marked in red.  
**Accuracy:** CE conformity, EU standard accuracy class III.

Order-No.	↓	↔	↕	☰
27063	15	yellow	65	20



Sale only in pack quantities!  
 Special scales available on request.

# Wiha articulated hose system.

The universal pipe system.

**maxiflex**<sup>®</sup>



*The Wiha maxiflex<sup>®</sup> universal articulated hose system is dimensionally stable, individually adjustable and has a long service life.*



Wiha maxiflex<sup>®</sup> is a universal articulated hose system with maximum flexibility.

The broad range of hose joints, nozzles, connections, junctions and stop valves supply perfect solutions for every cooling or lubrication task.

A high quality and indestructible plastic, extensive design knowledge and precise manufacturing of all components ensures that this articulated hose system can be adapted for each individual application in day-to-day practice. With tight fitting components, maxiflex<sup>®</sup> is dimensionally stable, meaning no altering under pressure or via machine vibrations.

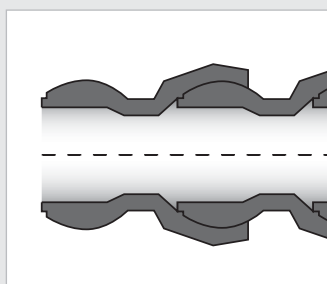

*Unrestricted flow design*

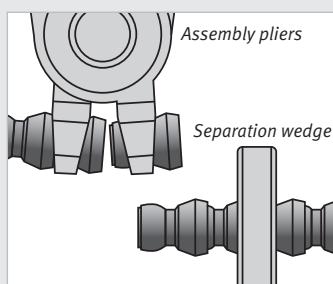

*Assembly pliers and separation wedge*



## Wiha articulated hose system.

### Permanent

- high quality, indestructible, dimensionally stable plastic
- resistant to chemicals and solvents
- is not an electrical conductor

### Universal use

- cooling and lubrication for sawing, drilling, milling, grinding and machining processes
- blowing out and drawing in of air
- conducting of solvents
- positioning of auxiliary aids (so-called third hands)

### Flexible

- adapter solutions for other hose systems

### Precise

- Swiss precision with articulated hose assortment



# Wiha articulated hose system.

The universal pipe system.























## maxiflex® programme ø 1/4" (6.35 mm).

	Order-No.	Article-No.	
	27085	412 2030	1
		<b>Pack with 22 segments, assembled</b>	
		Length: 280 mm	
	27086	412 2060	1
		<b>Pack with 80 segments, assembled</b>	
		Length: 1000 mm	
	27087	412 2220	1
		<b>Pack with 4 cylindrical nozzles ø 1.6 mm</b>	
	27088	412 2240	1
		<b>Pack with 4 cylindrical nozzles ø 3.2 mm</b>	
	27089	412 2260	1
		<b>Pack with 4 cylindrical nozzles ø 5.6 mm</b>	
	27090	412 2280	1
		<b>Pack with 2 flat nozzles, 7 holes (ø 1.5 mm)</b>	
		24 mm wide	
	27091	412 2330	1
		<b>Pack with 2 flat nozzles</b>	
		24 mm wide	
	27092	412 2420	1
		<b>Pack with 4 angular nozzles ø 1.6 mm</b>	
	27093	412 2440	1
		<b>Pack with 4 angular nozzles ø 3.2 mm</b>	
	27094	412 2460	1
		<b>Pack with 4 angular nozzles ø 5.6 mm</b>	
	27095	412 2480	1
		<b>Pack with 2 multi-hole angular nozzles, 7 holes (ø 2 mm)</b>	
	27096	412 2640	1
		<b>Pack with 4 adapters for LOC-LINE®</b>	
		Flexi and ARIANA Cool-Line	
	27097	412 2650	1
		<b>Pack with 4 spherical double socket segments</b>	
	27098	412 2660	1
		<b>Pack with 4 double nipples</b>	
	27099	412 2710	1
		<b>Pack with 4 threaded nipples R 1/8"</b>	
	27100	412 2720	1
		<b>Pack with 4 threaded nipples R 1/4"</b>	
	27101	412 2740	1
		<b>Pack with 2 Y-junctions</b>	
	27102	412 2770	1
		<b>Pack with 2 regulating valves</b>	
	27103	412 2780	1
		<b>Pack with 2 segment clips</b>	
	28006	412 2020	1
		<b>6 short nozzles, assembled, with:</b>	
		1 threaded nipple R 1/8"	
		1 segment	
		1 short cylindrical nozzle ø 2.5 mm	
	29446	412 2760	1
		<b>Ball valve with threaded outlet G 1/4"</b>	







## maxiflex® programme ø 1/4" (6.35 mm).

	Order-No.	Article-No.	
	27084	412 2010	1
		<b>maxiflex®-set, assembled</b>	
		1 threaded nipple R 1/4"	
		22 segments	
		1 cylindrical nozzle ø 3.2 mm	
		Total length: 320 mm	
	27108	412 2920	1
		<b>Separation wedge</b>	
	27109	412 2930	1
		<b>Assembly pliers</b>	
	27104	412 2810	1
		<b>Set with magnetic foot and ball valve, assembled</b>	
		1 threaded nipple R 1/4"	
		22 segments	
		1 cylindrical nozzle ø 3.2 mm	
		Magnetic foot with hose nozzle ø 11 mm	
Extra:		Magnetic adhesion 80 N	
	27105	412 2820	1
		<b>Set with magnetic foot, assembled</b>	
		2 threaded nipples R 1/4"	
		44 segments, length: 2 x 320 mm	
		2 cylindrical nozzles ø 3.2 mm	
		Magnetic foot with hose nozzle ø 11 mm	
Extra:		Magnetic adhesion 80 N	
	27106	412 2830	1
		<b>Set with magnetic foot and ball valve, assembled</b>	
		1 threaded nipple R 3/8" for hose diameter 1/2"	
		1 reduction of hose diameter from 1/2" to 1/4"	
		22 segments	
		1 cylindrical nozzle ø 3.2 mm	
		Magnetic foot with hose nozzle ø 11 mm	
Extra:		Magnetic adhesion 150 N	
	27107	412 2850	1
		<b>Distribution block with 3 ball valves</b>	
		Ball valves with threaded outlets R 1/4"	
		Hose nozzle ø 11 mm	
Extra:		Magnetic adhesion 4 x 95 N	
	30518	412 2000	1
		<b>maxiflex® basic set</b>	
		3 tubes à 280 mm	
		2 cylindrical nozzles ø 1.6 mm	
		3 cylindrical nozzles ø 3.2 mm	
		2 cylindrical nozzles ø 5.6 mm	
		1 flat nozzle 24 mm	
		1 flat nozzle 24 mm, 7 holes ø 1.5 mm	
		2 Y-junctions	
		1 spherical double socket segment	
		2 threaded nipples R 1/8"	
		3 threaded nipples R 1/4"	
		1 adapter for LOC-LINE®	
		1 assembly pliers	
		1 separation wedge	

## maxiflex® programme ø 1/2" (12.7 mm).

	Order-No.	Article-No.	
	27111	412 4030	1
		<b>Pack with 12 segments, assembled</b>	
		Length: 265 mm	
	27112	412 4060	1
		<b>Pack with 48 segments, assembled</b>	
		Length: 1000 mm	
	27113	412 4130	1
		<b>Pack with 4 jointed pipe segments</b>	
		Length: 440 mm	
	27114	412 4160	1
		<b>Pack with 4 segment clamps incl. screws</b>	
	27115	412 4220	1
		<b>Pack with 4 cylindrical nozzles ø 10 mm</b>	
	27116	412 4240	1
		<b>Pack with 2 flat nozzles, 6 holes (ø 10 mm)</b>	
		30 mm wide	
	27117	412 4330	1
		<b>Pack with 2 flat nozzles 30 mm wide</b>	
	27118	412 4360	1
		<b>Pack with 2 flat nozzles 60 mm wide</b>	
	27119	412 4420	1
		<b>Pack with 4 angular nozzles ø 7 mm</b>	
	27120	412 4440	1
		<b>Pack with 4 angular nozzles ø 10 mm</b>	
	27121	412 4460	1
		<b>Pack with 2 multi-hole angular nozzles,</b>	
		8 holes (ø 3.5 mm)	
	27122	412 4620	1
		<b>Pack with 2 reducers,</b>	
		1/2" to 1/4" system	
	27123	412 4640	1
		<b>Pack with 4 adapters for Loc-Line® Flexi</b>	
		<b>and ARIANA Cool-Line</b>	
	27124	412 4650	1
		<b>Pack with 4 spherical double socket</b>	
		segments	
	27125	412 4660	1
		<b>Pack with 4 double nipples</b>	
	27126	412 4720	1
		<b>Pack with 4 threaded nipples R 3/8"</b>	
	27127	412 4730	1
		<b>Pack with 4 threaded nipples R 1/2"</b>	
	27128	412 4740	1
		<b>Pack with 2 Y-junctions</b>	
	27129	412 4750	1
		<b>Pack with 2 Y reducer junctions</b>	
		1/2" to 1/4" system	
	27130	412 4770	1
		<b>Pack with 2 regulating valves</b>	
	27131	412 4780	1
		<b>Pack with 2 segment clips</b>	

## maxiflex® programme ø 1/2" (12.7 mm).

	Order-No.	Article-No.	
	29447	412 4760	1
		<b>Ball valve with</b>	
		threaded outlet G 3/8"	
	27110	412 4010	1
		<b>maxiflex®-set, assembled</b>	
		1 threaded nipple R 1/2"	
		12 segments	
		1 cylindrical nozzle ø 10 mm	
		Total length: 320 mm	
	27134	412 4920	1
		<b>Separation wedge</b>	
	27135	412 4930	1
		<b>Assembly pliers</b>	
	27132	412 4820	1
		<b>Set with magnetic foot and ball valve,</b>	
		assembled	
		1 threaded nipple R 3/8"	
		12 segments	
		1 cylindrical nozzle ø 10 mm	
		Magnetic foot with hose nozzle ø 13 mm	
	Extra:	Magnetic adhesion 150 N	
	27133	412 4860	1
		<b>Distribution block with 3 ball valves</b>	
		Ball valve with threaded outlet R 3/8"	
	Extra:	Magnetic adhesion 4 x 95 N	
	30519	412 4000	1
		<b>maxiflex® basic set</b>	
		3 tubes à 265 mm	
		3 cylindrical nozzles ø 10 mm	
		1 flat nozzle 30 mm	
		1 flat nozzle 60 mm	
		1 flat nozzle 30 mm, 6 holes ø 3.3 mm	
		1 Y-junction	
		1 Y reducer junction	
		1 reduction of hose	
		diameter from 1/2" to 1/4"	
		3 threaded nipples R 1/2"	
		2 threaded nipples R 3/8"	
		1 adapter for LOC-LINE®	
		1 assembly pliers	
		1 separation wedge	













## Wiha Info

**You currently use a different system?  
No problem!**













System	Information
LOC-LINE®	Compatible with help of maxiflex® adapter order no. 27096 (1/4") and 27123 (1/2").
Snap-Loc®	Compatible on both sides (external and internal ball) without adapter.
ARIANA Cool-Line	Compatible with help of maxiflex® adapter order no. 27096 (1/4") and 27123 (1/2").
LEGROM-VARIO-System®	Small version 1/4" is compatible with help of maxiflex adapter (order no. 27096) when using Varios outer ball and adapters inner ball.

# How to find the correct tip?



														
SoftFinish® screwdrivers	15 22-23	16 22-23		16 22-23		18-19 24	19	19	20	21 25		21	20	
SoftFinish® Screw-holding screwdrivers	15	16												
SoftFinish® with mm scale SoftFinish® Stubbys	17 18	17 18		17 18										
MicroFinish® screwdrivers	27 29	27 29		28 29		28				28				
Classic screwdrivers	31-32	31 32		31 32		31			32	32				
Pocket screwdrivers	33													
Wooden handle screwdrivers	35	35		35										
PicoFinish screwdrivers	37 40	37 40		37		37 41	38	38	38 39	39 41				
SoftFinish® electric slimFix screwdrivers	51-53	51-53	51	51-53	51-53	51 53					51			
Magazine bit holder LiftUp electric	55	55			55									
SoftFinish® electric slimVario screwdrivers	57-60	57-60	57	57-58 60	57-59	57-60					57 58			
SoftFinish® electric screwdrivers	61 63	62 63	65	62 63	65	62			62	62 63	62			
Topra 2K electric						67			67	67				
Classic electric screwdrivers	68	68												
PicoFinish electric screwdrivers	69	69												
Voltage testers	71													
SoftFinish® ESD screwdrivers	73 74	73 74		73		74								
SoftFinish® ESD Stubbys	73	73		73										
Precision ESD screwdrivers	76	76		76		77		77	76	76				
Ceramic screwdrivers	79	79												

														
SYSTEM 6	112, 114-117	112/114 116-117		112, 114-117		112, 114-117	113/115		112, 114-117	112-113, 115		113/115	113/115	
SYSTEM 4	119/ 121-123	119/ 121-123		119		120-123			120-123	120				
Torque screwdrivers	90	88/90		88/90		88/91		88/91	88/90					
Torque VDE screwdrivers	94 96-97	94-97	94	94-97	93/94 96/97	94/96			94/95		95			
Torque ESD screwdrivers	99	99		99		99								
Torque T-handle						103-104 107		103/107	103/107					
Torque T-handle VDE						105			105	105				



**L-keys**

**ErgoStar holder**

**ProStar holder**

**Compact holder**

**Classic holder**

**PocketStar® holder**











**ComfortGrip T-handle**

**Classic T-handle**

**Key handle**

**Flag handle**

**Offset screwdriver**

															
L-keys				149-157	157	151, 157	131-147			145	156				
ErgoStar holder			149, 153			131, 133, 135									
ProStar holder			150, 153-155				134-138 140-141								
Compact holder							139, 141-144	146-147							
Classic holder			150/153, 155-156	157	151, 157	136, 139-147									
PocketStar® holder	160-162	160-162		160-162	161		159-162								
ComfortGrip T-handle				165			164-165								
Classic T-handle				170		170	167-169	168-169	168						
Key handle				172		172	172								
Flag handle				173		173									
Offset screwdriver	173	173	173												



**MaxxTor-bits**

**DuraBits**

**Diamond torsions bits**

**Torsions bits**

**Inkra bits**

**Standard bits**

**Stainless steel bits**

**Professional bits**

**Industrial bits**



**Bits with MagicRing®**

**Threaded bits**

**Bits for drive system C 4**

**Bits for drive system C 8 5/16"**

**Bits for drive system G 7**

																
MaxxTor-bits		177		177		177			177	177						
DuraBits	179	179		179		179										
Diamond torsions bits	181	181		181		181										
Torsions bits	183/185	183/185		183/185		183/185						186				
Inkra bits		187		187												
Standard bits	189	189		189		190	190	190	191	192	192			192		
Stainless steel bits	193	193		193		193										
Professional bits	195	195	195	195	195	196	196	196	196	197						
Industrial bits		199				199		199	199	199						
Bits with MagicRing®										198						
Threaded bits		200		200		200										
Bits for drive system C 4	202	202				202				202						
Bits for drive system C 8 5/16"	204	204		204		204				204						
Bits for drive system G 7		204		204												

# Wiha VDE tools.

VDE in detail.

## Wiha Info

### What is VDE?

The VDE Testing and Certification Institute is a nationally and internationally accredited institution in the field of testing and certification of electrical engineering devices, components and systems. These electrical products are tested for safety, electromagnetic compatibility and other product properties.



### VDE-GS Mark

Technical working equipment and consumable materials subject to the applicable device and product safety laws bear the VDE-GS mark, which stands for the safety of the product with regard to electrical, mechanical, thermal, toxicological, radiological and other dangers.

In addition, tools with the VDE-GS mark conform to the VDE regulations or European or internationally harmonised standards, i.e. they confirm the compliance with the safety requirements of the respective guidelines.



### Double triangle and voltage range

If insulated tools or aids are marked with the symbol of the double triangle and the assigned voltage or voltage range specification or the class, they are suitable for working on energised parts.



### IEC 60900:2012

An international standard which, among other things, describes the design of insulated tools in detail. For example, the thickness of the protective insulation is specified. In addition, the standard defines individual tests (piece tests) as well as series and random sample tests for checking the electrical safety of the protective insulation.



Wiha VDE tools are subjected to extremely demanding safety test methods.



## Safety test method according to IEC using the example of a pair of Wiha pliers



### Voltage test (piece test)

Wiha VDE tools are tested individually. All tools with the special marking were tested with 10,000 V AC and are therefore approved for 1,000 V AC (and 1,500 V DC). This means: ten-fold safety.



### Cold shock test

The tools are cooled down to -25 °C. The insulating material must retain its toughness in the process so that it does not break when subjected to impacts and jolts.



### Testing the electrical insulating properties

The tools are stored in water for 24 hours. Then they are tested at 10,000 V AC for three minutes. Neither a sparkover nor a disruptive discharge through the insulation may occur.



### Testing the adhesion of the insulating material coating

To test the adhesion of the insulating coating, the adhesion is tested with a tensile force of 500 N following storage for 168 hours at 70° C. When doing so, the insulating material must continue to be firmly connected to the basic tool.



### Pressure tests

No disruptive discharge may occur at a pressure load of 20 N, a temperature of 70° C and a test voltage of 5,000 V AC.



### Testing the combustion behaviour

A flame is pointed at the tool for ten seconds. The insulating material may then not continue to burn, but instead must extinguish.



## Protective measures

For all work on or near live parts, use the following required for the respective work

- insulating personal safety equipment,
- insulating safety equipment and
- insulated tools.

Work should generally not be carried out on live active parts of electrical systems and electrical equipment. As a result, the parts must be deenergised before starting work and this state must be ensured for the duration of the work.

This is done by complying with the five safety rules.

### Before beginning work:

- Isolate
- Protect against being switched on again
- Determine deenergised state
- Earth and short-circuit
- Cover or block access to neighbouring live parts.

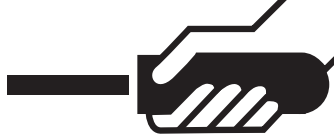

# It all fits together...

## DIN screwdrivers

Torque test		Slotted screws											Self tapping screws					Wood screws		
		Metric screws					Set						Flat head		Oval head			Pan head		
		Flat head	Oval head	Cheese head	Pan head		Flat head	Oval head	Pan head	Flat head	Oval head	Pan head	Flat head	Oval head	Round head					
ISO 2380	ISO 2009	ISO 2010	ISO 1207	ISO 1580		ISO 4766	ISO 7435	ISO 1482	ISO 1483		ISO 1481									
	DIN 963	DIN 964	DIN 84	DIN 85	DIN 920	DIN 921	DIN 551	DIN 427	DIN 7972	DIN 7973	DIN 7971	DIN 97	DIN 95	DIN 96						
Size	Nm	M	M	M	M	M	M	M	M	M	M	B	B	B	B	B	H	H	H	
2 x 0,4	0,30							2,5	2,5								1,6		1,6	
2,5 x 0,4	0,40	1,6	1,6	1,6	1,6	1,6	1,8	1,6	2,5	1,6	3,5	3,5						1,6	2	
3 x 0,5	0,7	2	2	2	2	2	2	3/3,5	2	4	4	2,2	2,2	2,2	2,2	2,2	2	2		
3,5 x 0,6	1,3	2,5	2,5	2,5	2,5	2,5	2,5	4	2,5								2,2	2,5	2,5	2,5
4 x 0,8	2,6	3	3	3	3	3	3	5	3	5	5	2,9	2,9	2,9	2,9	2,9	2,9	3	3	3
5,5 x 1	5,5	3,5	4	3,5	4	3,5	4	3,5	3,5	6	4						3,5	4	4	4
6,5 x 1,2	9,4	4	5	4	5	4	4					8	8	4,2	4,2	4,2	4,2	5	5	5
8 x 1,2	11,5					5	5	4	4	8	5					4,8	4,2	4,2	5,5	5,5
8 x 1,6	20,5	6	6	6	6							10	10	5,5	5,5	5,5	5,5	6	6	6
10 x 1,6	25,6					6	6	6	6	10	6		14			6,3	5,5	5,5	7	7
12 x 2	48,0	8	8	8	8	8	8	8	8			16	8		8		6,3	6,3	8	
14 x 2,5	87,5	10	10	10	10	10	10	10	10			18-20	9,5		9,5				10	

Torque test		Phillips + Pozidriv									ANSI screws		Index			
		Metric screws			Self tapping screws			Wood screws								
		Flat head	Oval head	Pan head	Pan head	Flat head	Oval head	Oval head	Round head	Flat head						
ISO 8764	ISO 7046	ISO 7047	ISO 7045	ISO 7049	ISO 7050	ISO 7051										
	DIN 965	DIN 966	DIN 7985	DIN 7981	DIN 7982	DIN 7983	DIN 7995	DIN 7996	DIN 7997							
Size	Nm	M	M	M	B	B	B	H	H	H	Nr.					
00	00	*	*	*	*	*	*	*	*	*						
0	0	1	1,6	1,6	1,6	2	2	2	2	2	0 - 1					
1	1	3,5	2,5	2,5	2	2,2	2,2	2,2	2,5	2,5	2 - 4					
2	2	8,2	3	3	3	2,9	2,9	2,9	3	3						
3	3	19,5	3,5	3,5	3,5	3,5	3,5	3,5	3,5	3,5	5 - 10					
4	4	38	5	5	5	4,8	4,8	4,8	5	5						
			6	6	6	5,5	5,5	5,5	5,5	5,5	12 - 16					
			8	8	8	6,3	6,3	6,3	7	7						
			10	10	10				8	8	18 - ...					

\* Special screws

TORX® screwdrivers

TORX® nut drivers

				Internal TORX®											
				Metric screws						Self tapping screws					
				Cheese head	Flat head	Oval head	Cheese head	Oval head	Flat head	Pan head	Flat head	Oval head			
				ISO 4762	ISO 7046	ISO 7047 2010		ISO 7045	ISO 10642	ISO 7049	ISO 7050	ISO 7051			
				DIN 912	DIN 963 965	DIN 964 966	DIN 7984 6912	DIN 7985	DIN 7991	DIN 7981 7982	DIN 7972 7983	DIN 7973			
Torque test				M $\times$ mm	M $\times$ mm	M $\times$ mm	M $\times$ mm	M $\times$ mm	M $\times$ mm	B $\times$ mm	B $\times$ mm	B $\times$ mm			
Size 1:1	TORX®	mm	Nm												
	T 5	1,42	0,43	*	*	*	*	*	*	*	*	*			
	T 6	1,70	0,75	2	*	2	*	2	*	2,2	2,2	2,2			
	T 7	1,99	1,4	*	*	*	*	*	*	*	*	*			
	T 8	2,31	2,2	2,5	2,5	2,5		2,5		2,9	2,9				
	T 9	2,50	2,8												
	T 10	2,74	3,7	3	3	3	3	3	3	3,5	3,5	2,9			
	T 15	3,27	6,4		3,5	3,5		3,5	4	3,9	3,9	3,5			
	T 20	3,86	10,5	4	4	4	4	4	5	4,2	4,2	4,2			
	T 25	4,43	15,9	5	5	5		5	6	4,8 5,5	4,8 5,5	4,8 5,5			
	T 27	4,99	22,5	**	**	**	**	**	**	**	**	**			
	T 30	5,52	31,1	6	6	6	6	6		6,3	6,3	6,3			
	T 40	6,65	54,1		8				8			8			
	T 45	7,82	86	8	**	8	8	8	**	**	**	**			
	T 50	8,83	132	10	10	10	10	10	10			9,5			
	T 55	11,22	218	12			12								
	T 60	13,25	379	14			14								

  

				External TORX®		
				Metric screws		
				Flange	Flange	
				ISO 4014 4017	ISO 8100	
				DIN 931 933	DIN 6921	
Size 1:1	TORX®	mm		M $\times$ mm	M $\times$ mm	
	E 4	3,83		3		
	E 5	4,72		4		
	E 6	5,69		5	4	
	E 7	6,17		**	**	
	E 8	7,47		6	5	
	E 10	9,37		8	6	
	E 12	11,12		10	8	
	E 14	12,85		12	10	
	E 16	14,71		**	**	
	E 18	16,64		14	12	
	E 20	18,41		16	14	

\* Screws for tungsten carbide inserts

\*\* Special screws

TORX® and TORX PLUS® are registered trademarks of Camcar, Div. of Textron Inc.

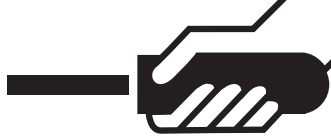

# It all fits together...

## DIN hex keys

## DIN nut drivers

Torque test	Hex sockets						
	Metric screws						
	Cheese head	with pivot	Cheese head	Flat head	Set		
	ISO 2936	ISO 4762		ISO 10642	ISO 4026 4029	ISO 4027	ISO 4028
	DIN 912	DIN 6912	DIN 7984	DIN 7991	DIN 913 916	DIN 914	DIN 915
Nm							
0,7	0,08				1,4 1,6 1,8	1,4 1,6 1,8	1,4 1,6 1,8
0,9	0,18				2	2	2
1,3	0,53	1,4			2,5	2,5	2,5
1,5	0,82	1,6-2			3	3	3
2	1,9	2,5		3	4	4	4
2,5	3,8	3		4	5	5	5
3	6,6	4	4	5	6	6	6
4	16	5	5	6	8	8	8
5	30	6	6	8	10	10	10
6	52	8	8		12 14	12 14	12 14
7	78			10			
8	120	10	10	12	16	16	16
10	220	12	12	14	18 20	18 20	18 20
12	370	14	14	16 18	22 24	22 24	22 24
14	590	16 18	16 18	20 22 24			
17	1000	20 22	20 22	24			
19	1000	24 27	24 27				
22	1000	30	30				
24	1000	33	33				
27	1000	36	36				
32	1000	42					

Torque test	Hex heads							
	Metric screws and nuts						Screws	
	Screws				Nuts		Self tapping	Wood screws
	ISO 8100	ISO 4016	ISO 4014	ISO 4017	ISO 4035 4036	ISO 4032 4033	ISO 1479	
	DIN 6921	DIN 601	DIN 931	DIN 933	DIN 439	DIN 934	DIN 7976	DIN 571
Nm								
2,5							1	
3							1,2 1,4	
3,2			1,6	1,6	1,6	1,6	2,2	
3,5					1,8			
4			2	2	2	2		
4,5				2,3				
5			2,5	2,5	2,5	2,5	2,9	
5,5			3	3	3	3	3,5	
6			3,5	3,5	3,5	3,5		
7			4	4	4	4	3,9 4,2	4
8	16,6	5	5	5	5	5	4,8 5,5	5
9	23,0							
10	31,0	6	6	6	6	6	6,3	6
11	40,4			7	7			
12	51,5							7
13	64,5	8	8	8	8	8	8	8
14	79,4							
15	96,2							
16	115	10	10	10	10	10		
17	134	10	10	10	10	10		10

Inch = mm	Inch = mm
1/16 = 1,59	9/32 = 7,14
5/64 = 1,98	5/16 = 7,94
3/32 = 2,38	11/32 = 8,73
7/64 = 2,78	3/8 = 9,53
1/8 = 3,18	7/16 = 11,11
9/64 = 3,57	1/2 = 12,70
5/32 = 3,97	9/16 = 14,29
3/16 = 4,76	5/8 = 15,88
7/32 = 5,56	3/4 = 19,05
1/4 = 6,35	

Torque test	Square head				
	Metric screws			Metric nuts	
	DIN 478	DIN 479	DIN 480	DIN 557	DIN 562
	M	M	M	M	M
3,5					1,8
4					2
4,5					
5	5	5			2,5
5,5					3
6	6	6			3,5
7					4
8	8	8	8	5	5
9					
10	10	10	10	6	6
11					
12					
13	12	12	12	8	8
14					



# It all fits together...

## DIN screwdriver sockets

Torque test		Slotted screws																						
		Metric screws											Self tapping screws						Wood screws					
		Flat head		Oval head		Cheese head		Pan head			Set		Flat head		Oval head		Pan head		Flat head	Oval head	Round head			
ISO 2351		ISO 2009	ISO 2010	ISO 1207	ISO 1580						ISO 4766 7435	ISO 7435	ISO 1482	ISO 1483	ISO 1481									
Nm		DIN 963	DIN 964	DIN 84	DIN 85	DIN 920	DIN 921	DIN 551 417	DIN 427	DIN 7972	DIN 7973	DIN 7971	DIN 97	DIN 95	DIN 96									
2 x 0,4	0,35											2,5 3	3											
2,5 x 0,4	0,42	1,6	1,6	1,6	1,6	1,6	1,6	1,6	2,5	1,6	3,5 3	3,5 4										1,6	1,6	1,6
3 x 0,5	0,8	2	2	2	2	2	2	2	3		4		2,2	2,2	2,2		2,2					2	2	2
4 x 0,5	1,1								3	2														
3,5 x 0,6	1,4	2,5	2,5	2,5	2,5	2,5						5					2,2		2,2	2,5	2,5			
4,5 x 0,6	1,8					2,5	2,5		4	2,5														2,5
4 x 0,8	2,9	3	3	3	3	3		3			5 6	6	2,9	2,9	2,9	2,9	2,9					3	3	
5,5 x 0,8	3,9		3,5		3,5		3	3,5	3	5	3										2,9	3,5	3,5	3,5
5,5 x 1	6,2	3,5	4	3,5	4	3,5	4	3,5	4	6	4		8	3,5	3,5	3,5	3,5	3,5	3,5	3,5	3,5	4	4	4
6,5 x 1,2	10,5	4		4		4		4			8	10	4,2	4,2	4,2	4,2								
8 x 1,2	12,9	5	5	5	5	5	5	5	8	5			4,8	4,8	4,8	4,8	4,2	4,2	4,2	4,2	5,5	5,5	5	5
8 x 1,6	22,9					6					10 12	(12)	5,5	5,5	5,5									
10 x 1,6	28,7	6	6	6	6		6	6	10	6		(14)	6,3	6,3	6,3	6,3	5,5	5,5	6,3	6,3	7	7	6	6
12 x 2	53,8	8	8	8	8	8	8	8		8		(16)	8		8		8				8	8	7-8	7-8
14 x 2,5	98,0	10	10	10	10	10	10	10	10	10		(18-20)	9,5		9,5		9,5				10			

Torque test		Phillips and Pozidriv screws											ANSI screws
		Metric screws					Self tapping screws			Wood screws			
		Flat head		Oval head	Oval head	Oval head	Oval head	Flat head	Oval head	Oval head	Round head	Flat head	
ISO 8764		ISO 7046	ISO 7047	ISO 7045	ISO 7049	ISO 7050	ISO 7051						
Nm		DIN 965	DIN 966	DIN 7985	DIN 7981	DIN 7982	DIN 7983	DIN 7995	DIN 7996	DIN 7997			
00	00	*	*	*	*	*	*	*	*	*	*	No.	
0	0	1	1,6	1,6	1,6	2,2	2,2	2,2	2	2	2	0-1	
1	1	3,9	1,8	1,8	1,8	2,2	2,2	2,2	2	2	2	2-4	
			2	2	2								
			2,5	2,5	2				2,5	3			
2	2	10,3	3	3	3	2,9	2,9	2,9	3	3	3	5-10	
			3,5	3,5	3,5								
			4	4	4				3,9	3,9	3,9		
3	3	32	5	5	5	4,2	4,2	4,2	4	4	4	12-16	
			4,8	4,8	4,8								
			5	5	5				4,5	4,5	4,5		
4	4	88,7	6	6	6	5,5	5,5	5,5	5	5	5	18-...	
			6	6	6								
			6,3	6,3	6,3				6	6	6		
			8	8	8	8	8	8	7	7	7		
			8	8	8								
			8	8	8				8	8	8		
			10	10	10	9,5	9,5	9,5	8	8	8		
			9,5	9,5	9,5								
			9,5	9,5	9,5				9,5	9,5	9,5		

\* Special screws





# It all fits together...

## TORX® screwdriver sockets

				Internal TORX®								
				Metric screws						Self tapping screws		
				Cheese head	Flat head	Oval head	Cheese head	Oval head	Flat head	Pan head	Flat head	Oval head
				ISO 4762	ISO 7046	ISO 7047 2010		ISO 7045	ISO 10642	ISO 7049	ISO 7050	ISO 7051
				DIN 912	DIN 963 965	DIN 964 966	DIN 7984 6912	DIN 7985	DIN 7991	DIN 7981	DIN 7972 7982	DIN 7973 7983
Torque test												
Size 1:1	TORX® Size	mm	Nm	M	M	M	M	M	M	B	B	B
	T 5	1,42	0,51	*	*	*	*	*	*	*	*	*
	T 6	1,70	0,9	*	2	*	*	*	*	*	2,2	*
	T 7	1,99	1,7	*	*	*	*	*	*	*	*	*
	T 8	2,31	2,6	2,5	2,5	2,5		2,5		2,9	2,9	2,9
	T 9	2,50	3,4									
	T 10	2,74	4,5	3	3	3	3	3	3	3,5	3,5	3,5
	T 15	3,27	7,7		3,5	3,5		3,5		3,9	3,9	3,9
	T 20	3,86	12,7	4	4	4	4	4	4	4,2	4,2	4,2
	T 25	4,43	19,0	5	5	5	5	5	5	4,8 5,5	4,8 5,5	4,8 5,5
	T 27	4,99	26,9	**	**	**	**	**	**	**	**	**
	T 30	5,52	37,4	6	6	6	6	6	6	6,3	6,3	6,3
	T 40	6,65	65,1		8				8			
	T 45	7,82	104	8	**	8	8	8	**	**	**	**
	T 50	8,83	159	10	10	10	10	10	10			
	T 55	11,22	257	12			12					
	T 60	13,25	446	14			14					

\* Screws for tungsten carbide inserts

\*\* Special screws

TORX® and TORX PLUS® are registered trademarks of Camcar, Div. of Textron Inc.

### DIN screwdriver sockets

### DIN nut drivers

		Hex sockets									Hex heads							
		Metric screws									Metric screws and nuts				Screws			
		Cheese head	with pivot	Cheese head	Flat head	Set				Screws				Nuts		Self tapping	Wood screws	
Torque test		ISO 4762			ISO 10642	ISO 4026	ISO 4027	ISO 4028	ISO 1711	ISO 8100	ISO 4016	ISO 4014	ISO 4017	ISO 4035	ISO 4032	ISO 1479		
		DIN 7426	DIN 912	DIN 6912	DIN 7984	DIN 7991	DIN 913	DIN 914	DIN 915		DIN 6921	DIN 601	DIN 931	DIN 933	DIN 439	DIN 934	DIN 7976	DIN 571
		Nm							Nm									
SW																		
0,7						1,4	1,4	1,4										
						1,6	1,6	1,6										
						1,8	1,8	1,8										
						2	2	2	3									
						2,5	2,5	2,5	3,2	7,08		1,6	1,6	1,6	1,6	2,2		
						3	3	3	3,5	8,26				1,8				
	0,95	1,6-2				4	4	4	4	10,4			2	2	2	2		
	2,3	2,5		3	3	5	5	5	4,5	12,6			2,3					
	4,4	3		4	4	6	6	6	5	15,1			2,5	2,5	2,5	2,5	2,9	
	7,6	4	4	5	5	8	8	8	5,5	17,8			3	3	3	3	3,5	
	18	5	5	6	6	10	10	10	6	20,6			3,5	3,5	3,5	3,5		
	35	6	6	8	8	12	12	12	7	26,8			4	4	4	4	3,9	4
	61	8	8		10	14	14	14	8	33,6	5	5	5	5	5	5	4,8	5
	97			10					9	41,1							5,5	
	140	10	10	12	12	16	16	16	10	49,1	6	6	6	6	6	6	6,3	6
	280	12	12	14	14	18	18	18	11	57,8			7	7		7		
					16	20	20	20	12	67,0								7
	480	14	14	16	18	22	22	22	13	68,6	8	8	8	8	8	8	8	8
				18	20	24	24	24	14	68,6								

#### Index

ISO International standard

DIN German standard

Metric screws Thread diameter

Set screw metric Thread diameter

Metric nut Thread diameter

Self tapping screws Thread diameter

Wood screws Thread diameter

#### Symbole

Tool drive = screwdriver socket

for screws with internal drive

Tool drive = Nutdriver socket

for screws with head drive

# Innovation

We break new ground.



*Innovative ideas and actions are the driving force behind our success.*

## The innovation of our employees

We regard innovation as an important basis if we are to meet the ever changing market requirements. We create this basis by giving our employees the freedom to act upon their own initiative within the existing, flat hierarchical structure of the company.

In this way, we can operate in a more targeted and individual manner in order to fulfil your wishes and requirements.

## The innovation of our processes

Process optimisation ultimately delivers the greatest benefits for you. By putting new innovations into practice, we are able to improve and automate manufacturing and production methods. Process optimisation enables us to reduce manufacturing costs without compromising on the quality of our products.

In this way, we can guarantee you lower costs and faster processing.

## The innovation of our products

We break new ground. Particularly today when market requirements are changing at an ever more rapid pace, we understand that our challenge is to meet these requirements. Product innovation represents both the basis and the result of our endeavours. This is manifested in numerous patents and unique selling points.

We believe in our own innovative strength. We also want to do justice to you.

## 100% innovation

- We are directly responsible for our work and have the necessary freedoms to be able to transform your requirements into specific solutions.
- With the help of new manufacturing methods and machines, we realise new ideas in order to offer you high-quality products.
- Process optimisation improves the processing channels and enables us to act more quickly.
- In all areas, innovation forms the basis for meeting your requirements and for penetrating new markets. This is our challenge.
- Our employees create the basis for our innovations.



# Quality

Quality starts with the very first contact.



*Our employees deliver high-quality products and services on a daily basis.*



## The quality of our employees

Quality starts with the very first contact. For us, quality means more than just product quality. First and foremost, the quality of our employees establishes the basis for the high quality of our products. This is achieved by means of teams of employees working independently and with direct responsibility.

Ongoing education and support strengthen the commitment and qualification of our employees. Our employees are skilled professionals in whom you will be happy to place your trust.

We should like to impress you with our service competence.

## The quality of our processes

Optimisation of the company work processes is another basic principle.

In order to be able to process your requests/wishes competently and more quickly, we work according to strict goals and objectives. Our processes are checked, re-selected and optimised systematically so as to increase quality even more. By means of the highest possible readiness to deliver and a comprehensive service, we guarantee your full satisfaction.

## The quality of our products

Our products are characterised by maximum quality, mature function and innovative design.

We guarantee this claim by using only carefully selected materials and by making ongoing improvements to the quality guidelines.

Find out for yourself and benefit from our professional expertise.



Wiha tools are manufactured to the highest standards. Many years of cooperation with the licensors for TORX®, TORX PLUS®, ACR/AOT, Tri-Wing®, Torq-Set® and Pozidriv give you maximum fitting accuracy of fastening tools in screw heads. True to our motto: Wiha – premium tools.

## 100% quality

- Independent work as part of a team, with each team player carrying direct responsibility, increases our flexibility and commitment.
- Our quality is characterised by strict guidelines in both the HR and manufacturing areas.
- We work closely with both office and field staff, thus guaranteeing effective communication. And you benefit from our quality.





# Reliability

Agreements are binding and we stick to them.



*We are an efficient, reliable partner.  
Put us to the test...*



## 100% reliability

- Our reliability is a result of the conscientiousness and willingness of our employees.
- We keep our promises, and do so with competence and reliability.
- We guarantee good value for money.
- Expert advice and sales support is the basic principle that enables us to meet your requirements.
- We guarantee that we'll keep to the agreed dates and appointments, and this does not just apply to the delivery service for our products.
- Reliability is one of our basic principles for ensuring our availability for you.

## The reliability of our employees

The manufacture of quality products involves putting not only the quality and durability of the products to the test, but the service associated with the product also has to be just right.

Reliability is an important basis that is further strengthened by the conscientiousness and willingness of our employees. For us, agreements are binding and we stick to them. You benefit from the expertise of our competent, professional employees, as well as from our specialisation.

We want to establish a relationship of trust with you in order to further promote collaboration.

## The reliability of our processes

Our manufacturing reliability guarantees top quality. The ongoing modernisation of manufacturing processes enables us to meet your demands. Our processes are determined by structured and consistent communication, the ability to meet deadlines and by dependable delivery dates.

Your enquiries are handled individually and competently. We take your deadlines seriously.

## The reliability of our products

Whether you have questions about our products or the appropriate presentation, our office and field staff are there for you.

For us, product training and education are all par for the course. We'll advise you quickly and competently. Reliability is no coincidence.

We only work with selected suppliers in order to be able to offer you optimum product quality. We guarantee ongoing quality and functional reliability, both today and tomorrow.

Our products live up to expectations.





# Wiha product innovations.



# Wiha article series.

Series	
<b>1</b>	
129	35
148	31
148 HK5	32
148 ZK5	32
153	31
161	173
SB 161	173
162	35
162 HK6 SO	35
162 ZK6 SO	35
186	31
198-1	33
<b>2</b>	
207	173
SB 207	173
221	35
222	31
224	173
2270P	69
2270P K6	69
2271P	69
SB 24628	222
SB 24629	222
24630	211
24631	211
24632	211
24633	210
24634	210
24635	211
24636	213
24637	212
246 22 02	279
246 67	44
246 72 SB	278
246 73 SB	278
246 75 SB	278
246 76 SB	279
246 77 SB	279
246 78 SB	279
246 80 SB	279
246 36 B5	213
SB 246 01	214
SB 246 02	214
SB 246 81	44
SB 2463 001	211
255-2L	71
SB 255-2	71
255-3L	71
SB 255-3	71
255-7	71
SB 255-7	71
255-11L	71
SB 255-11	71
255-12	70
SB 255-12	71
260 VB1	40
260P	37
260P K6	40
260P K7	40
261P	37
262P	37
263P	38
263P K6	39
263P Zoll	38
264P	38

Series	
264P K6	39
264P Zoll	
265P	39
265P K6	41
265P Zoll	39
267P	37
267P K6	41
267P K6M	41
267PIP	38
267PIPR	
267PR	37
267PR K6	41
268P	39
269	119
269	119
269	119
269	119
269	120
269	120
269	120
2691	119
2691	203
269 EB53	122
269 EB95	122
269 T4	121
269 T6	121
269 T6 01	121
269 T11	121
269 T11 01	122
269 VB1	123
2691 ESD	119
2691 T11 ESD	123
270	79
270 HK3	79
271	79
272	76
272 K6	78
273	76
274	76
275	76
275 K6	78
276	76
277	76
277 K6	78
278	77
278 IP	77
278 K6	78
278 R	77
279-10	77
281 01	218
281 B11	115
281 B11 01	115
281 T6	114
281 T6 01	114
281 T11	114
281-01 ESD	218
281-02	207
281-02	218
2820 B11	117
282000	111
28201-01	227
SB 28201-01	227
28201-02	227
SB 28201-02	227
28201-03	227
SB 28201-03	227

Series	
282700	67
2831 09	55
2831 09 020	55
2831 09 021	55
2831 B601	58
2831 B602	58
2831 B603	58
2831 B701	58
2831 T16	60
2831 T701	58
2831 T701 VB	59
2831 T702	
2831 T702 VB	59
2831 T703	
2831 T703 VB	59
2831 T704	60
2831 T705	60
2831 TL	60
2831-00	
SB 2831 09 020	55
SB 2831 09 021	55
2831-10	57
2831-10	94
2831-11	57
2831-11	94
2831-12	57
2831-12	94
2831-13	57
2831-13	94
2831-14	57
2831-14	94
2831-15	57
2831-15	94
2831-17	57
2831-17	95
2831-18	57
2831-18	95
28330	102
28332	102
28339	227
28339-91	104
28339-91	113
28339-91	227
28339-92	104
28339-92	113
28339-94	113
28339-94	227
28340	102
2835	87
2836	107
28369	107
28372	105
28379	67
28379	105
284	111
284	112
284	113
SB 284	111
284949	223
284 VB1	116
284 ESD	111
284 ESD T6 01	116
2850	89
2850 S2	89
2852	88
2852 S10	88

Series	
2852 S10-01	88
2859	90
2859	91
285-900	88
285-900	93
2872	93
2872 S3	93
2872 T10	60
2872 T10	97
2872 T11	97
2872 T18	96
2872 T9	96
2879	93
2879 B7	95
2882	98
2882 S10	99
2889	99
288-900	99
2891	103
2893	103
2893 S01	103
2899	104
2899	104
2899	104
2899	104
289-900	103
292	89
<b>3</b>	
300-11	35
300-2	33
301-11	35
301-2	33
302	15
302	15
302	18
302 HK6 01	22
302 HK6 SO	22
302 ZK6 SO	22
3021	17
3021 VB	17
SB 3021 S2	17
302 ESD	73
302 ESD	73
302 ESD HK5 01	74
305	20
308	15
308 HK6	23
308 ZK6	23
311	16
311	18
3111	17
311 K6	22
311 ESD	73
311 ESD	73
312	16
313	16
313	18
313 ESD	73
3131	17
314	16
320	68
3201	51
320 K6	68
320 P7 SO	68
3201 K6	52

<b>Series</b>		<b>Series</b>		<b>Series</b>		<b>Series</b>	
3201 K6 01	52	351 PK6X	160	364	170	SB 369 R P7	159
3201 ZK6	52	SB 351 PK6X	160	364 D	165	369 R S9	134
SB 3201 S201	52	351 PK7	159	364 DS	165	SB 369 R S9	134
SB 3201 S202	52	SB 351 PK7	159	364 DS K6	165	369 R SVH1	134
SB 3201 S204	52	SB 351 PM8X	162	364 IP	170	369 R SVH2	134
320N	61	351 R8	144	364 R	170	369 R SZ13	135
320N K6	63	351 SZ13	147	364 VB	170	SB 369 R SZ13	135
320N K7	63	351 VB	144	365	172	369 R Zoll	135
320N ZK6 SO	63	351 Zoll	147	365 IP	172	369 S	131
321	68	352	141	365 IP VB	172	369 S9	137
3211	51	352 B8	142	365 VB	172	SB 369 S9	137
3211 VB	53	352 H11	141	366	155	369 S9B	140
321 N	62	352 H7	142	366 BE	153	SB 369 S9B	140
322	62	352 H7B	143	366 BE H8	153	369 SVH1	138
322 K5	63	352 H9	142	SB 366 BE H8	153	369 SVH1B	140
323 N	62	352 H9B	143	366 BE HZ13	153	369 SVH2	138
324	62	352 HM5B	143	SB 366 BE HZ13	153	369 SZ13B	146
3241	51	352 S9	141	366 BE SZ13	153	SB 369 SZ13B	146
3241 VB	53	SB 352 S9	141	SB 366 BE SZ13	153	369 T	136
325	62	352 B	142	366 H7	155	369 T S9	136
3251	51	352 N	324	366 H8	155	SB 369 T S9	136
3251 K6	53	352 N S7	324	SB 366 H8	155	369 VH1	138
327	65	353	32	366 R	149	369 Zoll	146
3271	51	355	156	366 R H8	150	370	173
SB 327 S2	65	355 T5	156	SB 366 R H8	150	370 IP	173
328	65	356	20	366 R HM7	150	370 VB	173
3281	51	357	20	SB 366 R HM7	150	371 RIP	151
SB 328 S2	65	358 1	51	366 R HZ13	149	371 RIP H8	151
331	172	358 N	62	SB 366 R HZ13	149	371 RIP HM7	151
334	168	359	145	366 R SZ13	150	372	21
334 VB	168	359 T5	145	366 SZ13	155	380... VH	224
334 Zoll	169	360	31	SB 366 SZ13	155	3801 01	224
334 D	164	361 IP	157	SB 366 R SZ13	150	SB 3801 01	224
334 DS	164	361 IP H8	157	366 SZ13 TS	154	3801 02	224
334 DS K6	165	SB 361IP H8	157	SB 366 SZ13TS	154	SB 3801 02	224
334 DSR	164	362	18	366 TS	154	3801 03	224
334 N	169	362 BE	18	367	20	SB 3801 03	224
334 R	167	362 BE K6	24	367 R	20	3801 04	224
334 R VB	167	362 ESD	74	369	137	SB 3801 04	224
336	168	362 ESD K5	74	SB 369	137	3803 01-020	226
336 N	169	362 IP	19	369 B	140	SB 3803 01-020	226
336 Zoll	169	362 K6 SO	24	369 B8	139	3803 01-021	226
338	168	362 K7	24	369 F	136	SB 3803 01-021	226
341	21	362 R	19	369 H11	139	3803 01-022	226
341 K5	25	362 R K6 SO	24	SB 369 H11	139	SB 3803 01-022	226
342	32	362 RIP	19	369 H7	139	3803 01-023	226
343	21	362 TR	19	SB 369 H7	139	SB 3803 01-023	226
344	21	362 TR K6	25	369 H7B	141	3803 01-024	226
347	21	363	156	SB 369 H7B	141	SB 3803 01-024	226
347 Zoll	21	363 H7	156	369 H9	139	3803 01-025	226
350	145	363 H8	156	SB 369 H9	139	SB 3803 01-025	226
350 H7	145	SB 363 H8	156	369 H9B	140	3803 02-020	225
350 H9	145	363 P7	160	SB 369 H9B	140	SB 3803 02-020	225
351	143	SB 363 P7	160	369 H9F	136	3803 02-021	225
351 B8	144	363 P8	160	SB 369 H9F	136	SB 3803 02-021	225
351 H11	143	363 P8 VH1	161	369 H9S	131	3803 02-022	225
351 H7	144	SB 363 P8	160	SB 369 H9S	131	SB 3803 02-022	225
351 H9	144	SB 363 PM8X	162	369 HVH1S	131	3803 02-023	225
SB 351 H9	144	363 TR	157	369 HZ8	146	SB 3803 02-023	225
351 HZ8	147	363 TR H8	157	SB 369 HZ8	146	3803 02-024	225
351 PG7	159	SB 363 TR H8	157	369 R	133	SB 3803 02-024	225
SB 351 PG7	159	363 TR P7	161	369 R H9	133	3809 01-01	222
351 PG7 VH1	161	SB 363 TR P7	161	SB 369 R H9	133	SB 3809 01-01	222
351 PG9X	160	363 TR P8	161	369 R HZ13	135	3809 01-02	222
351 PG9X VH1	161	SB 363 TR P8	161	SB 369 R HZ13	135	SB 3809 01-02	222
SB 351 PG9X	160	363 VB	156	369 R P7	159	3809 01-03	222

# Wiha article series.

Series	
SB 3809 01-03	222
3809 01-04	222
SB 3809 01-04	222
3809 284-01	223
SB 3809 284-01	223
3809 284-03	223
SB 3809 284-03	223
3809 VH01	222
384	218
386	218
387	218
387 ESD	218
388	219
388 DS	219
397	16
398	15
<b>4</b>	
400 10	44
SB 400 10	44
400 12	44
405	45
405 11	45
410 ... VH	344
410 ... VH	346
410 1000	346
410 1010	346
410 2000	346
410 2001	346
410 2005	343
410 2007	346
411 170 1	343
411 210 2	343
411 210 8	343
411 320 3	343
412 2000	348
412 2010	348
412 2020	348
412 2030	348
412 2060	348
412 2240	348
412 2260	348
412 2280	348
412 2330	348
412 2420	348
412 2440	348
412 2460	348
412 2480	348
412 2640	348
412 2650	348
412 2660	348
412 2710	348
412 2720	348
412 2740	348
412 2760	348
412 2770	348
412 2780	348
412 2810	348
412 2820	348
412 2830	348
412 2850	348
412 2920	348
412 2930	348
412 4000	349
412 4010	349
412 4030	349
412 4060	349

Series	
412 4130	349
412 4160	349
412 4220	349
412 4240	349
412 4330	349
412 4360	349
412 4420	349
412 4440	349
412 4460	349
412 4620	349
412 4640	349
412 4650	349
412 4660	349
412 4720	349
412 4730	349
412 4740	349
412 4750	349
412 4760	349
412 4770	349
412 4780	349
412 4820	349
412 4860	349
412 4920	349
412 4930	349
430 40	43
K 430 10	33
481 M01	111
SB 430 40 K10	43
SB 430 40 K1020	43
SB 430 4010	43
481 T6	117
<b>5</b>	
500	33
509	33
530	15
530 HK6	23
530 ZK6	23
531	16
532	16
540	167
540DS	164
5520	27
5521	27
5522	28
5525	28
5527	28
5528	28
5520 HK6	29
5520 ZK6	29
5527 K6	28
5533	27
5534	27
5535	28
5533 HK5	29
5533 ZK5	29
5589 N	328
5589 N K7	328
5590 N	325
5590 N T15	325
5590 N T8	325
<b>6</b>	
6874	131
<b>7</b>	
7000 EB16 ESD	123
7000 EB16 ESD	203
7000 EB26 ESD	123

Series	
7000 EB26 ESD	203
7000 Z	202
7001 Z	202
7003 Z	202
7005 Z	202
7010	248
7011	249
7012	250
7015	251
7010 D	181
7011 D	181
7010 DR	179
7011 DR	179
7011 DWS	189
7011 DWS	253
7010 HOT	184
7010 ST	193
7010 TiN	183
7010 Z	189
7010 Z L	189
7010 ZOT	185
7011 ACR	185
7011 HOT	184
7011 Inkra	187
7011 M9T	177
7011 TiN	183
7011 Z	189
7011 ZOT	185
7011 ZOT L	185
7011 ST	193
7012 ACR	185
7012 D	181
7012 DR	179
7012 HOT	184
7012 Inkra	187
7012 M9T	177
7012 ST	193
7012 TiN	183
7012 Z	189
7012 ZOT	185
7012 ZOT L	185
7013 ST	193
7013 Z	191
7013 Z TR	191
7013 R Z	191
7013 M9T	177
7015 D	181
7015 DR	179
7015 HOT	184
7015 K Z	190
7015 M9T	177
7015 ST	193
7015 TiN	183
7015 ZOT	185
7015 Z	190
7015 Z TR	190
7016 Z	190
7016 Z IPR	190
7017 Z	191
7017 R Z	191
7018 M9T	177
7018 Z	192
7019 Z SIT	192
7019 Z SP	192
7019 Z XZN	192
7019 ZOT TS	186

Series	
7019 ZOT TW	186
7020 Z	204
7021 Z	204
7022 Z	204
7023 Z	204
7025 Z	204
7044	211
7040 Z	195
7041 D	181
7041 DR	179
7041 HM	199
7041 HOT	184
7041 HS	199
7041 Inkra	187
7041 M9T	177
7041 ST	193
7041 TiN	183
7041 VB1	198
7041 VB2	198
7041 Z	195
7041 ZOT	186
7042 D	181
7042 DR	179
7042 HOT	184
7042 Inkra	187
7042 M9T	177
7042 ST	193
7042 TiN	183
7042 Z	195
7042 ZOT	186
7043 HM	199
7043 M9T	177
7043 R Z	198
7043 Z	198
7044 M	211
7044 M	253
7045 BE	196
7045 BE 9570	196
7045 HM	199
7045 HOT	184
7045 HS	199
7045 M9T	177
7045 R	196
7045 ST	193
7045 Z	197
7045 Z TR	197
7046 HM	199
7046 HS	199
7046 Z	196
7047 R Z	198
7048 M9T	177
7048 Z	197
7049 ZOT TS	186
7049 ZOT TW	186
7049 XH	195
7049 XZ	195
7050	213
7051	213
7055	213
7081 ZOT	204
7082 ZOT	204
7113	217
7110 HM	217
7110 M	202
7113 S	217
7113 S	253

Series	
7123	216
7123	253
7123 R VB1	217
7140	216
7142	216
7143	216
7143 VB1	217
7148 C	205
7148 CF	214
7148 CF	252
7148 CS	216
7148 CS	252
7148 ST	216
7149 VB06	217
7183	204
7183	217
7180-7	217
7201	212
7203	212
7204	209
7205	209
7204 K39	210
7204 M	209
7204 Z	210
7204 Z-516	213
7207 N	326
7207 N K1001	326
7208 N	327
7208 N K1001	327
7210	212
7230	212
7240	212
7240	253
7244	209
7241Z	210
7244M	209
7280	212
7311 Z	200
7312 Z	200
7321 Z	200
7322 Z	200
7325 Z	200
7331 Z	200
7332 Z	200
7341 Z	200
7342 Z	200
7802	113
7803	113
7804	206
7805	206
7806	207
7807	207
7848	207
7918 TL	206
79184 T19	206
79185 T19	206
79186 B5	207
79187 B5	207
79187 T01	319
79187 T02	319
79187 T03	319
7928-913	245
7928-923	245
7928-928	245
7929 HOT	247
7929 Inkra	247

Series	
7929 TIN	246
7929 Z	247
7929 ZOT	247
7945	231
7945	243
7945 VB1	230
7945 VB2	230
7945 VB3	230
7945 VBX1	231
7945 VBX3	231
7945-202	229
SB 7945-202	229
7945-303	229
SB 7945-303	229
7945-505	229
SB 7945-505	229
7945-903	229
SB 7945-903	229
7945-904	230
SB 7945-904	230
7945-905	230
SB 7945-905	230
7946 VB1	233
7946 VB2	233
7946 VB3	233
7946 VBX1	233
7946-202	232
SB 7946-202	232
7946-303	232
SB 7946-303	232
7946-505	232
SB 7946-505	232
7946-903	232
SB 7946-903	232
7946-904	232
SB 7946-904	232
7946-905	233
SB 7946-905	233
7947 VB1	243
7947 VB2	243
7947 VB3	243
7947 VB4	243
7947 VB5	243
7947-005	240
SB 7947-005	240
7947-045	239
SB 7947-045	239
7947-055	238
SB 7947-055	238
7947-065	238
SB 7947-065	238
7947-0D7	237
SB 7947-0D7	237
7947-0DR7	237
SB 7947-0DR7	237
7947-0I5	242
SB 7947-0I5	242
7947-0ST5	242
SB 7947-0ST5	242
7947-145	239
SB 7947-145	239
7947-245	239
SB 7947-245	239
7947-505	241
SB 7947-505	241
7947-505TR	241

Series	
SB 7947-505TR	241
7947-5ST5	242
SB 7947-5ST5	242
7947-902	241
SB 7947-902	241
7947-904	240
SB 7947-904	240
7947-905	240
SB 7947-905	240
7947-945	239
SB 7947-945	239
7947-955	238
SB 7947-955	238
7947-995	241
SB 7947-995	241
7947-999	240
SB 7947-999	240
7947-9D7	237
SB 7947-9D7	237
7947-9DR7	237
SB 7947-9DR7	237
7947-9ST4	242
SB 7947-9ST4	242
7948 VB1	236
7948 VB2	236
7948 VB3	236
7948 VB4	236
7948-005	235
7948-043	236
7948-047	235
7948-927	235
7948-928	235
7979-01	246
7979-02	246
7979-03	246
<b>8</b>	
800	338
800	338
8001	338
8001K	339
800K	339
800S	339
802	339
8021	339
829-0	336
830-0	336
831-1	335
831-3	335
831-5	335
831-8	335
831-9	335
832 B8	336
832-13	334
832-15	333
832-33	333
832-35	334
832-38	334
832-39	334
832-55	333
832-99	333
833-1	335
833-5	335
834-15	333
<b>9</b>	
9246 01	214
9300-001	318

Series	
9300-002	320
9300-007	321
9300-008	321
9300-010	322
9300-011	322
9300-012	323
9300-013	323
9300-014	324
9300-015	328
9300-016	329
9300-017	329
9300-018	320
9300-019	317
9300-020	317
9300-024	318
9300-026	319
<b>U</b>	
U 106	112
U106 T12	115
U106 T8	115
U109 00	113
U759 00	120
U759 00	203
<b>Z</b>	
Z 99 0 002 06	320
Z 99 0 003 05	316
Z 99 0 006 02	316
<b>Pliers and Tweezers</b>	
Inomic	
Z 01 0 15	261
Z 05 0 15	261
Z 12 0 15	261
Inomic VDE	
Z 01 9 16	263
Z 06 0 16	263
Z 12 9 16	263
Professional	
Z 01 0 05	265
Z 02 0 05	265
Z 05 0 05	265
Z 05 1 05	265
Z 12 0 05	266
Z 16 0 05	266
Z 18 0 05	266
Z 21 0 05	266
Z 22 0 05	266
Z 23 1 05	266
Z 55 0 05	266
Z 07 0 05	268
Z 09 0 05	268
Z 65 0 05	268
Z 65 2 05	268
Z 99 0 002 05	269
Z 99 0 005 05VH	269
Professional electric	
Z 01 0 06	271
Z 02 0 06	271
Z 05 0 06	271
Z 05 1 06	271
Z 12 0 06	272
Z 14 0 06	272
Z 16 0 06	272
Z 18 0 06	272
Z 07 0 06	273
Z 09 0 06	273
Z 14 1 06	273



# Wiha article series.

Series		Series		Series		Series	
Z 50 1 06	273	Z 44 3 01	293	ZP 20 2 14	312		
Z 55 0 06	273	Z 21 0 01	294	ZP 24 0 14	313		
Z 21 0 06	274	Z 22 0 01	294	ZP 25 2 14	313		
Z 22 0 06	274	Z 17 0 01	295	ZP 25 3 14	313		
Z 60 0 06	274	Z 23 1 01	295	ZP 46 0 14	311		
Z 99 0 001 06	275	Z 30 0 01	295	ZP 50 0 14	313		
Z 99 0 005 06VH	275	Z 31 0 01	295	ZP 99 0 140 02	313		
Z 71 1 06	276	Z 31 0 00	295				
Z 71 4 06	276	Z 33 0 01	296				
Z 71 5 06	276	Z 33 1 01	296				
Z 71 6 06	276	Z 34 0 01	296				
Z 62 0 000 06	277	Z 34 1 01	296				
Z 62 0 001 06	277	Z 33 4 01	297				
Z 62 0 002 06	277	Z 33 5 01	297				
Z 62 0 004 06	277	Z 34 4 01	298				
Z 62 0 003 06	278	Z 34 5 01	298				
246 72 SB	278	Z 99 0 007 01	299				
246 73 SB	278	Z 99 0 005 01VH	299				
246 75 SB	278	Z 26 0 00	300				
246 22 02	279	Z 26 1 00	300				
246 76 SB	279	Z 26 2 00	300				
246 77 SB	279	Z 66 0 00	300				
246 78 SB	279	Z 99 0 001 01	301				
246 80 SB	279	Z 99 0 002 01	301				
Industrial		Z 99 0 004 01	301				
Z 01 0 02	281	Z 99 0 003 01	317				
Z 02 0 02	281	Electronic					
Z 05 0 02	281	Z 40 0 03	303				
Z 05 1 02	281	Z 40 1 03	303				
Z 12 0 02	282	Z 41 1 03	303				
Z 16 0 02	282	Z 41 3 03	303				
Z 17 0 02	282	Z 41 6 03	303				
Z 18 0 02	282	Z 36 0 03	304				
Z 07 0 02	283	Z 46 0 03	304				
Z 09 0 02	283	Z 46 0 03	304				
Z 55 0 02	283	Z 49 2 03	304				
Z 21 0 02	284	Z 49 7 03	304				
Z 22 0 02	284	Professional ESD					
Z 99 0 005 02VH	284	Z 40 1 04	306				
Industrial electric		Z 40 3 04	306				
Z 01 0 09	286	Z 40 4 04	306				
Z 05 0 09	286	Z 41 1 04	306				
Z 05 1 09	286	Z 41 3 04	306				
Z 02 0 09	286	Z 41 4 04	306				
Z 50 1 09	287	Z 43 1 04	307				
Z 12 0 09	287	Z 44 1 04	307				
Z 16 0 09	287	Z 44 3 04	307				
Z 55 0 09	288	Z 46 1 04	307				
Z 99 0 001 09	288	Z 46 4 04	307				
Z 99 0 005 09VH	288	Z 36 0 04	308				
Classic		Z 36 1 04	308				
Z 01 0 01	290	Z 47 1 04	308				
Z 02 0 01	290	Z 47 2 04	308				
Z 05 0 01	290	Z 37 0 04	309				
Z 05 1 01	290	Z 38 0 04	309				
Z 12 0 01	291	Z 99 0 001 04	309				
Z 16 0 01	291	Tweezers					
Z 18 0 01	291	ZP 01 0 14	311				
Z 50 1 01	291	ZP 06 0 14	311				
Z 14 1 01	292	ZP 07 1 14	311				
Z 36 0 01	292	ZP 09 0 14	311				
Z 55 0 01	292	ZP 11 0 14	312				
Z 60 0 01	292	ZP 15 0 14	312				
Z 07 0 01	293	ZP 16 0 14	312				
Z 09 0 01	293	ZP 18 0 14	312				
Z 15 0 01	293	ZP 20 1 14	312				

# Wiha list of order numbers.

Order-No.		Order-No.		Order-No.		Order-No.	
<b>000...</b>		<b>003...</b>		<b>005...</b>		<b>006...</b>	
00057	35	00328	33	00533	38	00600	120
00058	35	00373	173	00534	38	00601	119
00059	35	00374	173	00535	38	00602	119
00060	35	00375	173	00536	39	00603	119
00097	31	00376	173	00537	38	00610	121
00098	31	00377	173	00538	38	00613	121
00099	31	00378	173	00539	38	00616	121
<b>001...</b>		00379	173	00540	38	00620	123
00100	31	<b>004...</b>		00541	38	00623	115
00101	31	00412	35	00542	38	00629	112
00102	31	00413	35	00543	38	00630	112
00103	31	00414	35	00544	39	00631	112
00105	32	00416	31	00545	39	00632	112
00108	32	00418	31	00546	39	00635	112
00109	31	00422	31	00547	39	00636	112
00111	31	00423	31	00548	39	00637	112
00112	31	00426	31	00549	39	00638	112
00115	31	00432	173	00550	39	00639	112
00116	31	00432	173	00551	39	00639	112
00117	31	00433	173	00552	39	00654	112
00119	31	00434	173	00553	39	00655	112
00120	31	00456	71	00554	39	00656	112
00144	173	00475	37	00555	39	00657	112
00145	173	00476	37	00556	39	00658	112
00146	173	00477	37	00557	41	00665	112
00147	35	00478	37	00558	39	00666	112
00151	35	00479	37	00559	39	00667	112
00152	35	00480	37	00560	39	00679	33
00153	35	00481	37	00561	39	00683	33
00154	35	00482	37	00562	39	00684	15
00156	35	00484	37	00563	39	00685	15
00157	35	00485	37	00564	39	00686	15
00158	35	00486	37	00565	39	00687	15
00159	35	00487	37	00566	37	00689	15
<b>002...</b>		00488	37	00567	37	00690	15
00201	31	00490	37	00568	37	00691	15
00202	31	00492	37	00569	37	00692	15
00203	31	00493	37	00570	37	00694	15
00204	31	00495	37	00571	37	00695	15
00206	31	00497	37	00572	37	00696	15
00207	31	00498	37	00573	37	00697	15
00208	31	00499	37	00574	39	00698	15
00209	31	<b>005...</b>		00576	119	<b>007...</b>	
00210	31	00503	40	00577	119	00700	15
00211	31	00504	40	00578	119	00701	15
00212	31	00511	37	00579	119	00702	15
00213	31	00512	37	00580	119	00703	15
00214	31	00513	37	00582	120	00704	15
00215	31	00514	37	00583	120	00706	15
00218	31	00515	37	00584	120	00707	15
00219	31	00516	37	00585	120	00708	15
00220	31	00517	37	00586	120	00709	15
00221	31	00518	37	00587	120	00711	15
00222	31	00519	38	00588	120	00712	15
00223	31	00520	38	00589	120	00713	15
00226	31	00521	38	00590	120	00731	15
00227	31	00522	38	00591	120	00732	15
00229	31	00523	38	00592	120	00733	15
00230	31	00524	38	00593	120	00734	15
00231	31	00525	38	00594	120	00735	15
00234	31	00526	38	00595	120	00736	15
00235	31	00527	38	00596	120	00737	15
00236	31	00528	38	00597	120	00738	15
00237	31	00530	38	00598	120	00739	15
		00531	38	00599	120	00740	15
		00532	38			00754	16

# Wiha list of order numbers.



Order-No.		Order-No.		Order-No.		Order-No.	
00756	16	00858	62	00982	168	01131	145
00757	16	00859	62	00983	168	01132	145
00759	16	00860	62	00985	168	01133	145
00760	16	00861	62	00986	168	01134	145
00762	16	00862	62	00988	168	01135	145
00763	16	00863	62	00989	168	01136	145
00764	16	00864	62	00990	168	01137	145
00765	16	00865	62	00991	168	01138	145
00766	16	00866	62	00993	168	01139	145
00767	16	00867	62	00994	168	01140	145
00768	16	00868	62	00995	168	01141	145
00770	16	00877	62	<b>010...</b>		01142	145
00772	16	00878	62	01005	168	01143	145
00774	16	00879	62	01006	168	01144	143
00776	16	00880	62	01007	168	01145	143
00777	16	00881	62	01008	168	01146	143
00778	16	00882	62	01018	21	01147	143
00779	16	00894	172	01020	21	01148	143
00782	68	00895	172	01021	21	01149	143
00783	68	00896	172	01022	21	01150	143
00784	68	00897	172	01023	21	01151	143
00785	68	<b>009...</b>		01024	21	01152	143
00786	68	00904	168	01025	21	01153	143
00787	68	00905	168	01026	21	01154	143
00788	68	00906	168	01027	21	01155	143
00789	68	00907	168	01028	21	01156	143
00790	68	00908	168	01029	21	01157	143
00791	68	00909	168	01030	21	01158	143
00792	68	00910	168	01031	21	01159	143
00793	68	00911	168	01032	21	01160	143
00794	68	00912	168	01033	21	01161	143
00795	68	00913	168	01034	25	01162	143
00796	68	00914	168	01051	32	01166	144
00797	68	00915	168	01053	32	01172	144
<b>008...</b>		00916	168	01054	32	01174	144
00815	68	00917	168	01055	32	01176	147
00819	61	00918	168	01056	32	01180	144
00820	61	00919	168	01057	32	01182	144
00821	61	00921	168	01058	32	01184	147
00822	61	00922	168	01059	32	01185	147
00823	61	00923	168	01060	32	01186	147
00824	61	00924	168	01061	32	01187	147
00825	61	00926	168	01062	32	01188	147
00826	61	00928	168	01063	32	01189	147
00827	61	00929	168	01064	32	01190	147
00828	61	00930	168	01065	32	01191	147
00829	61	00931	168	01076	21	01192	147
00830	61	00933	168	01077	21	01193	147
00831	61	00934	168	01078	21	01194	147
00832	61	00937	168	01079	21	01195	147
00833	63	00953	168	01081	21	01197	147
00834	63	00965	168	01092	21	01198	147
00836	68	00966	168	01093	21	<b>012...</b>	
00837	68	00967	168	01094	21	01200	147
00838	68	00968	168	01095	21	01201	141
00839	68	00969	168	01096	21	01202	141
00840	68	00970	168	01097	21	01203	141
00846	62	00971	168	01098	21	01204	141
00847	62	00972	168	<b>011...</b>		01206	141
00848	62	00973	168	01121	145	01207	141
00849	62	00974	168	01122	145	01208	141
00850	62	00975	168	01123	145	01209	141
00853	62	00977	168	01124	145	01210	141
00855	62	00978	168	01126	145	01211	141
00856	62	00979	168	01128	145	01212	141
00857	62	00980	168	01130	145	01213	141

<b>Order-No.</b>		<b>Order-No.</b>		<b>Order-No.</b>		<b>Order-No.</b>	
01214	141	01320	156	01475	218	01734	191
01215	141	01321	156	01476	218	01735	191
01216	142	01322	156	01479	218	01736	191
01220	142	01323	156	01481	219	01737	191
01222	142	01324	156	<b>015...</b>		01738	191
01224	32	01326	156	01508	44	01739	191
01225	32	01328	170	01531	33	01740	191
01226	32	01329	170	01532	33	01741	204
01227	32	01330	170	01537	33	01742	204
01228	32	01331	170	01538	33	01744	204
01229	32	01332	170	01539	33	01745	204
01243	156	01333	170	01548	33	01746	204
01244	156	01334	170	<b>016...</b>		01747	204
01245	156	01335	170	01604	189	01748	204
01246	156	01336	170	01606	189	01749	204
01247	156	01337	170	01607	189	01750	204
01248	156	01338	170	01609	189	01751	204
01249	156	01339	170	01610	189	01753	204
01255	145	01340	170	01612	189	01754	204
01256	145	01341	170	01613	189	01755	204
01257	145	01343	170	01617	189	01756	204
01258	145	01345	170	01619	189	01758	204
01259	145	01348	170	01621	189	01759	204
01260	145	01350	172	01623	189	01760	204
01261	145	01351	172	01624	189	01761	204
01262	145	01352	172	01626	189	01762	204
01263	145	01353	172	01627	189	01763	204
01264	31	01354	172	01649	189	01764	204
01266	31	01355	172	01657	189	01765	204
01267	31	01356	172	01658	189	01766	204
01268	31	01391	140	01659	189	01767	204
01269	31	01392	137	01681	189	01768	204
01270	31	01393	137	01688	189	01769	204
01271	31	01395	137	01689	189	01770	204
01285	18	01396	137	01690	189	01771	204
01286	18	01398	137	<b>017...</b>		01790	195
01287	18	<b>014...</b>		01703	191	01791	195
01288	18	01400	137	01704	191	01792	195
01289	18	01402	137	01705	191	01793	195
01290	18	01404	137	01706	191	01794	195
01291	18	01406	137	01707	191	01795	195
01292	18	01408	137	01708	191	01796	195
01293	18	01410	139	01709	191	01798	195
01294	18	01416	139	01710	191	01799	195
01295	18	01418	139	01711	190	<b>018...</b>	
01296	18	01420	146	01712	190	01800	195
01297	18	01422	146	01713	190	01803	195
01299	24	01423	146	01714	190	01805	195
<b>013...</b>		01424	146	01715	190	01808	195
01300	19	01425	146	01716	190	01809	195
01301	19	01426	146	01717	190	01811	195
01302	19	01427	146	01718	190	01812	195
01303	19	01428	146	01719	190	01894	217
01304	19	01429	146	01720	190	01894	217
01305	19	01430	146	01721	190	01895	217
01306	19	01431	146	01722	190	<b>019...</b>	
01310	156	01432	146	01723	190	01910	216
01311	156	01433	146	01724	190	01912	216
01312	156	01434	146	01726	190	01913	216
01313	156	01435	21	01727	190	01919	204
01314	156	01436	21	01728	190	01919	217
01315	156	01437	21	01729	190	01922	212
01316	156	01438	21	01730	190	01923	212
01317	156	01439	21	01731	190	01924	212
01318	156	01440	21	01732	190	01926	212
01319	156	01443	21	01733	190	01927	212

# Wiha list of order numbers.

Order-No.		Order-No.		Order-No.		Order-No.	
01930	212	02811	169	03873	140	04553	204
01933	212	02819	169	03874	140	04631	211
01934	212	02820	169	03875	140	04632	211
01935	212	02821	169	03876	140	04633	211
01936	212	02822	169	03878	141	04634	211
01937	200	02823	169	03879	140	04635	211
01938	200	02824	169	03882	113	04636	211
01939	200	02836	21	03883	113	04637	211
01940	200	02837	21	03988	45	04638	211
01942	200	02838	21	03991	141	04639	211
01943	200	02839	21	03992	140	04640	211
01945	200	02840	21			04654	183
01946	200	02841	21			04655	183
01947	200	02939	146			04656	183
01948	200					04657	183
	<b>02...</b>		<b>03...</b>		<b>04...</b>	04658	183
02091	338	03106	19	04009	195	04659	183
02092	338	03107	19	04010	195	04670	200
02093	338	03108	19	04011	191	04671	200
02094	338	03115	190	04059	195	04677	200
02095	338	03117	190	04096	167	04678	200
02096	338	03186	119	04099	167	04684	212
02097	338	03223	15	04105	167	04685	212
02098	338	03224	15	04108	167	04689	185
02099	338	03225	15	04111	167	04691	185
02101	338	03226	15	04126	195	04693	185
02102	339	03228	15	04127	195	04695	185
02103	339	03230	15	04176	195	04697	185
02104	339	03231	15	04194	198	04699	185
02105	339	03232	15	04195	198	04711	202
02106	339	03237	16	04196	198	04712	202
02107	339	03238	16	04197	198	04713	202
02108	339	03239	16	04198	198	04714	202
02109	339	03245	16	04204	212	04715	202
02110	339	03246	16	04362	212	04716	202
02111	339	03247	16	04451	173	04717	202
02113	339	03591	114	04454	173	04718	202
02114	339	03723	139	04455	173	04719	202
02115	339	03724	173	04461	37	04720	202
02116	339	03725	173	04462	37	04721	202
02117	339	03726	173	04481	184	04722	202
02122	339	03727	173	04482	184	04723	202
02123	339	03728	173	04483	184	04724	202
02124	339	03729	173	04484	184	04725	202
02125	339	03727	173	04485	184	04726	202
02126	339	03728	173	04486	184	04727	202
02127	339	03729	173	04508	211	04728	202
02128	339	03730	173	04509	211	04729	202
02129	339	03731	173	04510	211	04730	202
02163	79	03734	144	04511	211	04731	202
02164	79	03738	16	04512	211	04732	202
02167	79	03739	16	04513	211	04733	202
02168	79	03760	62	04514	211	04734	202
02169	79	03761	62	04515	211	04735	202
02171	79	03762	62	04516	211	04736	202
02292	139	03764	156	04517	211	04737	202
02568	44	03765	41	04539	186	04743	183
02802	169	03847	45	04540	186	04744	183
02803	169	03848	45	04541	186	04745	183
02804	169	03849	45	04542	184	04746	183
02805	169	03850	45	04543	184	04861	183
02806	169	03851	45	04544	184	04862	183
02807	169	03852	45	04545	186	04863	183
02808	169	03853	45	04546	186	04864	183
02809	169	03854	45	04547	186	04865	183
02810	169	03868	140	04548	184	04866	183
		03869	140	04549	184		
		03870	140	04550	184		
		03871	140	04551	204		
		03872	140	04552	204		



<b>Order-No.</b>			<b>Order-No.</b>			<b>Order-No.</b>			<b>Order-No.</b>		
04918		172	06570		68	07850		250	08169		137
04919		185	06571		68	07851		250	08170		137
04920		185	06573		68	07855		249	08179		73
04921		185	06634		192	07856		249	08182		73
04922		185	06635		192	07857		249	08183		73
04923		185	06636		192	07858		249	08184		73
04924		185	06637		197	07859		250	08185		73
04925		190	06638		197	07860		250	08186		73
04926		190	06639		197	07861		250	08419		248
04927		190	06888		195	07862		250	08420		248
04928		190	06889		195	07863		248	08421		251
04929		190		<b>07...</b>		07864		248	08422		251
04930		190	07149		35	07865		252	08423		251
04931		190	07150		35	07866		252	08424		251
04960		204	07151		68	07869		253	08425		251
04961		204	07152		22	07870		251	08426		251
04962		204	07153		22	07871		251	08427		253
	<b>05...</b>		07155		24	07872		251	08453		248
05069		185	07181		141	07873		251	08454		248
05074		185	07185		137	07874		251	08455		248
05075		185	07186		140	07875		251	08461		187
05076		185	07190		141	07876		249	08463		78
05077		185	07192		137	07877		249	08900		112
05270		71	07193		140	07878		249	08901		112
05271		71	07194		138	07879		249	08902		112
05280		31	07195		140	07880		250	08903		112
05288		185	07634		76	07881		250	08904		112
05289		185	07635		76	07882		250	08905		112
05290		185	07636		76	07883		250	08906		112
05292		185	07637		76	07887		249	08907		112
05293		185	07638		76	07888		250	08908		112
05295		184	07639		76	07922		137	08909		112
05296		184	07640		76	07943		245	08911		112
05298		189	07641		76		<b>08...</b>		08921		113
05299		185	07642		76	08047		247		<b>09...</b>	
05300		189	07643		76	08048		247	09195		120
05301		198	07644		76	08049		247	09195		203
05302		198	07645		76	08050		247	09393		245
05303		198	07646		76	08051		247	09400		214
05638		140	07647		76	08052		247	09495		248
05799		195	07648		76	08053		246	09496		248
05800		195	07649		76	08054		246		<b>20...</b>	
	<b>06...</b>		07650		76	08055		246	20122		37
06059		142	07651		76	08056		247	20123		37
06218		145	07652		76	08057		247	20150		189
06358		142	07653		76	08058		247	20150		253
06359		142	07654		76	08059		247	20218		197
06360		142	07655		76	08060		247	20219		197
06361		142	07656		76	08061		247	20220		197
06362		142	07657		76	08062		246	20221		197
06363		142	07658		76	08063		246	20222		197
06364		142	07659		77	08064		246	20223		197
06365		142	07660		77	08065		247	20224		197
06366		142	07661		77	08066		247	20542		250
06367		142	07662		77	08067		247	20549		133
06368		142	07663		77	08068		247	20550		133
06369		142	07664		77	08069		247	20551		133
06370		142	07665		77	08070		247	20552		133
06371		142	07666		77	08161		137	20553		133
06378		145	07667		77	08162		137	20554		214
06379		145	07821		249	08163		137	20555		191
06382		143	07828		249	08164		137	20556		191
06384		143	07846		249	08165		137	20557		191
06386		143	07847		249	08166		137	20558		191
06568		68	07848		250	08167		137	20559		191
06569		68	07849		250	08168		137	20560		191

# Wiha list of order numbers.

Order-No.		Order-No.		Order-No.		Order-No.	
20570	133	<b>22...</b>		22960	191	23378	181
20709	134	22096	167	22961	191	23380	181
20712	134	22107	249	22962	191	23382	181
20783	214	22109	249	<b>23...</b>		23384	181
20814	249	22111	249	23031	159	23386	181
20818	249	22113	249	23033	159	23388	179
20820	250	22115	250	23035	159	23390	179
20822	250	22117	250	23037	159	23392	179
20824	250	22119	250	23040	159	23394	179
20827	250	22121	250	23041	159	23396	179
20834	187	22123	251	23047	160	23398	179
20842	202	22125	251	23049	160	23502	161
20843	202	22127	251	23051	160	23503	161
20940	185	22129	251	23053	160	<b>24...</b>	
20942	185	22131	251	23104	179	24002	41
20945	185	22133	251	23106	179	24105	157
20946	185	22168	167	23110	179	24107	157
20948	185	22170	167	23114	179	24109	157
20950	185	22172	167	23116	179	24111	157
20952	185	22174	167	23118	179	24113	157
20954	185	22318	249	23120	179	24115	157
20956	185	22320	249	23122	179	24117	157
20958	185	22322	249	23124	179	24119	157
20960	185	22324	250	23133	179	24121	157
20964	183	22326	250	23135	179	24123	157
20966	183	22328	250	23137	179	24189	146
20968	183	22406	147	23139	179	24190	135
20970	183	22436	74	23141	179	24267	249
20972	183	22509	195	23143	179	24269	249
20974	183	22510	195	23145	198	24271	250
20976	183	22511	195	23147	198	24273	250
20978	183	22512	195	23149	198	24302	135
20980	183	22591	186	23151	198	24303	135
20982	183	22592	186	23159	43	24304	135
20984	183	22593	186	23173	190	24305	135
<b>21...</b>		22594	186	23175	190	24306	135
21045	197	22595	186	23177	190	24307	135
21047	197	22596	186	23179	190	24308	135
21193	181	22597	186	23181	190	24312	155
21194	181	22598	186	23183	190	24313	155
21196	181	22599	186	23185	190	24314	155
21198	181	22600	186	23187	190	24315	155
21200	181	22603	186	23189	190	24316	155
21202	181	22604	186	23191	190	24317	155
21204	181	22605	186	23193	190	24318	155
21206	181	22606	186	23195	196	24319	155
21208	181	22607	186	23197	196	24320	155
21210	181	22608	186	23199	196	24321	155
21212	181	22609	186	23201	196	24322	155
21214	181	22610	186	23203	196	24323	155
21216	181	22611	186	23205	196	24324	155
21220	181	22612	186	23207	196	24325	155
21228	187	22640	251	23209	196	24341	135
21229	187	22641	251	23211	196	24492	44
21231	187	22643	251	23213	195	24506	25
21233	187	22645	251	23215	195	24513	157
21248	23	22647	250	23217	195	24515	157
21249	23	22649	249	23219	195	24517	157
21250	23	22651	252	23221	195	24519	157
21251	23	22653	252	23223	195	24521	157
21255	77	22655	252	23225	195	24523	157
21256	77	22955	191	23226	195	24525	157
21272	181	22956	191	23227	195	24527	157
21960	167	22957	191	23228	195	24529	157
21962	167	22958	191	23265	134	24531	157
		22959	191	23376	181	24533	157

Order-No.		Order-No.		Order-No.		Order-No.	
24713	248	26061	90	26173	165	26329	20
24727	249	26062	90	26174	165	26330	20
24733	249	26063	90	26175	165	26331	20
24738	250	26064	91	26176	165	26332	20
24742	250	26065	91	26177	165	26333	20
24746	251	26066	91	26178	165	26346	190
24748	251	26067	91	26179	219	26347	190
24750	251	26068	91	26181	172	26348	190
24752	249	26069	91	26182	172	26349	190
24754	249	26070	91	26183	172	26350	190
24756	250	26071	91	26184	172	26351	190
24758	250	26072	91	26185	172	26352	192
24850	135	26073	91	26186	172	26353	192
24851	146	26077	20	26187	172	26354	192
24852	155	26079	20	26188	172	26355	192
24859	160	26081	20	26190	20	26356	192
24861	160	26083	20	26191	20	26417	336
24867	197	26085	20	26192	20	26418	336
<b>25...</b>		26087	20	26193	20	26419	336
25097	190	26091	19	26194	20	26420	336
25128	161	26093	19	26195	20	26421	336
25130	161	26095	19	26196	90	26422	335
25164	161	26097	19	26197	90	26423	335
25166	161	26099	19	26198	90	26424	335
25293	160	26101	19	26199	90	26425	335
25295	160	26103	19	26200	90	26426	335
25297	161	26105	19	26212	21	26427	335
25477	63	26107	19	26213	21	26428	335
25553	196	26109	19	26214	21	26429	335
25560	191	26111	19	26216	21	26430	335
25561	191	26113	22	26217	21	26431	333
25562	191	26121	121	26218	21	26432	333
25563	191	26122	120	26221	90	26433	333
25564	191	26123	120	26222	90	26434	334
25572	186	26124	120	26223	90	26435	334
25610	147	26127	89	26224	90	26436	334
25624	172	26128	89	26225	90	26437	334
25625	173	26129	89	26227	90	26438	335
25626	147	26130	89	26228	90	26439	333
25673	37	26131	89	26229	91	26451	251
25674	37	26133	89	26230	20	26454	16
25676	77	26135	164	26231	20	26455	16
25677	77	26136	164	26232	20	26456	19
25679	252	26137	164	26233	20	26457	19
25681	252	26138	164	26234	20	26458	19
25739	198	26139	164	26235	20	26461	88
25740	198	26140	164	26247	165	26462	88
25741	198	26146	22	26248	165	26463	88
25742	198	26148	90	26249	186	26464	88
25874	218	26151	90	26250	190	26509	333
25994	190	26152	91	26252	246	26510	335
25996	190	26154	91	26253	246	26511	335
25998	190	26155	91	26255	217	26512	335
<b>26...</b>		26156	91	26259	18	26513	335
26000	196	26157	91	26260	18	26514	335
26002	196	26158	91	26261	172	26544	90
26045	186	26159	91	26277	90	26582	334
26047	89	26164	164	26278	90	26611	334
26048	89	26165	164	26279	90	26612	334
26049	89	26166	164	26303	20	26613	334
26051	89	26167	164	26304	20	26614	334
26052	89	26168	164	26305	20	26615	335
26053	89	26169	164	26307	20	26616	335
26058	90	26170	164	26309	191	26618	335
26059	91	26171	164	26327	89	26620	335
26060	90	26172	165	26328	20	26625	93

# Wiha list of order numbers.

Order-No.		Order-No.		Order-No.		Order-No.	
26626	93	26731	268	26806	309	26959	170
26627	93	26732	273	26808	306	26960	170
26629	98	26733	293	26812	303	26964	18
26640	333	26734	268	26813	303	26965	18
26641	333	26735	273	26814	306	26966	18
26642	333	26736	266	26815	303	26967	18
26643	333	26737	272	26816	306	26968	18
26644	333	26738	291	26818	303	26969	18
26645	333	26739	291	26821	306	26970	18
26646	333	26740	266	26822	306	26971	18
26647	333	26741	272	26825	303	26972	18
26648	333	26742	291	26826	307	26973	18
26649	334	26743	266	26830	304		
26650	334	26744	272	26831	307	<b>27...</b>	
26651	334	26745	272	26832	307	27028	186
26652	334	26746	291	26833	304	27030	186
26653	333	26747	266	26835	307	27055	346
26654	333	26748	272	26838	307	27057	346
26655	333	26749	291	26839	308	27058	346
26656	333	26750	266	26840	308	27059	346
26657	334	26751	272	26845	292	27060	346
26658	334	26752	291	26846	266	27061	346
26659	334	26753	266	26847	273	27062	346
26660	334	26754	272	26847	273	27063	346
26661	334	26755	320	26850	301	27064	192
26662	333	26757	295	26852	275	27065	192
26663	335	26758	295	26853	301	27066	192
26664	335	26758	295	26854	269	27067	192
26665	335	26759	295	26855	317	27079	90
26666	335	26760	294	26856	316	27082	343
26667	336	26761	294	26864	88	27083	343
26668	336	26762	267	26864	93	27084	348
26669	336	26763	294	26865	98	27085	348
26670	336	26764	294	26866	98	27087	348
26671	336	26765	294	26868	99	27089	348
26672	336	26766	267	26869	99	27093	348
26673	335	26767	294	26870	99	27094	348
26674	333	26771	295	26871	99	27095	348
26703	290	26772	295	26872	99	27098	348
26704	265	26773	295	26873	99	27099	348
26705	271	26774	295	26875	99	27100	348
26706	290	26775	295	26876	99	27101	348
26707	265	26776	295	26877	99	27102	348
26708	271	26777	295	26878	99	27103	348
26709	290	26778	295	26878	99	27104	348
26710	265	26779	295	26879	99	27105	348
26711	271	26780	295	26880	99	27106	348
26712	290	26781	296	26881	99	27107	348
26713	265	26782	296	26882	99	27108	348
26714	271	26783	296	26883	99	27109	348
26715	290	26784	296	26884	99	27110	349
26716	265	26785	296	26885	99	27111	349
26717	271	26785	296	26888	88	27112	349
26718	290	26786	296	26889	90	27113	349
26719	265	26787	296	26893	88	27114	349
26720	271	26788	296	26901	89	27115	349
26721	290	26789	296	26919	78	27116	349
26722	265	26790	296	26920	43	27117	349
26723	290	26791	296	26925	89	27118	349
26724	265	26792	296	26928	73	27119	349
26725	290	26794	296	26929	73	27120	349
26726	265	26795	296	26931	15	27121	349
26727	271	26796	296	26953	170	27122	349
26728	271	26797	296	26954	170	27123	349
26729	271	26799	308	26955	170	27124	349
26730	293	26801	304	26956	170	27125	349
		26802	308	26957	170	27126	349
		26804	309	26958	170		

Order-No.		Order-No.		Order-No.		Order-No.	
27127	349	27373	295	27450	307	27752	77
27128	349	27374	295	27451	307	27753	15
27129	349	27375	295	27452	308	27754	15
27130	349	27376	295	27453	308	27755	15
27131	349	27377	295	27501	295	27756	16
27132	349	27378	295	27502	295	27757	16
27133	349	27379	295	27503	295	27758	16
27134	349	27380	295	27504	295	27759	77
27135	349	27381	294	27507	266	27761	77
27144	74	27382	294	27526	91	27762	77
27145	74	27383	294	27530	190	27763	77
27146	74	27384	294	27606	43	27764	77
27147	74	27388	303	27614	173	27765	77
27148	74	27390	303	27615	173	27766	77
27149	74	27391	303	27616	173	27767	77
27150	73	27393	303	27617	173	27811	19
27151	73	27395	303	27618	173	27812	91
27252	74	27397	304	27619	173	27813	91
27253	74	27398	304	27620	173	27814	91
27256	192	27399	265	27621	173	27815	91
27257	192	27400	265	27625	111	27816	91
27258	192	27401	265	27627	112	27817	91
27259	192	27402	265	27628	112	27818	91
27260	192	27403	265	27629	112	27820	122
27279	99	27404	265	27630	113	27873	206
27325	290	27405	265	27631	113	27876	206
27326	304	27406	265	27632	113	27877	206
27327	265	27407	268	27633	113	27879	206
27328	271	27408	268	27634	113	27880	206
27329	308	27409	266	27635	113	27881	206
27336	290	27410	266	27636	113	27882	206
27337	290	27411	266	27637	113	27883	206
27338	290	27412	266	27638	113	27884	206
27339	290	27413	266	27639	113	27885	206
27340	290	27414	267	27641	74	27886	206
27341	290	27415	267	27687	99	27887	206
27342	290	27417	266	27707	76	27888	206
27343	290	27418	271	27708	76	27889	206
27344	293	27419	271	27711	99	27890	206
27345	293	27420	271	27712	115	27891	206
27346	291	27421	271	27713	115	27892	207
27347	291	27422	271	27714	115	27893	207
27348	291	27423	271	27715	114	27894	207
27349	291	27424	271	27717	117	27895	207
27350	294	27425	271	27729	37	27896	207
27351	294	27426	273	27730	37	27897	207
27352	296	27427	273	27731	37	27898	207
27353	296	27428	272	27732	37	27899	207
27354	296	27429	272	27733	37	27900	207
27355	296	27430	272	27734	37	27901	207
27356	296	27431	272	27736	19	27902	43
27357	296	27432	272	27737	19	27905	308
27358	296	27434	272	27738	19	27907	276
27359	296	27435	272	27739	19	27910	276
27360	296	27437	273	27740	19	27928	169
27361	296	27439	308	27741	19	27929	169
27362	296	27440	309	27742	19	27930	169
27363	296	27441	309	27743	19	27931	169
27364	296	27442	306	27744	19	27932	169
27365	296	27443	306	27745	19	27933	169
27366	296	27444	306	27746	24	27934	169
27367	296	27445	306	27747	41	27935	169
27368	292	27446	306	27748	77	27936	162
27370	291	27447	307	27749	77	27939	162
27371	291	27448	307	27750	77	27963	207
27372	295	27449	307	27751	77	27964	170



# Wiha list of order numbers.

Order-No.	
27965	170
27966	170
27967	170
27968	170
27969	170
27970	170
27971	170
<b>28...</b>	
28005	19
28006	348
28024	206
28025	206
28026	207
28027	207
28028	206
28050	336
28051	339
28052	339
28053	76
28055	206
28056	206
28057	206
28058	207
28142	318
28143	320
28198	77
28330	292
28372	164
28373	164
28374	164
28375	164
28376	164
28377	164
28402	268
28481	196
28691	103
28734	104
28735	104
28736	104
28737	104
28738	104
28739	104
28740	104
28741	104
28742	104
28743	104
28744	104
28745	104
28746	104
28747	104
28748	104
28749	104
28756	104
28757	104
28758	104
28760	19
28761	19
28762	19
28763	19
28764	19
28765	19
28766	19
28767	19
28768	19
28769	19
28770	19

Order-No.	
<b>29...</b>	
29100	38
29101	38
29102	38
29103	38
29104	38
29105	38
29106	38
29107	38
29108	38
29115	27
29116	27
29117	27
29118	27
29119	27
29120	27
29121	27
29122	27
29123	27
29124	29
29125	29
29133	27
29134	27
29135	27
29136	27
29137	27
29138	29
29139	29
29140	27
29141	27
29142	27
29143	27
29144	27
29145	27
29149	27
29150	27
29151	27
29152	28
29153	28
29154	28
29158	28
29159	28
29160	28
29161	28
29162	28
29163	28
29164	28
29165	28
29166	28
29167	28
29168	28
29169	28
29170	28
29171	28
29172	28
29173	28
29174	28
29175	28
29176	28
29177	28
29197	151
29198	151
29199	151
29200	151
29201	151
29202	151

Order-No.	
29203	151
29204	151
29205	151
29206	151
29207	151
29208	151
29228	103
29229	103
29230	103
29231	103
29232	103
29233	103
29234	103
29236	103
29415	235
29416	235
29417	235
29420	276
29422	343
29425	296
29427	296
29428	296
29429	296
29435	300
29436	300
29437	300
29438	300
29439	300
29440	300
29441	300
29442	300
29443	300
29446	348
29447	349
29463	218
29466	63
29467	91
29471	135
29472	135
29473	135
29474	135
29475	135
29485	300
29486	300
29487	300
29541	236
29544	247
29550	268
29553	91
29554	91
29555	91
29556	91
29557	91
29558	91
29559	91
29560	91
29875	247
29876	247
29877	247
29878	247
29879	247
29880	247
<b>30...</b>	
30050	191
30066	292
30361	62

Order-No.	
30362	62
30363	62
30364	62
30365	62
30366	62
30372	111
30373	119
30373	203
30404	111
30495	98
30518	348
30519	349
30658	263
30666	263
30700	65
30701	65
30715	65
30716	65
30824	316
30826	281
30827	282
30852	91
30975	282
30976	282
30978	281
30979	281
<b>31...</b>	
31233	149
31234	149
31235	149
31236	149
31237	149
31238	149
31239	149
31240	149
31241	149
31242	149
31243	149
31244	149
31432	74
31439	343
31492	150
31496	111
31497	116
31498	119
31499	123
31771	71
31815	184
31816	184
31817	184
31818	184
31819	184
31820	184
31863	61
31901	74
31913	251
31923	150
31928	199
31929	199
31930	199
31931	199
31932	199
31933	199
31934	199
31936	199
31938	199

Order-No.		Order-No.		Order-No.		Order-No.	
31939	199	32254	18	32357	20	32513	209
31940	199	32255	18	32358	20	32514	209
31941	199	32256	18	32359	20	32515	209
31942	199	32264	20	32360	20	32516	209
31943	199	32265	20	32361	20	32517	209
31944	199	32278	78	32362	20	32518	209
31945	199	32279	78	32363	20	32519	209
31947	199	32281	65	32364	20	32520	209
31948	199	32282	65	32383	15	32521	209
31949	199	32292	207	32384	15	32522	209
31950	199	32293	207	32386	153	32523	209
31951	199	32294	207	32387	153	32524	209
31952	199	32295	207	32388	153	32525	209
31953	199	32296	207	32389	153	32526	209
31954	199	32297	207	32390	153	32527	209
31957	195	32298	114	32391	153	32528	209
31958	195	32299	197	32392	153	32529	209
31959	195	32302	197	32393	153	32530	209
31960	195	32303	197	32394	153	32531	209
31961	195	32304	197	32395	153	32532	209
31962	195	32305	197	32396	62	32533	209
31964	199	32306	197	32397	62	32534	209
31965	199	32307	197	32399	15	32535	209
31966	199	32308	197	32400	15	32536	209
31973	196	32309	197	32404	16	32537	209
31975	196	32310	219	32405	16	32538	209
31977	196	32311	219	32406	16	32539	209
31984	199	32312	76	32409	196	32540	209
31986	199	32313	76	32410	196	32541	209
31990	247	32314	76	32411	196	32542	209
31991	247	32315	76	32412	196	32543	209
31992	247	32316	122	32413	196	32544	209
31993	247	32317	122	32414	196	32545	209
31994	247	32318	311	32415	196	32546	210
31995	247	32319	281	32416	196	32547	213
	<b>32...</b>	32320	281	32417	196	32548	210
32045	249	32322	281	32418	196	32549	210
32046	250	32323	281	32419	196	32550	209
32055	249	32324	281	32420	196	32551	209
32057	250	32325	311	32421	196	32552	209
32058	250	32326	311	32422	196	32553	210
32059	250	32327	312	32423	196	32554	210
32060	249	32328	281	32424	196	32555	211
32061	249	32329	312	32477	205	32556	213
32062	249	32330	283	32484	218	32557	211
32070	250	32332	283	32486	196	32558	213
32071	250	32333	282	32490	195	32559	213
32105	195	32334	312	32491	195	32560	213
32151	73	32335	312	32492	195	32561	213
32152	73	32336	312	32493	195	32562	213
32153	73	32337	313	32494	195	32563	213
32154	73	32338	313	32495	195	32564	213
32155	73	32339	282	32496	195	32565	213
32156	73	32340	313	32497	195	32566	213
32157	73	32341	282	32499	187	32567	213
32160	207	32342	284	32500	187	32573	213
32160	218	32343	311	32501	187	32629	211
32161	218	32344	313	32502	187	32630	211
32179	35	32345	283	32503	187	32645	193
32180	35	32346	312	32504	187	32646	193
32201	71	32347	311	32505	202	32647	193
32249	24	32349	313	32508	210	32648	193
32250	18	32352	284	32509	210	32649	193
32251	18	32354	20	32510	210	32650	193
32252	18	32355	20	32511	210	32651	193
32253	18	32356	20	32512	210	32652	193

# Wiha list of order numbers.

Order-No.		Order-No.		Order-No.		Order-No.	
32653	193	33232	346	33729	197	33971	317
32654	193	33254	261	33730	197	<b>34...</b>	
32655	193	33256	261	33731	197	34005	193
32656	193	33259	263	33732	197	34006	193
32657	193	33260	261	33736	224	34007	193
32658	193	33391	145	33738	224	34008	193
32659	193	33471	304	33739	224	34009	193
32660	193	33472	304	33740	224	34010	193
32661	193	33503	123	33741	224	34011	193
32662	193	33503	203	33742	224	34268	136
32663	193	33504	328	33743	224	34269	136
32664	193	33505	329	33744	224	34270	136
32665	193	33506	329	33745	224	34271	136
32666	193	33507	309	33746	224	34272	136
32667	193	33520	274	33747	224	34273	136
32668	193	33521	306	33749	153	34274	136
32669	193	33660	346	33750	153	34275	136
32670	193	33663	235	33751	153	34276	136
32671	193	33666	184	33752	153	34277	136
32672	193	33667	184	33753	150	34306	216
32686	195	33668	184	33754	150	34307	281
32687	195	33669	184	33764	224	34308	281
32688	195	33670	184	33765	216	34309	281
32689	195	33671	184	33841	277	34310	283
32690	193	33672	246	33842	278	34311	282
32804	196	33673	246	33843	277	34312	284
32805	251	33674	246	33844	277	34313	283
32806	251	33675	246	33845	277	34452	196
32807	251	33676	246	33846	278	34453	196
32808	251	33677	247	33847	278	34454	196
32809	251	33678	247	33848	123	34455	196
32818	210	33679	247	33848	203	34456	196
32867	15	33695	186	33855	249	34457	196
32868	15	33696	186	33856	249	34483	249
32869	15	33697	186	33857	250	34484	249
32870	15	33698	186	33858	250	34485	249
32871	15	33699	186	33859	251	34486	250
32901	222	33700	186	33860	251	34487	250
32902	222	33701	186	33861	251	34488	250
32903	222	33702	186	33862	251	34489	251
32904	222	33703	195	33863	251	34490	251
<b>33...</b>		33704	195	33864	251	34491	251
33007	222	33705	195	33910	276	34492	251
33008	222	33706	195	33920	197	34493	251
33009	222	33707	195	33921	197	34494	251
33010	222	33708	195	33922	197	34495	346
33142	319	33709	197	33923	197	34515	281
33143	319	33710	197	33924	197	34516	282
33144	319	33711	197	33925	197	34517	282
33148	321	33712	197	33926	197	34518	284
33149	321	33713	197	33927	197	34533	89
33151	322	33714	197	33928	197	34554	198
33152	322	33715	197	33929	197	34555	198
33153	323	33716	197	33930	197	34556	198
33154	323	33717	197	33931	197	34557	198
33155	324	33718	197	33932	197	34558	198
33177	287	33719	197	33945	346	34559	198
33178	286	33720	197	33946	346	34560	198
33179	325	33721	197	33961	195	34565	281
33180	325	33722	197	33962	195	34566	281
33181	328	33723	197	33963	195	34567	281
33182	324	33724	197	33964	195	34568	283
33183	326	33725	197	33965	195	34569	281
33184	327	33726	197	33966	195	34570	281
33186	286	33727	197	33969	320	34571	282
33230	212	33728	197	33970	317	34572	282

<b>Order-No.</b>		<b>Order-No.</b>		<b>Order-No.</b>		<b>Order-No.</b>	
34573	282	34702	298	35479	287	36071	57
34577	57	34703	298	35480	136	36071	94
34578	57	34704	298	35481	136	36072	17
34578	94	34705	298	35482	136	36073	17
34579	57	34706	298	35483	136	36078	60
34579	94	34707	298	35484	136	36078	97
34580	57	34708	299	35485	136	36079	95
34580	94	34729	291	35486	136	36080	96
34581	57	34730	291	35487	136	36082	250
34581	94	34733	58	35488	136	36084	112
34582	57	34734	58	35489	136	36085	17
34582	94	34735	58	35490	136	36086	250
34583	57	34736	155	35501	51	36088	58
34583	94	34737	155	35502	51	36089	58
34584	57	34738	155	35503	51	36090	58
34584	94	34740	150	35504	51	36092	216
34585	57	34741	150	35505	51	36093	216
34585	94	34742	151	35506	57	36094	216
34586	57	34743	273	35506	94	36095	116
34586	94	34744	273	35507	57	36114	44
34587	57	34745	71	35507	94	36129	138
34587	94	34746	251	35508	57	36130	134
34588	57	34747	251	35508	94	36131	138
34588	94	34748	251	35509	57	36151	40
34589	57	34749	251	35509	94	36161	217
34589	94	34750	251	35510	57	36162	198
34590	57	34751	251	35510	95	36163	198
34590	94	34752	251	35511	57	36165	236
34614	88	34753	131	35511	95	36166	236
34664	164	34754	131	35538	279	36167	222
34665	164	34755	131	35555	17	36173	250
34666	164	34756	131	35556	59	36189	293
34667	164	34757	131	35557	59	36205	17
34668	164	34758	131	35558	59	36217	291
34669	164	34759	131	35559	53	36218	298
34670	164	34760	131	35560	53	36219	298
34671	164	34761	131	35683	136	36220	298
34672	164	34762	131	35704	273	36221	298
34673	164	34763	131	35705	273	36222	297
34674	164	34764	131	35709	250	36223	297
34675	164		<b>35...</b>	35820	304	36224	297
34676	164	35378	71	35832	251	36225	297
34677	164	35387	250	35834	249	36226	297
34678	164	35388	250	35861	274	36229	89
34679	165	35389	52	35862	274	36230	89
34680	165	35390	51	35870	93	36231	89
34681	165	35391	51	35969	279	36233	89
34682	165	35392	51		<b>36...</b>	36234	89
34683	165	35393	51	36035	282	36235	89
34684	165	35394	51	36036	282	36236	89
34685	165	35395	51	36037	282	36237	89
34686	245	35396	51	36038	284	36238	89
34688	297	35397	17	36039	284	36239	89
34689	297	35398	17	36040	284	36240	89
34690	297	35399	17	36041	284	36272	297
34691	297	35400	200	36050	278	36274	249
34692	297	35401	200	36051	279	36275	249
34693	297	35402	200	36052	279	36276	249
34694	297	35403	200	36053	279	36277	249
34695	297	35446	51	36063	275	36278	249
34696	297	35456	195	36064	299	36279	249
34697	297	35457	195	36065	284	36280	249
34698	298	35462	286	36066	269	36281	249
34699	298	35464	287	36068	60	36282	250
34700	298	35465	286	36069	60	36283	250
34701	298	35477	286	36070	60	36284	250

# Wiha list of order numbers.

Order-No.		Order-No.		Order-No.		Order-No.	
36285	250	36641	325	36829	249	36990	243
36286	250	36642	325	36830	249	<b>37...</b>	
36288	251	36643	325	36831	250	37067	344
36310	246	36644	325	36832	250	37094	97
36320	89	36645	325	36833	250	37145	344
36321	89	36646	325	36834	252	37147	57
36326	60	36647	325	36835	252	37147	95
36327	197	36648	325	36836	252	37196	230
36329	51	36649	325	36837	252	37197	230
36330	51	36650	325	36838	251	37198	233
36331	52	36659	324	36839	251	37199	233
36332	52	36660	324	36840	251	37200	231
36333	52	36661	324	36841	251	37201	233
36384	217	36662	324	36842	251	37217	156
36388	318	36663	324	36843	251	37222	57
36390	319	36664	324	36846	89	37222	95
36393	223	36665	324	36847	89	37223	57
36394	223	36666	328	36848	89	37223	95
36395	223	36667	328	36849	88	37224	57
36396	253	36668	328	36850	88	37224	95
36413	90	36669	328	36851	98	37225	57
36414	90	36670	328	36852	98	37225	95
36415	90	36671	328	36886	87	37226	57
36416	90	36672	328	36887	87	37226	95
36417	90	36673	326	36888	87	37227	57
36418	90	36674	326	36919	229	37227	95
36419	90	36675	326	36920	229	37309	344
36421	90	36676	326	36921	229	37318	229
36422	90	36677	326	36922	230	37319	232
36423	90	36678	326	36923	230	37325	230
36449	143	36679	326	36924	232	37326	233
36450	141	36680	326	36925	232	37351	133
36451	141	36681	326	36926	232	37352	133
36452	137	36682	326	36927	232	37402	293
36453	139	36683	327	36928	233	37403	293
36454	139	36684	327	36929	236	37419	344
36455	52	36685	327	36930	217	37450	274
36456	157	36686	327	36931	211	37871	70
36457	156	36687	327	36932	223	37872	70
36458	157	36688	327	36933	223	<b>38...</b>	
36459	157	36689	327	36934	229	38004	90
36460	156	36690	327	36935	229	38021	229
36461	156	36691	327	36936	229	38029	232
36462	157	36692	327	36937	230	38035	231
36483	292	36711	288	36938	230	38060	291
36486	153	36791	96	36939	232	38074	93
36487	153	36794	304	36940	232	38162	39
36503	149	36800	216	36941	232	38189	282
36504	149	36800	253	36942	232	38190	266
36517	71	36812	249	36943	233	38191	272
36521	135	36813	249	36951	236	38203	177
36522	135	36814	249	36975	297	38204	177
36536	51	36815	250	36976	297	38205	177
36537	51	36816	250	36977	298	38206	177
36538	51	36817	250	36978	298	38207	177
36539	51	36818	252	36979	298	38208	177
36540	51	36819	252	36980	298	38209	177
36541	51	36820	252	36981	291	38210	177
36542	51	36821	252	36982	282	38211	177
36543	325	36822	251	36983	282	38212	177
36544	325	36823	251	36984	282	38213	177
36553	90	36824	251	36985	284	38214	177
36558	53	36825	251	36986	284	38215	177
36586	325	36826	251	36987	284	38216	177
36639	325	36827	251	36988	284	38217	177
36640	325	36828	249	36990	231	38218	177



Order-No.	
38219	177
38220	177
38221	177
38222	177
38223	177
38224	177
38225	177
38226	177
38227	177
38228	177
38229	177
38230	177
38231	177
38232	177
38233	177
38234	177
38361	55
38362	53
38370	197
38371	197
38372	197
38438	177
38439	177
38552	273
38556	107
38557	107
38558	107
38588	226
38589	226
38590	226
38591	226
38592	226
38593	226
38594	226
38595	226
38596	226
38597	226
38598	226
38599	226
38600	225
38601	225
38602	225
38603	225
38604	225
38605	225
38606	225
38607	225
38608	225
38609	225
38610	55
38611	55
38612	55
38613	55
38616	107
38617	107
38618	107
38619	107
38620	107
38621	107
38622	107
38627	292
38631	274
38632	274
38633	287
38634	287
38635	287

Order-No.	
38636	287
38637	288
38638	288
38798	279
38800	107
38801	107
38802	107
38803	107
38804	107
38805	107
38806	107
38807	107
38808	107
38809	107
38810	107
38811	107
38812	107
38813	107
38814	107
38815	107
38816	107
38817	107
38818	107
38819	107
38820	107
38821	107
38837	38
38838	38
38839	38
38840	38
38842	38
38843	38
38853	273
38854	292
38855	286
38856	286
38857	286
38858	286
38859	286
38860	287
38861	287
38862	287
38863	287
38864	287
38865	287
38866	287
38867	288
38874	69
38875	69
38876	69
38877	69
38878	69
38879	69
38880	69
38881	69
38890	102
38891	102
38892	102
38893	102
38896	102
38897	102
38898	102
38899	102
38914	111
38915	227
38916	227

Order-No.	
38918	67
38918	105
38919	67
38919	105
38920	67
38920	105
38921	67
38921	105
38925	67
38925	105
38926	67
38926	105
38927	67
38927	105
38928	67
38928	105
38929	67
38929	105
38930	67
38930	105
38931	67
38931	105
38932	67
38932	105
38933	67
38933	105
38934	67
38934	105
38935	67
38935	105
38936	67
38936	105
38981	291
38982	282
38983	266
38984	272
38985	274
38986	274
38996	69
38997	58
<b>39...</b>	
39008	338
39010	338
39012	338
39014	338
39017	339
39019	339
39021	339
39022	339
39029	240
39031	238
39032	238
39033	239
39034	237
39035	242
39036	239
39037	241
39038	242
39039	241
39040	240
39041	240
39043	239
39044	238
39045	241
39046	237
39047	242

Order-No.	
39048	242
39049	240
39050	239
39051	238
39052	238
39053	237
39054	242
39055	239
39056	241
39057	241
39058	242
39059	241
39060	240
39061	240
39063	239
39064	238
39065	237
39066	242
39067	242
39069	67
39076	44
39077	239
39078	240
39079	237
39080	237
39081	239
39082	241
39083	240
39084	237
39085	237
39086	243
39087	243
39088	243
39089	243
39090	243
39091	294
39093	267
39094	294
39095	267
39104	154
39105	154
39106	154
39107	154
39108	154
39109	154
39110	154
39111	154
39112	154
39113	154
39114	154
39115	154
39116	154
39117	154
39118	154
39124	241
39125	117
39133	216
39133	252
39134	216
39134	252
39135	227
39136	227
39137	227
39138	227
39149	339
39150	339

# Wiha list of order numbers.

Order-No.		Order-No.		Order-No.		Order-No.	
39151	339	39224	199				
39152	339	39225	199				
39160	177	39226	199				
39161	177	39227	199				
39162	177	39228	199				
39163	177	39229	199				
39164	177	39230	199				
39165	177	39231	199				
39166	177	39232	199				
39167	177	39233	199				
39168	177	39234	199				
39169	177	39235	199				
39170	177	39236	199				
39171	177	39237	199				
39172	177	39238	199				
39173	177	39239	199				
39174	177	39240	199				
39175	177	39241	199				
39176	177	39255	104				
39177	177	39255	113				
39178	198	39255	227				
39179	198	39256	104				
39180	198	39256	113				
39181	198	39256	227				
39182	198	39257	104				
39183	198	39257	113				
39184	197	39257	227				
39185	197	39369	102				
39186	197	39370	105				
39187	197	39383	113				
39188	197	39383	227				
39189	197						
39190	197						
39191	197						
39192	197						
39193	197						
39194	197						
39195	196						
39196	196						
39197	196						
39198	196						
39199	196						
39200	196						
39201	196						
39202	196						
39203	196						
39204	196						
39205	131						
39206	197						
39207	197						
39208	197						
39209	199						
39210	199						
39211	199						
39212	199						
39213	199						
39214	199						
39215	199						
39216	199						
39217	199						
39218	199						
39219	199						
39220	199						
39221	199						
39222	199						
39223	199						

# iPOSS – Perfect Presentation





# Best Practice Compositions



# New iPOSS Modules

## New iPOSS Modules

Leverage on the new flexibility of modules.

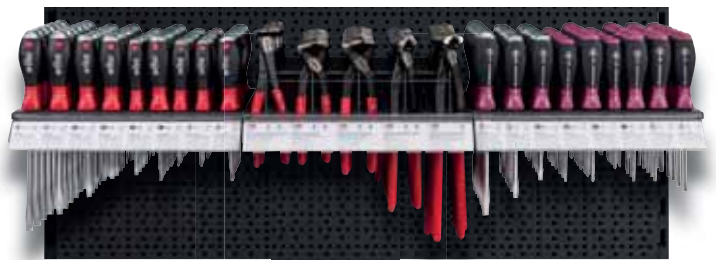



# Sales Panel. Design it Yourself.

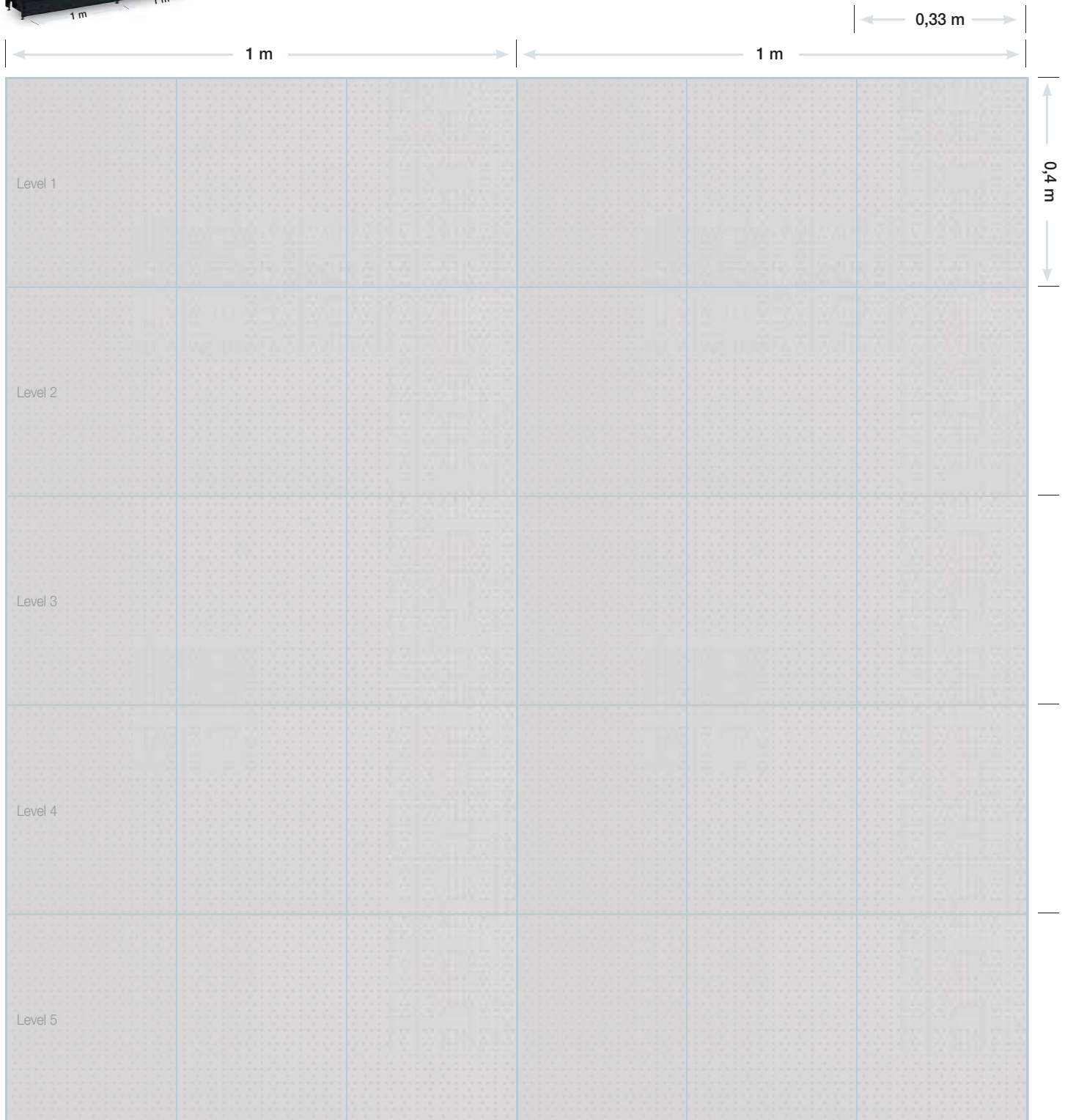
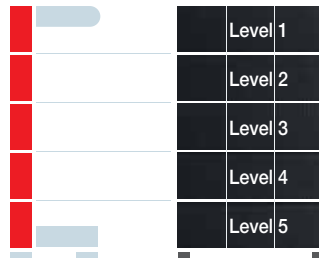

# Wiha General Terms of trading.

## Terms and conditions of sale, delivery and payment. Effective as of March 2007.

**1. Validity.** These terms and conditions shall be binding in respect of all orders. Any departures from them or secondary verbal agreements shall be valid only if confirmed by us in writing. We will not accept the terms and conditions of the customer even if we do not expressly refuse to accept them. By placing his order the customer acknowledges our terms and conditions. Events beyond our reasonable control and instances of force majeure shall release us from commitments entered into.

**2. Offers.** All offers are made without obligation. Our currently valid catalogues or price lists form an integral part of our offers. Samples are invariably supplied against payment.

**3. Orders.** Orders shall not be deemed accepted by us until we have confirmed them in writing. This provision shall also apply to orders taken by our representatives. The acceptance of an order does not place us under any obligation to accept follow-on orders under the same conditions.

**4. Prices.** Prices are quoted in Euros (€), excluding value-added tax at the statutory rate. Prices are quoted without obligation and are applicable to delivery ex works, excluding packaging. If the agreed delivery date is more than 6 weeks after the time the purchase agreement is concluded, we reserve the right to make appropriate adjustments to our prices due to general increases in wage, material or marketing costs or if higher rates of public taxes and similar charges are imposed. All prices are basic prices; in the event of resale by the trade, however, they are non-binding target prices and do not constitute a price recommendation.

**5. Delivery.** All deliveries are made at the risk of the consignee even if delivery is agreed carriage paid to destination. Deliveries shall be made for the account of the consignee. We will effect delivery using the method of shipment considered most suitable for the goods in question. For small orders up to a net value of EUR 300.00, we will invoice an administration and delivery fee of EUR 6.00. Goods with a net value of EUR 500.00 or more will be supplied to foreign customers free to the German border or FOB German sea port, including packaging. Deliveries of goods with a lower value will be made ex works excluding packaging. In the case of orders that do not conform to our packaging units we reserve the right to deliver the goods in a manner compatible with our packaging units, otherwise a surcharge of 10% will be

charged.

**6. Delivery lead time.** As a general rule, we deliver all articles listed in our catalogue ex warehouse or within a few days. In all other cases, we will state the anticipated delivery lead time, which depends on our workload; however, we shall not be bound by the lead time quoted. If the lead time is exceeded by us the customer may, to the exclusion of all other claims, withdraw from the contract upon the lapse of a reasonable extension allowed by him. Partial deliveries shall be permitted. If performance is delayed for reasons attributable to the customer, we shall not be bound by our delivery dates. If the customer does not take remedial action immediately, we shall be entitled to claim compensation for the additional costs incurred by us or withdraw from the contract after the lapse of a reasonable extension.

**7. Terms of payment.** Our invoices are payable within 10 days of the date of the invoice less 2% discount or net within 30 days from the invoice date. Invoices for goods with a value of less than EUR 50.00 are due for payment immediately and without any deductions. Payments by cheque, bank transfers or cash payments made against presentation of a bill made out by us and accepted by the customer shall be deemed to have been effected after the bill has been honoured by the drawee thus discharging us from any liability under the bill. The agreed reservation of title shall remain effective in our favour until the bill has been collected.

**8. Property rights.** We reserve title and copyright in illustrations, drawings and other documentation.

### **9. Reservation of title.**

**9.1** All deliveries will be made with reservation of title. The products delivered (reserved goods) shall remain our property until the customer has met all his obligations arising from the contractual relationship with us. The risk of loss of or damage to the reserved goods shall be borne by the customer, also during the period this reservation of title is effective.

**9.2** During the time this reservation of title is effective the customer shall not be entitled to pledge the reserved goods or to assign them by way of security. The customer is entitled to sell the goods owned by us (reserved goods) in the normal course of business. However, the customer already cedes all accounts receivable from this resale to us.

**9.3** Processing or alteration of the reserved goods is without obligation to us as a manufacturer as per Section 950 of

the German Civil Code. If the reserved goods are processed together with other objects, we shall acquire a co-ownership in the new object in the ratio of the current market value of our goods to the value of the other processed objects at the time of processing. The customer will store the new object for us with due care and attention free of charge.

**9.4** If the value of all security interests we are entitled to exceeds the amount of all secured claims by more than 20%, we will release a corresponding portion of the security interests at the written request of the customer.

**9.5** The customer shall inform us without delay in case of garnishments, confiscations or other court orders or interventions by third parties.

**9.6** If the customer violates contractual obligations, particularly if the customer is in payment default, we shall be entitled, after an appropriate deadline that we set for the customer to make payment lapses without success, to withdraw from the contract and demand the return of our goods. The legal provisions regarding the dispensability of setting a deadline shall remain unaffected. The customer shall be obligated to surrender the goods.

**10. Warranty for defects.** The customer shall be entitled to warranty claims under fully commercial business transactions only if he has discharged his obligations in respect of examination and notification of defects without delay and as prescribed by Section 377 of the German Commercial Code (HGB). Any defects in the purchased goods for which we are responsible shall be repaired or a replacement supplied, at our discretion. The warranty refers to the condition of the goods upon delivery. Subsequent damage due to normal aging, wear or excessive use is not covered by the warranty.

Liability for harm to life, limb and health due to a culpable breach of obligations by us, one of our legal representatives or one of our agents shall neither be excluded nor limited. We shall be liable for such harm on the part of our contractual partner only if said harm was due to an intentional or grossly negligent breach of obligations by us, one of our legal representatives or one of our agents. If we caused the harm only due to simple negligence, we shall be liable only if the harm was due to a violation of key contractual obligations, limited to the harm that is reasonably foreseeable and typical for this type of contract.

Further claims by the customer shall be excluded, irrespective of their legal grounds. The exclusions of liability shall also apply in all cases to consequential damage. The above exclusions of liability

to not apply to claims based on the Product Liability Act.

**11. Returns.** Perfectly packaged goods from the current catalogue which do not require any further processing will be credited with a deduction of up to 20% of the corresponding order value.

**12. Dimensions and weights.** The dimensions, drawings and illustrations contained in offers, brochures, catalogues and price lists shall not be binding and may be modified by us without further notice. All dimensions are quoted in mm and all weights in g.

**13. Special manufacture.** In the case of special manufacture, we reserve the right to deliver up to 10% more or less. Orders for special products cannot be cancelled. The same provision shall also apply to series production articles if they were ordered with a special symbol or special marking.

**14. Place of performance and jurisdiction.** The place of performance for deliveries and payments shall be Schonach/Schwarzwald (Germany). All disputes arising from the business relationship shall be referred to the court under whose jurisdiction Schonach falls.

### Subject to technical changes.

All illustrations and graphics, specified dimensions and values and references to standards, e.g. DIN/EN, are non-binding. Any liability claims based on this will therefore be rejected.

No liability claims will be accepted for printing errors and mistakes which have occurred during the production of the catalogue.

All property rights to the catalogue held by Wiha Werkzeuge GmbH are reserved. The printing or copying of the texts and illustrations contained in this catalogue or its design is prohibited.

Our General Terms and Conditions (Terms of Sale, Delivery and Payment) apply.

TORX®, TORX PLUS® = Registered Trademarks of ACUMENT Global Technologies B.V.

ACR/AOT, Tri-Wing®, Torq-Set® = Registered Trademarks of Phillips Screw Company

Pozidriv = Registered Trademark of European Industrial Services Ltd.

# Wiha information system

## Wiha product information.

On these pages you will find important information you need to know to use and order our products correctly and easily.

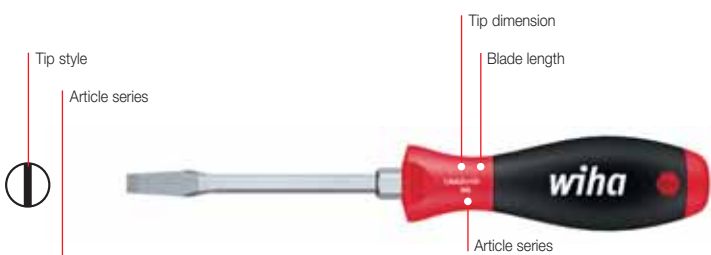

308

### SoftFinish® slotted screwdriver. Hex blade with hex bolster.

Blade: High quality chrome-vanadium-molybdenum steel, through hardened, chrome-plated.

Wiha ChromTop® finish on tip for a perfect fit every time.

Handle: Ergonomic Wiha SoftFinish® multi-component handle with roll-off protection.

Standards: DIN 5265, ISO 2380.

Application: Especially for dry and general applications.

Order-No.	⌀	↔	⊖	⬡	⬡	↔	⊕	⊕
00731	3,5	75	0,6	4,0	-	186	30	10
00732	4,5•	90	0,8	4,0	-	201	30	10
00733	5,5	100	1,0	5,0	8	213	36	10
00734	6,5	125	1,2	6,0	10	238	36	10

• Additional dimension. Non-DIN size.

Order number

Tip dimension (mm)

Blade length (mm)

Tip width (mm)

Blade dimension (mm)

Hex bolster (mm)

Total length (mm)

Handle diameter (mm)

Packaging unit =  
Minimum quantity

For your order

Article information

## Wiha product search system.

The catalogue contains five different search systems:

### 1. Product groups.

On page 5 you will find an overview of all product groups.

### 2. Based on product lines.

You can find a short summary based on product lines on page 4.

### 3. Tips styles.

On pages 324 to 325 you will find a matrix with all tip styles.

### 4. Order number.

On pages 334 to 341 you will find all order numbers in a numerical index.

### 5. Series number.

On pages 342 to 343 you will find an overview of the Wiha article series in a numerical index.

# Symbols key

## Profile

	Triangular nut
	Nut driver
	Square nut
	Hex
	Hex with hole (Tamper Resistant)
	Hex with pivot
	Square
	IPR (TORX PLUS® Security)
	Countersink
	Combination drill
	Phillips PH
	Pozidriv PZ
	Robertson
	Rondblade
	Slotted
	Slotted nut
	SIT
	Spanner
	Twist drill
	Sliding sleeve
	Torq-Set®
	TORX®
	TORX® Tamper Resistant
	TORX PLUS®
	Tri-Wing®
	Multitooth
	Square reaming blade

## Drive

	Square nut
	Drive system G7
	Combination drill
	SDS-Plus®
	Hex

## Screwdrivers [mm]

	Tip dimension
	Tip width
	Blade dimension
	Blade dimension
	Hex bolster
	Scraper width
	Tip gap
	Tip width
	Small head diameter
	Large head diameter
	Reversible blade length
	Reversible blade length
	Adapter reversible blade length
	Bit holder
	Blade length
	Total length
	Handle width
	Blade length
	Arm length
	Total length
	Handle length
	Handle diameter
	Top-handle length
	Top-handle width
	Torque T-handle length
	Torque T-handle width
	Max. torque [Nm]
	Max. torque [in.lbs]
	Accuracy in percent
	Depth cable key

## Hex L-keys [mm]

	Blade dimension
	Blade dimension
	Hex bolster
	Total length
	Arm length
	Blade length
	Side driver length
	Total length
	Handle width
	Handle diameter
	Total length
	Arm length

## Bits [mm]

	Blade diameter
	Bit length
	Threaded bit
	Bit holder length
	Total length
	Flute length
	Screw size
	Bit holding socket length
	Socket length

## Pliers [mm]

	Flat jaws
	Half round jaws
	Round jaws
	Cutter without bevel
	Cutter with smallbevel
	Cutter with bevel
	Anvil cutter
	Center cutter
	Scissors cutter
	Stripper
	Pliers length [mm]
	Pliers length [inch]
	Soft wire
	Medium hard wire
	Hard wire
	Piano wire
	Max. diameter
	Max. cross-section
	Max. gripper pipe diameter
	Max. gripper width across flats
	Retaining ring, external
	Retaining ring, internal
	Clamping range
	Opening width, flat

## Soft-face hammer [mm]

	Face diameter
	Face width
	Hammer head width
	Total length

## Measurement tools [mm]

	Scale width
	Colour
	Measurement capacity [mm]
	Measurement capacity [inch]
	Segment quantity
	Max. length, assembled
	Flat nozzle width
	Threaded connector

## General symbols

	Weight [g]
	Packaging unit

**Wiha Werkzeuge GmbH**

Obertalstraße 3-7  
78136 Schonach/Germany  
Tel. +49 7722 959-0  
Fax +49 7722 959-159  
info@wiha.com  
www.wiha.com

**Wiha Tools Ltd.**

17 The Courtyard  
Buntsford Gate  
Bromsgrove, Worcs, B60 3DJ.  
Tel. +44 1527 57 57 58  
+44 1527 91 09 86  
Fax +44 1527 91 00 23  
info.uk@wiha.com  
www.wiha.com/en

**Wiha France SARL**

Z. A. de Terrefort  
F-33520 Bruges/France  
Tel. +33 5 56 16 79 35  
Fax +33 5 56 16 79 36  
servicecommercial@wiha.fr  
www.wiha.com/fr

**Wiha Nordic A/S**

Korskildelund 6  
DK-2670 Greve  
Tel. +45 70 23 80 45  
Fax +45 70 23 80 46  
info.nordic@wiha.com  
www.wiha.com/en-sv

**Wiha Iberia**

Av. del Rey Juan Carlos I, 98. 3º C  
E-28916 Leganés/Madrid  
Tel. +34 91 693 85 11  
Fax +34 91 693 63 83  
iberia@wiha.com  
www.wiha.com/es

**Wiha Polska Sp. z o.o.**

ul. Budowlanych 10 b  
PL-80-298 Gdańsk  
Tel. +48 58 762 38 30  
Fax +48 58 762 39 00  
info.pl@wiha.com  
www.wiha.com/pl

**Wiha in Russia**

Tel. +48 58 762-38-30  
Fax +48 58 762-39-00  
michal.moczynski@wiha.com  
www.wiha.com

**Willi Hahn Corp.**

1348, Dundas Circle  
Monticello, MN 55362/USA  
Tel. +1 763 2 95 65 91  
Fax +1 763 2 95 65 98  
cservice@wihatools.com  
www.wihatools.com

**Wiha Tools Canada Ltd.**

249 Summerlea Road  
L6T 4X4 Brampton, ON  
Tel. +1 763 295 6591  
Fax +1 763 295 6598  
mihran@wihatools.com  
www.wihatools.com.ca

**Wiha Asia Pacific Pte. Ltd.**

25 International Business Park  
#02 – 102 German Centre  
Singapore 609916 / Singapore  
Tel. +65 6563 1277  
Fax +65 6563 7168  
info.sg@wiha.com  
www.wiha.com.sg

**Wiha Tools (Shanghai) Co.Ltd.**

Rm14B Zhaofeng Universe Building  
1800 Zhongshanxi Road  
Shanghai 200235/China  
Tel. +86 21 6440 1119  
Fax +86 21 6440 1112  
info@wihachina.com  
www.wihachina.com

**Wiha Tools (India) Pvt. Ltd**

Jivan Vihar, 2nd Floor, 18,  
Modi Street, Fort  
Mumbai – 400001  
Maharashtra, India  
Tel. +91 22 2269 4414  
Fax +91 22 2269 8936  
info.in@wiha.com  
www.wiha.com

**Wiha en Belgique**

Tel. +32 49 35 054 50  
info.belux@wiha.com  
www.wiha.com

**Wiha Italia S.R.L**

Largo Guido Donegani 2  
20121 Milano/Italia  
info.it@wiha.com  
www.wiha.com