

PLEASE CHECK WWW.MOLEX.COM FOR LATEST PART INFORMATION

Part Number: [1053251002](#)
Status: **Active**
Overview: [Nano-Fit Power Connectors](#)
Description: Nano-Fit Terminal Position Assurance (TPA) Retainer, 2.50mm Pitch, 2 Circuits, Black

Documents:

3D Model	Test Summary 1053000000-TS-000 (PDF)
Drawing (PDF)	RoHS Certificate of Compliance (PDF)
Product Specification PS-105300-100-001 (PDF)	Product Literature (PDF)
Packaging Specification PK-105325-100-000 (PDF)	

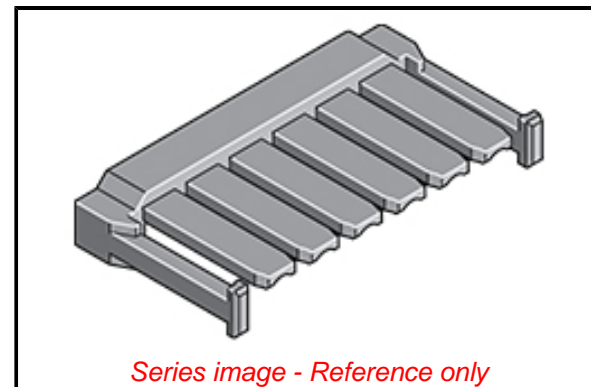

General

Product Family	Accessories
Series	105325
Comments	Operating temperature is -40#C to +105#C for tin and -40#C to +115#C for gold, Operating temperature is -40#C to +105#C for tin and -40#C to +115#C for gold
Component Type	Terminal Position Assurance
Overview	Nano-Fit Power Connectors
Product Literature Order No	987651-1223
Product Name	Nano-Fit, TPA - Term Pos Assurance
UPC	889056028554

Physical

Circuits (Loaded)	2
Circuits (maximum)	2
Color - Resin	Black
Lock to Mating Part	Yes
Material - Resin	Nylon
Net Weight	0.080/g
Number of Rows	1
Packaging Type	Bag
Temperature Range - Operating	-40° to +105°C, -40° to +115°C

Material Info

Reference - Drawing Numbers

Packaging Specification	PK-105325-100-000
Product Specification	PS-105300-100-001
Sales Drawing	SD-105325-100-000
Test Summary	1053000000-TS-000

EU ELV

Not Relevant

EU RoHS

Compliant

REACH SVHC

Not Contained Per
-ED/88/2018 (15
January 2019)

Halogen-Free

Status

Low-Halogen

For more information, please visit [Contact US](#)

China ROHS

ELV

RoHS Phthalates

China RoHS

Green Image

Not Relevant

Not Contained

Search Parts in this Series

[105325 Series](#)

Use With

Nano-Fit TPA Receptacle Housing [105307](#) ,
[105308](#)