

KEMET Part Number: CAN12X153KARACTU
(CAN12X153KARAC7800)

AC SMD X7R Flex, Ceramic, Non-safety, 0.015 uF, 10%, 250VAC, X7R, SMD, MLCC, Industrial, 1206

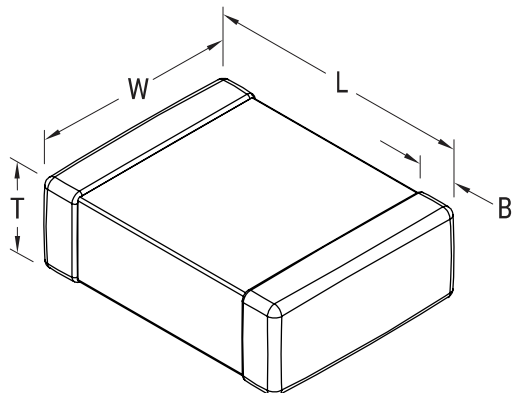

Dimensions

L	3.3mm +/-0.4mm
W	1.6mm +/-0.35mm
T	1.7mm +/-0.20mm
B	0.6mm +/-0.25mm

Packaging Specifications

Packaging:	T&R, 180mm, Plastic Tape
Packaging Quantity:	2000

General Information

Supplier:	KEMET
Series:	CAN SMD Indust X7R
Style:	SMD Chip
Description:	SMD, MLCC, AC Non-Safety
Features:	AC Non-Safety rated
RoHS:	Yes
Termination:	Flexible Termination
Marking:	No
Miscellaneous:	Note: Referee time for X7R dielectric for this part number is 1000 hours. X7R dielectric is not recommended for AC line filtering or pulse applications
Chip Size:	1206

Specifications

Capacitance:	0.015 uF
Capacitance Tolerance:	10%
Voltage AC:	250 VAC 50/60Hz
Dielectric Withstanding Voltage:	945 V
Temperature Range:	-55/+125C
Temperature Coefficient:	X7R
Dissipation Factor:	2.50% 1kHz 25C
Aging Rate:	3% Loss/Decade Hour
Insulation Resistance:	6.667 GOhms