

**PLEASE CHECK WWW.MOLEX.COM FOR LATEST PART INFORMATION**

**Part Number:** [0512812094](#)  
**Status:** **Active**  
**Overview:** [FFC-FPC \(SMT\)](#)  
**Description:** 0.50mm Pitch Easy-On FFC/FPC Connector, Surface Mount, Right-Angle, Non-ZIF, Dual Contact Style, 1.20mm Mated Height, 20 Circuits, Gold (Au) Plating

**Documents:**

[3D Model](#) [Packaging Specification SPK-51281-001-001 \(PDF\)](#)  
[Drawing \(PDF\)](#) [RoHS Certificate of Compliance \(PDF\)](#)  
[Product Specification PS-51281-003-001 \(PDF\)](#)

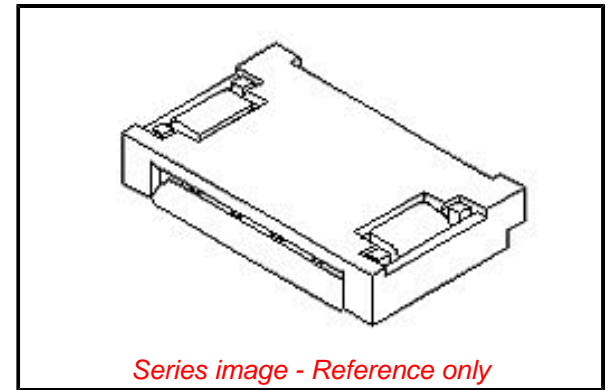

**General**

Product Family [FFC/FPC Connectors](#)  
Series [51281](#)  
Overview [FFC-FPC \(SMT\)](#)  
Product Name [Easy-On](#)  
UPC [822348699957](#)

**Physical**

Actuator Type [Non-ZIF](#)  
Circuits (Loaded) [20](#)  
Color - Resin [Natural](#)  
Contact Position [Dual](#)  
Durability (mating cycles max) [20](#)  
Mated Height [1.20mm](#)  
Material - Metal [Phosphor Bronze](#)  
Material - Plating Mating [Gold](#)  
Material - Plating Termination [Tin](#)  
Net Weight [119.559/mg](#)  
Number of Rows [1](#)  
Orientation [Right Angle](#)  
PCB Locator [No](#)  
PCB Mounting [Surface Mount](#)  
PCB Retention [Yes](#)  
Packaging Type [Embossed Tape on Reel](#)  
Pitch - Mating Interface [0.50mm](#)  
Plating min - Mating [0.102µm](#)  
Plating min - Termination [1.016µm](#)  
Polarized to PCB [Yes](#)  
Stackable [No](#)  
Surface Mount Compatible (SMC) [N/A](#)  
Temperature Range - Operating [-20° to +85°C](#)  
Wire/Cable Type [FFC/FPC](#)

**Electrical**

Current - Maximum per Contact [0.5A](#)  
Voltage - Maximum [50V](#)

**Material Info**

**Reference - Drawing Numbers**

[Packaging Specification](#) [SPK-51281-001-001](#)  
[Product Specification](#) [PS-51281-003-001](#)  
[Sales Drawing](#) [SD-51281-011, SD-51281-012](#)

**EU ELV**

**Not Relevant**

**EU RoHS**

**Compliant**

**REACH SVHC**

Not Contained Per  
-ED/88/2018 (15  
January 2019)

**Halogen-Free**

**Status**

**Low-Halogen**

For more information, please visit [Contact US](#)

China ROHS

ELV

RoHS Phthalates

**China RoHS**

Green Image

Not Relevant

Not Contained

**Search Parts in this Series**

[51281 Series](#)

**PLEASE CHECK [WWW.MOLEX.COM](http://WWW.MOLEX.COM) FOR LATEST PART INFORMATION**