

PLEASE CHECK WWW.MOLEX.COM FOR LATEST PART INFORMATION

Part Number: [0901303108](#)
Status: **Active**
Overview: [C-Grid III Interconnects](#)
Description: C-Grid III Header, Dual Row, Right-Angle, Shrouded, Fully Loaded, 8 Circuits, Black, 3µm Tin (Sn) over Nickel (Ni)

Documents:

3D Model	Packaging Specification PK-90130-001-001 (PDF)
Drawing (PDF)	Packaging Specification PK-91814-005 (PDF)
Product Specification PS-99020-0001-001 (PDF)	RoHS Certificate of Compliance (PDF)

Agency Certification

CSA	LR19980
UL	E29179

General

Product Family	PCB Headers
Series	90130
Application	Signal, Wire-to-Board
Overview	C-Grid III Interconnects
Product Name	C-Grid III
UPC	800753706859

Physical

Breakaway	No
Circuits (Loaded)	8
Circuits (maximum)	8
Color - Resin	Black
Durability (mating cycles max)	30
First Mate / Last Break	No
Flammability	94V-0
Glow-Wire Capable	No
Guide to Mating Part	No
Keying to Mating Part	None
Lock to Mating Part	Yes
Material - Metal	Brass
Material - Plating Mating	Tin
Material - Plating Termination	Tin
Material - Resin	Polyester
Net Weight	1.257/g
Number of Rows	2
Orientation	Right Angle
PC Tail Length	2.90mm
PCB Locator	No
PCB Retention	None
PCB Thickness - Recommended	1.60mm
Packaging Type	Tray
Pitch - Mating Interface	2.54mm
Pitch - Termination Interface	2.54mm
Plating min - Mating	3.048µm
Plating min - Termination	3.048µm
Polarized to Mating Part	Yes
Polarized to PCB	No
Shrouded	Closed Ends
Stackable	No
Surface Mount Compatible (SMC)	No
Temperature Range - Operating	-55° to +125°C

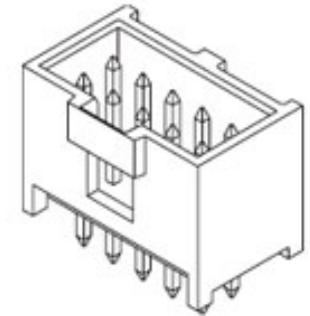

Series image - Reference only

EU ELV

Not Relevant

EU RoHS

Compliant

REACH SVHC

Not Contained Per
-ED/88/2018 (15
January 2019)

Halogen-Free

Status

Not Low-Halogen

For more information, please visit [Contact US](#)

China ROHS

ELV

RoHS Phthalates

China RoHS

Green Image

Not Relevant

Not Contained

Search Parts in this Series

[90130](#) Series

Mates With

[90142](#) C-Grid III Crimp Housing

Termination Interface: Style Through Hole

Electrical

Current - Maximum per Contact 3.0A
Voltage - Maximum 350V AC/DC

Solder Process Data

Duration at Max. Process Temperature (seconds) 003
Lead-freeProcess Capability WAVE
Max. Cycles at Max. Process Temperature 001
Process Temperature max. C 235

Material Info

Reference - Drawing Numbers

Packaging Specification PK-90130-001-001, PK-91814-005
Product Specification PS-99020-0001-001
Sales Drawing SDA-90130-001

This document was generated on 03/27/2019

PLEASE CHECK WWW.MOLEX.COM FOR LATEST PART INFORMATION