

# ECI motor.

## ECI-63.XX-K1



- Highly dynamic 3-phase internal rotor motor with EC technology
- Low cogging torque
- Robust, noise-optimized ball bearing system for a long service life
- High efficiency and high power density realized in a compact design
- Basic motor with electronic module K1 for operation with external control electronics
- Mechanical design and interfaces designed for modular flexibility
- Protection class IP 40 / IP 54 and connection by connector system

Nominal data							
Type		ECI-63.20-K1 -B00	ECI-63.20-K1 -D00	ECI-63.40-K1 -B00	ECI-63.40-K1 -D00	ECI-63.60-K1 -B00	ECI-63.60-K1 -D00
Nominal voltage ( $U_N$ )	V DC	24	48	24	48	24	48
Nominal speed ( $n_N$ )**	rpm	4 000					
Nominal torque ( $M_N$ )**	mNm	360	360	670	670	800	880
Nominal current ( $I_N$ )**	A	8.50	4.50	14.0	6.50	17.6	8.50
Nominal output power ( $P_N$ )**	W	150	150	280	280	335	370
Starting torque ( $M_{max}$ )	mNm	1 800	1 800	3 300	3 300	5 300	4 400
Permissible peak current ( $I_{max}$ )***	A	55	30	95	45	150	57
Speed at no-load operation ( $n_0$ )	rpm	5 800	6 800	5 900	5 900	6 100	6 000
No-load current ( $I_0$ )	A	0.50	0.30	0.70	0.32	1.30	0.45
Recommended speed control range	rpm	0 ... 5 000					
Rotor moment of inertia ( $J_R$ )	kgm <sup>2</sup> x10 <sup>-6</sup>	19	19	38	38	57	57
Motor constant ( $K_E$ )	mVs/rad	41.4	73.3	40.4	83.8	40.4	83.8
Connection resistance ( $R_N$ )	Ω	0.14	0.42	0.08	0.24	0.04	0.15
Connection inductance ( $L_N$ )	mH	0.26	0.88	0.14	0.57	0.09	0.33
Overload protection		To be implemented via the control electronics					
Permissible ambient temperature range ( $T_U$ )	°C	0 ... +40					
Weight	kg	0.90	0.90	1.20	1.20	1.50	1.50
Order no. (wire interface)*	IP 40	932 6320 103	932 6320 105	932 6340 103	932 6340 105	932 6360 106	932 6360 108
Order No. (connector interface)*	IP 54	932 6320 100	932 6320 102	932 6340 100	932 6340 102		932 6360 102
Subject to alterations		* Classification of protection class refers to installed state with sealing on the flange side The wave geometry for the IP54 version differs from the illustrated drawing ** At $T_U$ max. 40°C *** Permissible time for peak current: max. 1 sec. – to be repeated only after complete cool down					

**Characteristic curve**

ECI-63.20-K1, 24 V (at 25°C)

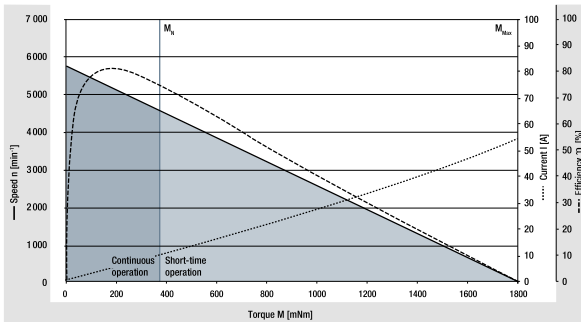

<sup>1)</sup> Nominal data, see table

Characteristic curve 48 V on request

ECI-63.40-K1, 24 V (at 25°C)

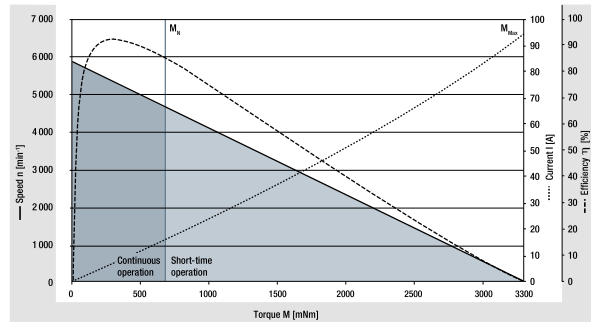

<sup>1)</sup> Nominal data, see table

Characteristic curve 48 V on request

ECI-63.60-K1, 24 V (at 25°C)

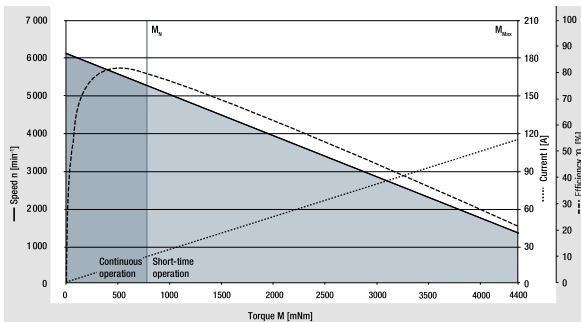

<sup>1)</sup> Nominal data, see table

Characteristic curve 48 V on request

# ECI motor.

## ECI-63.XX-K1

### Technical drawing Strand design

All dimensions in mm

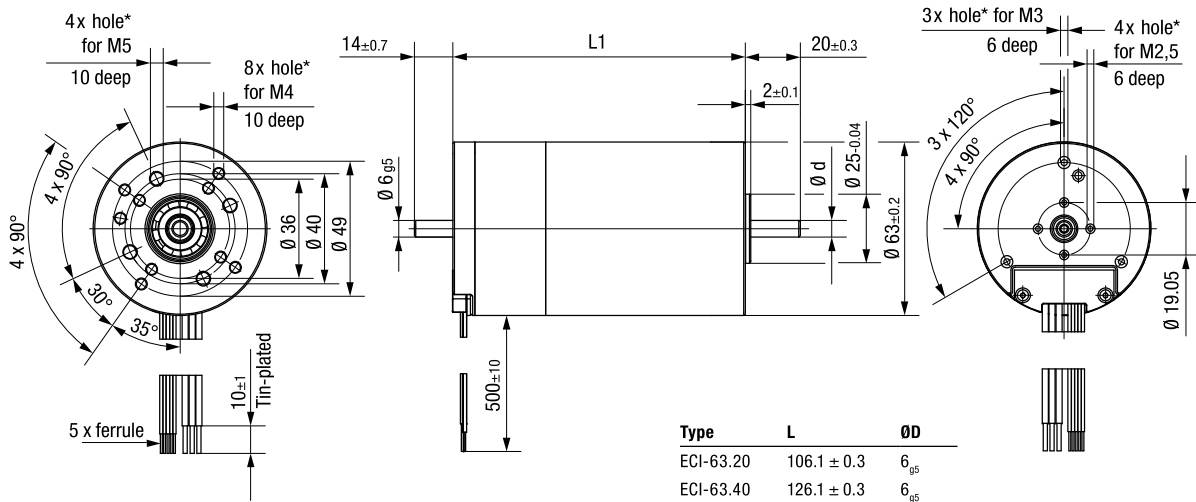

Type	L	ØD
ECI-63.20	106.1 ± 0.3	6 <sub>g5</sub>
ECI-63.40	126.1 ± 0.3	6 <sub>g5</sub>
ECI-63.60	146.1 ± 0.3	10 <sub>g5</sub>

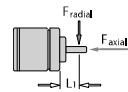

$F_{axial}$  150 N  
 $F_{radial}$  150 N  
 L1 20 mm  
 Permissible shaft load at nominal speed and life expectancy  $L_{10}$  (nominal operation) of 20 000 h (at  $T_U$  max. 40°C)

\* For thread-rolling screws according to DIN 7500

### Electrical connection

Supply wire		
Wire	Color	Function
1	yellow	Phase W
2	violet	Phase V
3	brown	Phase U

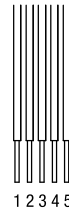

Signal wire		
Wire	Color	Function
4	green	Hall A
5	white	Hall B
6	gray	Hall C
7	red	$U_B$
8	black	GND

# Crown gearheads.

EtaCrown® 75



Image of 2-stage gearhead

- Maximum safety in design and operation, as well as optimal vandalism protection; no automatic lock due to high efficiency of the crown wheel technology
- Space-saving installation due to zero offset axle and symmetrical structure
- Flexible application possibilities with various optional shaft outlets and available shaft geometries
- Wide reduction range by means of upstream / downstream planetary stage
- High radial loads due to double ball bearing in the output shaft

Nominal data		EtaCrown® 75.1			EtaCrown® 75.2			
Gearheads								
Reduction ratio		4.10	6.70	10.1	20.3	33.3	60.0	113
No. of stages		1			2			
Efficiency		0.90			0.81			
Max. input speed (n <sub>i</sub> )	rpm	6 000			6 000			
Rated output torque (M <sub>ab</sub> )	Nm	6.00	5.00	2.43	10.0	10.0	10.0	10.0
Short-term torque (M <sub>max</sub> )	Nm	15.0	12.5	6.08	25.0	25.0	25.0	25.0
Gear play	°	0.55 ... 1.1			0.55 ... 1.1			
Permissible operating temperature (T <sub>v</sub> )	°C	-20 ... +80			-20 ... +80			
Operating mode		S1			S1			
Protection class		IP 50			IP 50			
Weight	kg	0.9			1.3			
Shaft load radial / axial	N	150 / 500	250 / 500	400 / 500	550 / 500	800 / 500	1 100 / 500	1 300 / 500
Service life	h	5 000			5 000			
Lubrication		Maintenance-free grease lubrication for life						
Installation position		any						
Subject to alterations		on request						

Technical drawing

Image of 1-stage gearhead with left shaft end (W05) / All dimensions in mm

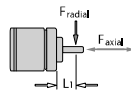
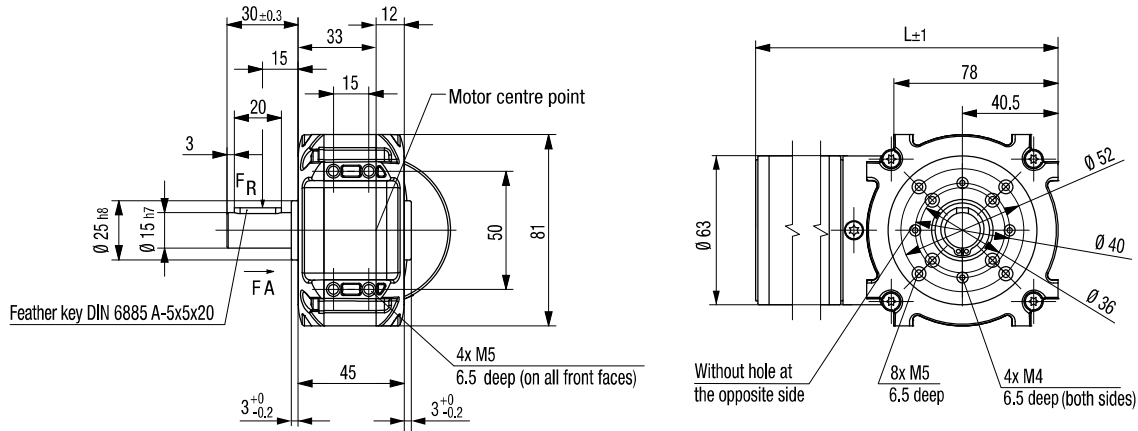

$F_{axial}$  500 N  
 $F_{radial}$  see table  
 $L1$  15 mm

Permissible shaft load at nominal speed and life expectancy  $L_{10}$  (nominal operation) and operating factor  $C_b = 1$  (see page 82) of 5 000 h (at  $T_u$  40°C).

Shaft end, right (W05) (standard)	Shaft end, left (W06)	Shaft end, both sides (W07)	Hollow shaft (W08)
			 Hollow shaft $\varnothing$ 10 mm

Length of the possible motor / gearhead combinations

Motor / gearhead		L - 1-stage	L - 2-stage
ECI-63.20-K1-E75	mm	197	233
ECI-63.40-K1-E75	mm	217	253
ECI-63.60-K1-E75	mm	237	273
ECI-63.20-K3-E75	mm	210	246
ECI-63.40-K3-E75	mm	230	266
ECI-63.60-K3-E75	mm	250	286
ECI-63.20-K4-E75	mm	210	246
ECI-63.40-K4-E75	mm	230	266
ECI-63.60-K4-E75	mm	250	286
ECI-63.20-K5-E75	mm	203	239
ECI-63.40-K5-E75	mm	223	259
ECI-63.60-K5-E75	mm	243	279

Subject to alterations