

ECI motor.

ECI-63.XX-K1



- Highly dynamic 3-phase internal rotor motor with EC technology
- Low cogging torque
- Robust, noise-optimized ball bearing system for a long service life
- High efficiency and high power density realized in a compact design
- Basic motor with electronic module K1 for operation with external control electronics
- Mechanical design and interfaces designed for modular flexibility
- Protection class IP 40 / IP 54 and connection by connector system

Nominal data							
Type		ECI-63.20-K1 -B00	ECI-63.20-K1 -D00	ECI-63.40-K1 -B00	ECI-63.40-K1 -D00	ECI-63.60-K1 -B00	ECI-63.60-K1 -D00
Nominal voltage (U_N)	V DC	24	48	24	48	24	48
Nominal speed (n_N)**	rpm	4 000					
Nominal torque (M_N)**	mNm	360	360	670	670	800	880
Nominal current (I_N)**	A	8.50	4.50	14.0	6.50	17.6	8.50
Nominal output power (P_N)**	W	150	150	280	280	335	370
Starting torque (M_{max})	mNm	1 800	1 800	3 300	3 300	5 300	4 400
Permissible peak current (I_{max})***	A	55	30	95	45	150	57
Speed at no-load operation (n_0)	rpm	5 800	6 800	5 900	5 900	6 100	6 000
No-load current (I_0)	A	0.50	0.30	0.70	0.32	1.30	0.45
Recommended speed control range	rpm	0 ... 5 000					
Rotor moment of inertia (J_R)	kgm ² x10 ⁻⁶	19	19	38	38	57	57
Motor constant (K_E)	mVs/rad	41.4	73.3	40.4	83.8	40.4	83.8
Connection resistance (R_N)	Ω	0.14	0.42	0.08	0.24	0.04	0.15
Connection inductance (L_N)	mH	0.26	0.88	0.14	0.57	0.09	0.33
Overload protection		To be implemented via the control electronics					
Permissible ambient temperature range (T_U)	°C	0 ... +40					
Weight	kg	0.90	0.90	1.20	1.20	1.50	1.50
Order no. (wire interface)*	IP 40	932 6320 103	932 6320 105	932 6340 103	932 6340 105	932 6360 106	932 6360 108
Order No. (connector interface)*	IP 54	932 6320 100	932 6320 102	932 6340 100	932 6340 102		932 6360 102
Subject to alterations		* Classification of protection class refers to installed state with sealing on the flange side The wave geometry for the IP54 version differs from the illustrated drawing ** At T_U max. 40°C *** Permissible time for peak current: max. 1 sec. – to be repeated only after complete cool down					

Characteristic curve

ECI-63.20-K1, 24 V (at 25°C)

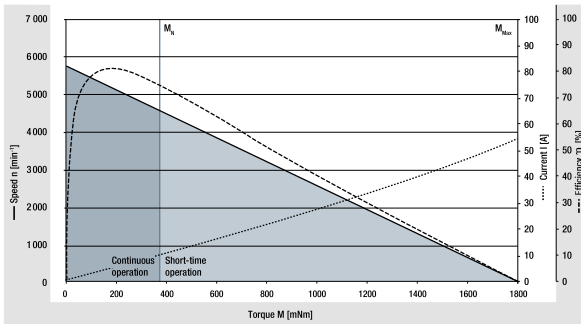

¹⁾ Nominal data, see table

Characteristic curve 48 V on request

ECI-63.40-K1, 24 V (at 25°C)

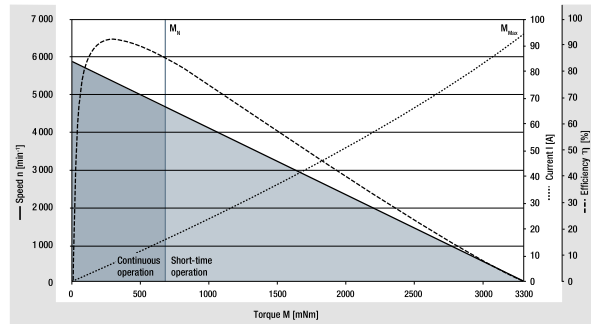

¹⁾ Nominal data, see table

Characteristic curve 48 V on request

ECI-63.60-K1, 24 V (at 25°C)

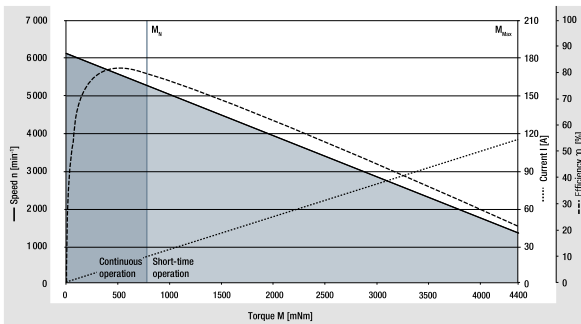

¹⁾ Nominal data, see table

Characteristic curve 48 V on request

ECI motor.

ECI-63.XX-K1

Technical drawing Strand design

All dimensions in mm

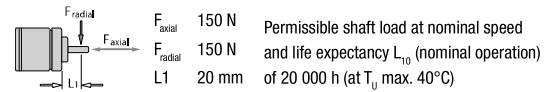
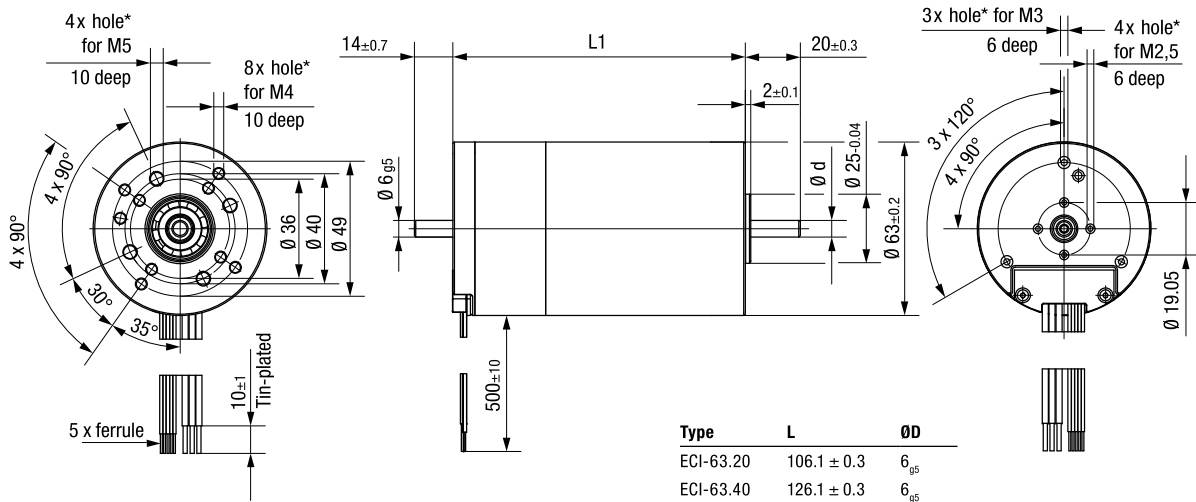

* For thread-rolling screws according to DIN 7500

Electrical connection

Supply wire		
Wire	Color	Function
1	yellow	Phase W
2	violet	Phase V
3	brown	Phase U

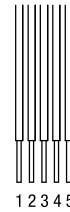

Signal wire		
Wire	Color	Function
4	green	Hall A
5	white	Hall B
6	gray	Hall C
7	red	U_B
8	black	GND

Planetary gearheads.

Performax®Plus 63



Image of 2-stage gearhead

- High torques thanks to large gearing width in the first gear stage
- Good shock resistance due to housing made of case-hardened steel with linear tooth profile in the output stage
- Very quiet running due to helical teeth in the first gear stage
- Planetary wheels made of plastic with optimized sliding properties in the first stage ensure smooth operation
- Large effective diameter thanks to radial screw connection

Nominal data												
Gearheads		Performax®Plus 63.1					Performax®Plus 63.2					
Reduction ratio		3.20	5.00	9.00	17.0	21.3	30.0	38.3	54.0	72.3	102	204
No. of stages		1					2					
Efficiency		0.90					0.81					
Max. input speed (n _i)	rpm	6 000					6 000					
Rated output torque (M _{ab})	Nm	6.50	11.9	7.60	4.40	45.2	64.0	28.9	41.0	16.9	23.9	27.4
Short-term torque (M _{max})	Nm	16.3	29.8	19.0	11.0	113	160	72.3	102.5	42.3	59.8	68.5
Gear play	°	0.7 ... 1.2					0.7 ... 1.2					
Permissible operating temperature (T _v)	°C	-20 ... +80					-20 ... +80					
Operating mode		S1					S1					
Protection class		IP 50					IP 50					
Weight	kg	0.66					1.20					
Shaft load radial / axial	N	350 / 500					350 / 500					
Service life	h	5 000					5 000					
Lubrication		Maintenance-free grease lubrication for life										
Installation position		any										
Subject to alterations		on request										

Technical drawing

Image of 1-stage gearhead / 2-stage design completely cylindrical / All dimensions in mm

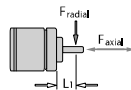
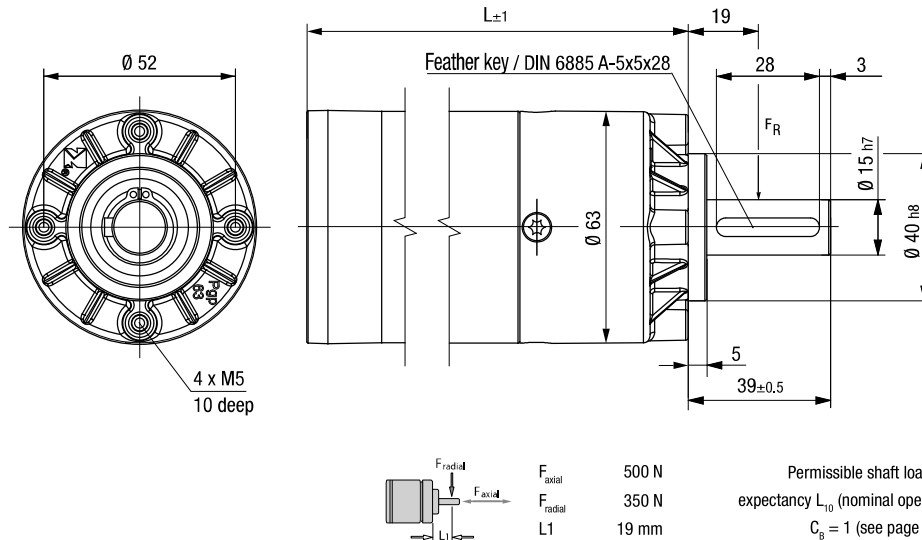

F_{axial} 500 N
 F_{radial} 350 N
 L_1 19 mm

Permissible shaft load at nominal speed and life expectancy L_{10} (nominal operation) and operating factor $C_b = 1$ (see page 82) of 5 000 h (at T_u 40°C).

Length of the possible motor / gearhead combinations

Motor / gearhead		L - 1-stage	L - 2-stage
ECI-63.20-K1-PP63	mm	164	185
ECI-63.40-K1-PP63	mm	184	205
ECI-63.60-K1-PP63	mm	204	225
ECI-63.20-K3-PP63	mm	176	198
ECI-63.40-K3-PP63	mm	196	218
ECI-63.60-K3-PP63	mm	216	238
ECI-63.20-K4-PP63	mm	176	198
ECI-63.40-K4-PP63	mm	196	218
ECI-63.60-K4-PP63	mm	216	238
ECI-63.20-K5-PP63	mm	170	191
ECI-63.40-K5-PP63	mm	190	211
ECI-63.60-K5-PP63	mm	210	231
ECI-80.20-K1-PP63	mm	154	175
ECI-80.40-K1-PP63	mm	174	195
ECI-80.60-K1-PP63	mm	194	215

Subject to alterations