

XAPM3504

die-cast empty control station - XAPM - Ø22 - zinc alloy - 4 horizontal openings



Main

Range of product	Harmony XAP
Product or component type	Die-cast empty control station
Device short name	XAPM
Product destination	For Ø 22 mm control and signalling units
Product front plate size	80 x 175 mm
Usable depth	74.5 mm
Number of cut-out	4 cut-outs
Colour of base of enclosure	Blue
Colour of cover	Blue
Material	Zinc alloy
Cable entry	1 hole with blanking plug for cable gland <= 18 mm 1 hole without blanking plug for cable gland <= 18 mm
Device mounting	Flush
IP degree of protection	IP65 conforming to IEC 60529 IP69K IP69 conforming to NF C 20-010

Complementary

Number of vertical rows	1
Product weight	1.14 kg

Environment

protective treatment	TC
ambient air temperature for storage	-40...70 °C
ambient air temperature for operation	-40...70 °C
overvoltage category	Class I conforming to NF C 20-030 Class I conforming to IEC 60536

Contractual warranty

Warranty period	18 months
-----------------	-----------

Dimensions and Fixing

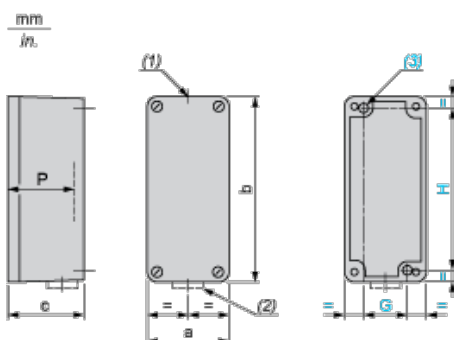

- (1) 1 hole, without blanking plug, for cable gland with 18 mm/0.71 in. maximum clamping capacity
- (2) 1 hole, with blanking plug (protrusion 6 mm/0.23 in.), for cable gland with 18 mm/0.71 in. maximum clamping capacity

(3) 2 x Ø 5.6 mm/0.22 in. holes, depth 20 mm/0.78 in.

P Usable depth

a		b		c		G		H		P	
mm	in.	mm	in.	mm	in.	mm	in.	mm	in.	mm	in.
80	3.15	175	6.89	77	3.03	50	1.97	160	6.30	74.5	2.93

Refer to the product characteristics to get the number of cut-outs.

Cut-out interaxis dimensions

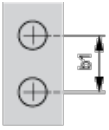

b1 Vertical interaxis: 30 mm/1.18 in.