

XACA08H7

empty pendant control station XAC-A - 8 vertical openings



Main

Range of product	Harmony XAC
Product or component type	Pendant control station
Device short name	XACA

Complementary

Control station type	Double insulated
Enclosure material	Polypropylene
Electrical circuit type	Control circuit
Enclosure type	Empty enclosure
Number of cut-out	8 cut-outs
Control station colour	Yellow
Cable entry	Rubber sleeve with stepped entry 8...26 mm
Guard rail	Without
Vertical operator cut-out centre	30 mm
Standards	EN/IEC 60204-32 EN/IEC 60947-5-1 UL 508 CSA C22.2 No 14
Product certifications	CCC CSA GOST UL
Protective treatment	TH
Ambient air temperature for operation	-25...70 °C
Ambient air temperature for storage	-40...70 °C
Vibration resistance	15 gn 10...500 Hz IEC 60068-2-6
Shock resistance	100 gn IEC 60068-2-27
Overvoltage category	Class II IEC 61140
IP degree of protection	IP65 IEC 60529
IK degree of protection	IK08 EN 50102
Mechanical durability	1000000 cycles
Product weight	0.77 kg

Environment

Contractual warranty

Warranty period	18 months
-----------------	-----------

Dimensions

Below drawing shows a product with 6 cut-outs. Select the number of cut-outs according to the product characteristics in order to get b,

b1 and c dimensions.

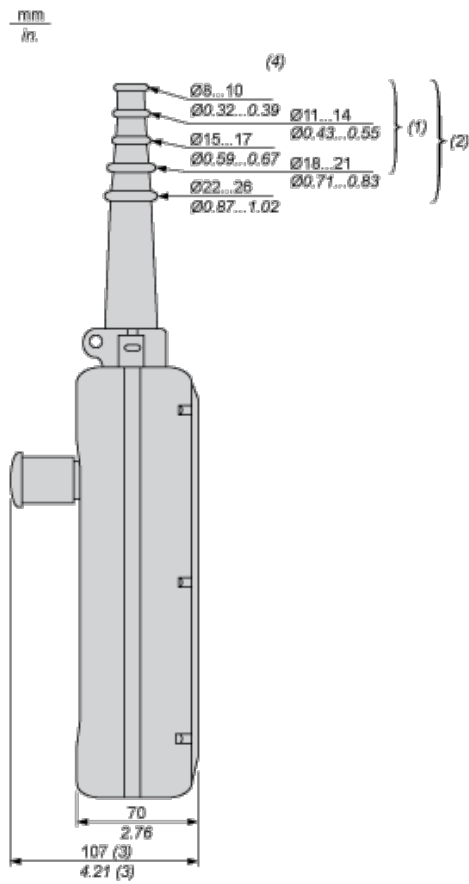

- (1) For 2 and 3-way XAC A stations.
- (2) For 4 to 8-way XAC A stations.
- (3) With trigger action Emergency stop head operator
- (4) Internal \varnothing

Dimensions in mm

Number of cut-outs	2	3	4	5	6	8	12
b	314	314	440	440	500	560	680
b1	190	190	250	250	310	370	490
c	80	80	80	80	80	80	92

Dimensions in in.

Number of cut-outs	2	3	4	5	6	8	12
b	12.36	12.36	17.32	17.32	19.68	22.05	26.77
b1	7.48	7.48	9.84	9.84	12.20	14.57	19.29
c	3.15	3.15	3.15	3.15	3.15	3.15	3.62