

## XACB08

empty pendant control station XAC-B - 8 vertical openings



### Main

Range of product	Harmony XAC
Product or component type	Pendant control station
Device short name	XACB

### Complementary

Control station type	Double insulated
Enclosure material	Glass reinforced polyester
Electrical circuit type	Control circuit Power circuit
Enclosure type	Empty enclosure
Number of cut-out	8 cut-outs
Control station colour	Yellow
Cable entry	Rubber sleeve with stepped entry 10...22 mm
Guard rail	Without
Vertical operator cut-out centre	40 mm
Standards	EN/IEC 60947-5-1 CSA C22.2 No 14
Product certifications	CSA type 4
Protective treatment	TH
Ambient air temperature for operation	-25...70 °C
Ambient air temperature for storage	-40...70 °C
Vibration resistance	15 gn 10...500 Hz IEC 60068-2-6
Shock resistance	100 gn IEC 60068-2-27
Overvoltage category	Class II IEC 61140
IP degree of protection	IP65 IEC 60529
IK degree of protection	IK08 EN 50102
Mechanical durability	1000000 cycles
Product weight	1.33 kg

### Environment

### Contractual warranty

Warranty period	18 months
-----------------	-----------

### Dimensions

Below drawing shows a product with 6 cut-outs. Select the number of cut-outs according to the product characteristics in order to get b, b1 and c dimensions.

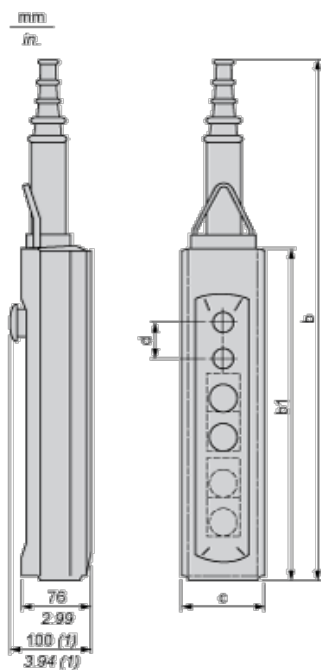

(1) With mushroom head operator

Dimensions in mm

Number of cut-outs	2	4	6	8	12
b	409	499	589	679	679
b1	220	310	400	490	490
c	98	98	98	98	98
d	40	40	40	40	30

Dimensions in in.

Number of cut-outs	2	4	6	8	12
b	16.10	19.64	23.19	26.73	26.73
b1	8.66	12.20	15.75	19.29	19.29
c	3.86	3.86	3.86	3.86	3.86
d	1.57	1.57	1.57	1.57	1.18

Protective cable sleeves

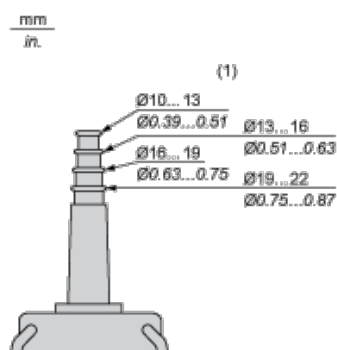

(1) Internal  $\varnothing$

## Control of Single-Speed Reversing Motor

With XESD1181 contact block, to be ordered separately



### Control of 2-Speed Reversing Motor

With XESD1281 contact block, to be ordered separately

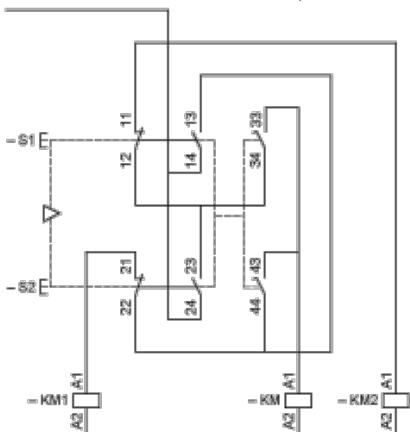

KM High speed contactor

### Control of Single-Speed Reversing Motor 2-Phase Switching

With XESD1191 contact block, to be ordered separately

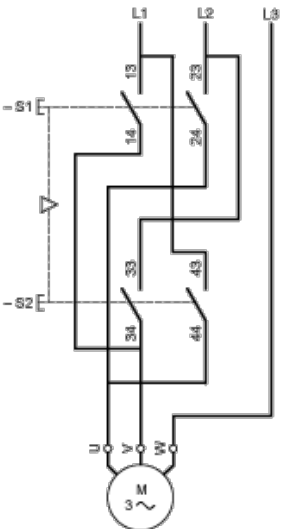

Combined with 3-pole isolating block XACS399 or XACS3991, shown in the unoperated position (pendant station "supplied"), fitted with key release trigger action latching Emergency stop operator.



### Control of 2-Speed Reversing Motor 2-Phase Switching

With XESD1291 contact block, to be ordered separately



### Control of Single-Speed Reversing Motor 3-Phase switching, Reversing by 2-Phase Inversion

With XESD2201 contact block, to be ordered separately



### Control of Single-Speed Reversing Motor 3-Phase switching, Reversing by 2-Phase Inversion

With XESD2241 contact block, to be ordered separately

