



### Main

Range of product	Harmony 9001SK
Product or component type	Selector switch
Device short name	9001SK
Type of operator	Stay put
Operator profile	Black long handle

### Complementary

Bezel material	Plastic
Mounting diameter	30 mm
Product weight	0.059 kg
Shape of signaling unit head	Octagonal
Operator position information	3 positions
Contacts type and composition	Without contact block
Mechanical durability	500000 cycles
Product compatibility	9001KA1, mounting on side 1 or 2
Device presentation	Basic element

### Environment

protective treatment	TC
ambient air temperature for storage	-40...70 °C
ambient air temperature for operation	-25...70 °C
electrical shock protection class	Class II conforming to IEC 61140
IP degree of protection	IP66 conforming to IEC 60529
NEMA degree of protection	NEMA 1 NEMA 12 NEMA 13 NEMA 2 NEMA 3 NEMA 3R NEMA 4 NEMA 4X NEMA 6
standards	EN/IEC 60947-1 EN/IEC 60947-5-1 EN/IEC 60947-5-4 JIS C 4520 JIS C 852 UL 508 CSA C22.2 No 14
product certifications	NEMA UL 508
vibration resistance	7 gn (f = 2...500 Hz) conforming to IEC 60068-2-6
shock resistance	50 gn conforming to IEC 60068-2-27

### Offer Sustainability

Sustainable offer status	785901849940
RoHS (date code: YYWW)	Compliant - since 0921 - Schneider Electric declaration of conformity
REACH	Reference not containing SVHC above the threshold

## Contractual warranty

Warranty period

18 months

## Dimensions

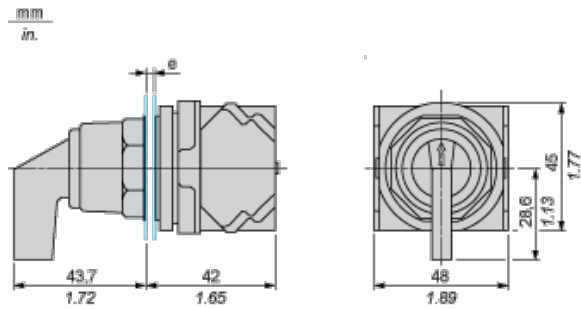

e panel thickness: 1 to 6 mm / 0.04 to 0.24 in.

## Contact Block Mounting Position

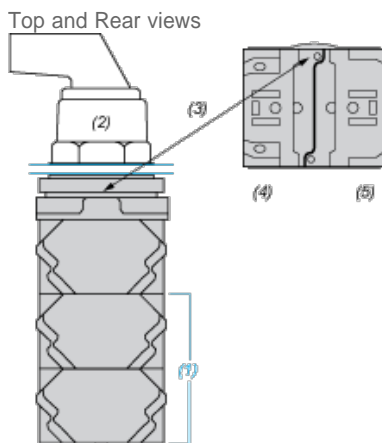

- (1) It is possible to mount up to 3 levels of contacts blocks (maximum of 6 contacts blocks)
- (2) Operator
- (3) Locating notch
- (4) Side 1
- (5) Side 2