

## K10F003MCH

cam ammeter switch - 3L-N - 90° - 10 A - for Ø 16 or 22 mm



### Main

Range of product	Harmony K
Product or component type	Complete cam switch
Component name	K10
[Ith] conventional free air thermal current	10 A
Product mounting	Front mounting
Fixing mode	Ø 16 or 22 mm hole
Cam switch head type	With front plate 30 x 30 mm
Type of operator	Black handle
Rotary handle padlocking	Without
Presentation of legend	With metallic legend, 0 - 1 - 2 - 3 black marking
Cam switch function	Ammeter switch
Return	Without
Type of measurement	For 3 circuits
Off position	With Off position
Switching positions	Right: 0° - 90° - 180° - 270°
IP degree of protection	IP20 (contact block) IP65 (operating head) conforming to IEC 60529

### Complementary

Switching angle	90 °
[Ui] rated insulation voltage	440 V degree of pollution 3 conforming to IEC 60947-1
Rated operational power in W	750 W AC-23A / 220/240 V 1 phase 370 W AC-23A / 110/120 V 1 phase 1800 W AC-23A / 220/240 V 3 phases
Rated power in hp	1 hp AC at 220/240 V 3 phases 0.33 hp AC at 110/120 V 1 phase 0.75 hp AC at 110/120 V 3 phases 0.75 hp AC at 220/240 V 1 phase
[Ie] rated operational current AC	10 A at 400 V AC-1 10 A at 400 V AC-21A 3 A at 240 V AC-15 6 A AC-15
[Ie] rated operational current DC	10 A at 24 V resistive load 0.3 A at 220 V resistive load 0.7 A at 110 V resistive load
Electrical durability	10000000 cycles
Short-circuit protection	10 A by cartridge fuse, type gG
[Uimp] rated impulse withstand voltage	4 kV conforming to IEC 60947-1
Contact operation	Slow-break
Electrical connection	Captive screw clamp terminals , 2 x 1.5 mm <sup>2</sup>
Mechanical durability	1000000 cycles
CAD overall width	30 mm
CAD overall height	30 mm
CAD overall depth	100 mm
Product weight	0.055 kg

### Environment

standards	CENELEC EN 50013 EN/IEC 60947-3 EN/IEC 60947-5-1
-----------	--

The information provided in this documentation contains general descriptions and/or technical characteristics of the products contained herein. This documentation is not intended as a substitute for and is not to be used for determining suitability or reliability of these products for specific user applications. It is the duty of any such user or integrator to perform the appropriate and complete risk analysis, evaluation and testing of the products with respect to the relevant specific application or use thereof. Neither Schneider Electric Industries SAS nor any of its affiliates or subsidiaries shall be responsible or liable for misuse of the information contained herein.

product certifications	CULus
protective treatment	TC
ambient air temperature for operation	-20...55 °C
ambient air temperature for storage	-40...70 °C
electrical shock protection class	Class II conforming to IEC 60536

### Contractual warranty

Warranty period	18 months
-----------------	-----------

### Cam Switch

Front Mounting by  $\varnothing 16$  mm/0.63 in. or  $\varnothing 22$  mm/0.87 in. hole

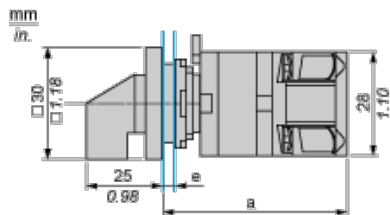

- a 75 mm/2.95 in.
- e support panel thickness: 0.5 mm to 5 mm/0.02 in. to 0.2 in.

### Cam Switch

$\varnothing 16$  mm/0.63 in. and  $\varnothing 22$  mm/0.87 in. Panel Cut-outs

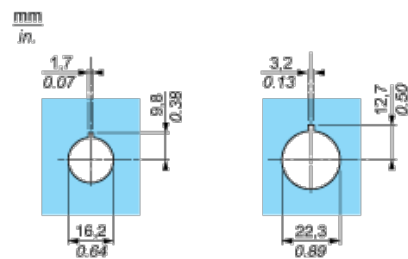

### Link Positions (Factory Mounted)

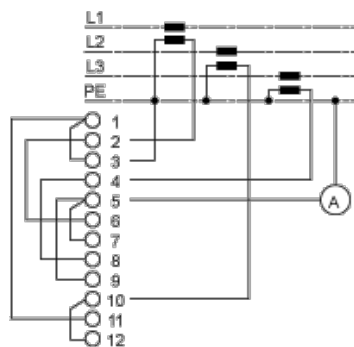

### Marking

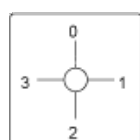



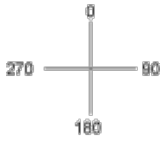

## Angular Position of Switch

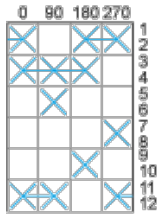

## Switching Program



## Convention Used for Switching Program Representation

-  Contact closed
-  Contact closed in 2 positions and maintained between the 2 positions
-  Sealed assembly for auto-maintain control
-  Overlapping contacts
-  Spring return position: for a switching angle of 90°, spring return is over 30° after the last position (for a maximum of 3 simultaneous contacts).

Example:

