



Main

Range of product	Harmony K
Product or component type	Complete cam switch
Component name	K30
[Ith] conventional free air thermal current	32 A
Product mounting	Front mounting
Fixing mode	4 holes
Cam switch head type	With front plate 64 x 64 mm
Type of operator	Black handle
Rotary handle padlocking	Without
Presentation of legend	With metallic legend, 0 - 1 black marking
Cam switch function	Switch
Return	Without
Off position	With Off position
Poles description	3P
Switching positions	Right: 0° - 60°
IP degree of protection	IP40 conforming to IEC 529 IP40 conforming to NF C 20-010

Complementary

Switching angle	60 °
[Ui] rated insulation voltage	690 V degree of pollution 3 conforming to EN 60947-1 690 V degree of pollution 3 conforming to IEC 60947-1
Short-circuit current	5000 A
Short-circuit protection	50 A by cartridge fuse, type gG
[Uimp] rated impulse withstand voltage	6 kV conforming to EN 947-1 6 kV conforming to IEC 947-1
Contact operation	Slow-break
Positive opening	With
Electrical connection	Captive screw clamp terminals flexible, 2 x 4 mm ² Captive screw clamp terminals solid, 2 x 6 mm ²
Tightening torque	1.2 N.m
Switching capacity in mA	11000 mA DC at 120 V 2 contact(s) for inductive load (T = 50 ms) 11000 mA DC at 180 V 3 contact(s) for inductive load (T = 50 ms) 11000 mA DC at 60 V 1 contact(s) for inductive load (T = 50 ms) 1200 mA DC at 220 V 1 contact(s) for resistive load (T = 1 ms) 1200 mA DC at 440 V 2 contact(s) for resistive load (T = 1 ms) 1200 mA DC at 660 V 3 contact(s) for resistive load (T = 1 ms) 16000 mA DC at 140 V 3 contact(s) for inductive load (T = 50 ms) 16000 mA DC at 48 V 1 contact(s) for inductive load (T = 50 ms) 16000 mA DC at 95 V 2 contact(s) for inductive load (T = 50 ms) 23000 mA DC at 120 V 2 contact(s) for resistive load (T = 1 ms) 23000 mA DC at 180 V 3 contact(s) for resistive load (T = 1 ms) 23000 mA DC at 60 V 1 contact(s) for resistive load (T = 1 ms) 25000 mA DC at 30 V 1 contact(s) for inductive load (T = 50 ms) 25000 mA DC at 60 V 2 contact(s) for inductive load (T = 50 ms) 25000 mA DC at 90 V 3 contact(s) for inductive load (T = 50 ms) 3200 mA DC at 110 V 1 contact(s) for inductive load (T = 50 ms) 3200 mA DC at 220 V 2 contact(s) for inductive load (T = 50 ms) 3200 mA DC at 330 V 3 contact(s) for inductive load (T = 50 ms) 32000 mA DC at 140 V 3 contact(s) for resistive load (T = 1 ms) 32000 mA DC at 24 V 1 contact(s) for inductive load (T = 50 ms) 32000 mA DC at 24 V 1 contact(s) for resistive load (T = 1 ms) 32000 mA DC at 48 V 1 contact(s) for resistive load (T = 1 ms) 32000 mA DC at 48 V 2 contact(s) for inductive load (T = 50 ms) 32000 mA DC at 48 V 2 contact(s) for resistive load (T = 1 ms) 32000 mA DC at 70 V 3 contact(s) for inductive load (T = 50 ms)

32000 mA DC at 70 V 3 contact(s) for resistive load (T = 1 ms)
 32000 mA DC at 95 V 2 contact(s) for resistive load (T = 1 ms)
 400 mA DC at 440 V 1 contact(s) for resistive load (T = 1 ms)
 400 mA DC at 660 V 2 contact(s) for resistive load (T = 1 ms)
 6500 mA DC at 110 V 1 contact(s) for resistive load (T = 1 ms)
 6500 mA DC at 220 V 2 contact(s) for resistive load (T = 1 ms)
 6500 mA DC at 330 V 3 contact(s) for resistive load (T = 1 ms)

Mechanical durability	300000 cycles
CAD overall width	64 mm
CAD overall height	64 mm
CAD overall depth	93 mm
Product weight	0.224 kg

Environment

standards	EN/IEC 60947-3
product certifications	CULus 120 V 2 hp 1 phase CULus 240 V 5 hp 1 phase CULus 240 V 5 hp 3 phases CULus 480 V 20 hp 3 phases
protective treatment	TC
ambient air temperature for operation	-25...55 °C
ambient air temperature for storage	-40...70 °C
electrical shock protection class	Class II conforming to NF C 20-030 Class II conforming to IEC 60536

Contractual warranty

Warranty period	18 months
-----------------	-----------

Dimensions

Rear Mounting

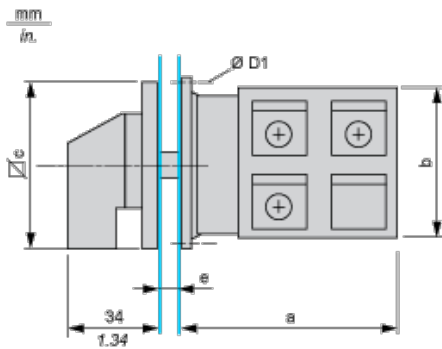

e support panel thickness 0.5 to 5.5 mm / 0.02 to 0.22 in in.

a		b		c		D1	
mm	in.	mm	in.	mm	in.	mm	in.
53.7	2.11	58	2.28	64	2.52	4.1	0.16

Panel Cut-Out

Front Mounting

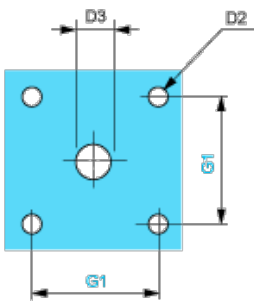

D2		D3		G1	
mm	in.	mm	in.	mm	in.
4.5	0.18	10	0.39	48	1.89

Link Positions (Factory Mounted)

Diagram for 1 to 6-pole Switches

Select the number of poles according to the product characteristics

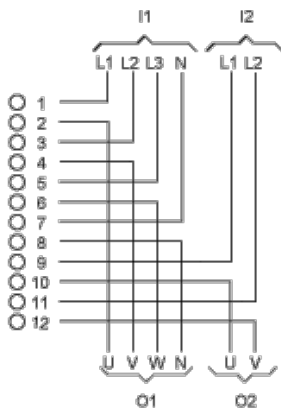

- I1 Input 1
- I2 Input 2
- O1 Output 1
- O2 Output 2

Marking

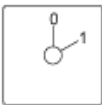

Angular Position of Switch



Switching Program



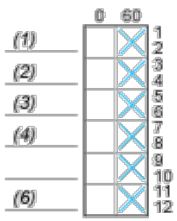

Diagram for 1 to 6-pole Switches

Select the number of poles according to the product characteristics



- (1) 1-pole
- (2) 2-pole
- (3) 3-pole
- (4) 4-pole
- (6) 6-pole

Convention Used for Switching Program Representation

-  Contact closed
-  Contact closed in 2 positions and maintained between the 2 positions
-  Sealed assembly for auto-maintain control
-  Overlapping contacts
-  Spring return position: for a switching angle of 90°, spring return is over 30° after the last position (for a maximum of 3 simultaneous contacts).

Example:

