

## Main

Range of product	Harmony K
Product or component type	Complete cam switch
Component name	K30
[Ith] conventional free air thermal current	32 A
Product mounting	Front mounting
Fixing mode	4 holes
Cam switch head type	With front plate 64 x 64 mm
Type of operator	Black handle
Rotary handle padlocking	Without
Presentation of legend	With metallic legend, OFF-ON black marking
Cam switch function	Switch
Return	Without
Off position	With Off position
Poles description	4P
Switching positions	Right: 0° - 90°
IP degree of protection	IP40 conforming to IEC 529 IP40 conforming to NF C 20-010

## Complementary

Switching angle	90 °
[Ui] rated insulation voltage	690 V degree of pollution 3 conforming to EN 60947-1 690 V degree of pollution 3 conforming to EN 60947-1 690 V degree of pollution 3 conforming to IEC 60947-1
Short-circuit current	5000 A
Short-circuit protection	50 A by cartridge fuse, type gG
[Uimp] rated impulse withstand voltage	6 kV conforming to EN 947-1 6 kV conforming to IEC 947-1
Contact operation	Slow-break
Positive opening	With
Electrical connection	Captive screw clamp terminals flexible, 2 x 4 mm <sup>2</sup> Captive screw clamp terminals flexible, 2 x 4 mm <sup>2</sup> Captive screw clamp terminals solid, 2 x 6 mm <sup>2</sup>
Tightening torque	1.2 N.m
Switching capacity in mA	11000 mA DC at 120 V 2 contact(s) for inductive load (T = 50 ms) 11000 mA DC at 180 V 3 contact(s) for inductive load (T = 50 ms) 11000 mA DC at 60 V 1 contact(s) for inductive load (T = 50 ms) 1200 mA DC at 220 V 1 contact(s) for resistive load (T = 1 ms) 1200 mA DC at 440 V 2 contact(s) for resistive load (T = 1 ms) 1200 mA DC at 660 V 3 contact(s) for resistive load (T = 1 ms) 16000 mA DC at 140 V 3 contact(s) for inductive load (T = 50 ms) 16000 mA DC at 48 V 1 contact(s) for inductive load (T = 50 ms) 16000 mA DC at 95 V 2 contact(s) for inductive load (T = 50 ms) 23000 mA DC at 120 V 2 contact(s) for resistive load (T = 1 ms) 23000 mA DC at 180 V 3 contact(s) for resistive load (T = 1 ms) 23000 mA DC at 60 V 1 contact(s) for resistive load (T = 1 ms) 25000 mA DC at 30 V 1 contact(s) for inductive load (T = 50 ms) 25000 mA DC at 60 V 2 contact(s) for inductive load (T = 50 ms) 25000 mA DC at 90 V 3 contact(s) for inductive load (T = 50 ms) 3200 mA DC at 110 V 1 contact(s) for inductive load (T = 50 ms) 3200 mA DC at 220 V 2 contact(s) for inductive load (T = 50 ms) 3200 mA DC at 330 V 3 contact(s) for inductive load (T = 50 ms) 32000 mA DC at 140 V 3 contact(s) for resistive load (T = 1 ms) 32000 mA DC at 24 V 1 contact(s) for inductive load (T = 50 ms) 32000 mA DC at 24 V 1 contact(s) for resistive load (T = 1 ms) 32000 mA DC at 48 V 1 contact(s) for resistive load (T = 1 ms) 32000 mA DC at 48 V 2 contact(s) for inductive load (T = 50 ms)

The information provided in this documentation contains general descriptions and/or technical characteristics of the products contained herein. This documentation is not intended as a substitute for and is not to be used for determining suitability or reliability of these products for specific user applications. It is the duty of any such user or integrator to perform the appropriate and complete risk analysis, evaluation and testing of the products with respect to the relevant specific application or use thereof. Neither Schneider Electric Industries SAS nor any of its affiliates or subsidiaries shall be responsible or liable for misuse of the information contained herein.

32000 mA DC at 48 V 2 contact(s) for resistive load (T = 1 ms)  
 32000 mA DC at 70 V 3 contact(s) for inductive load (T = 50 ms)  
 32000 mA DC at 70 V 3 contact(s) for resistive load (T = 1 ms)  
 32000 mA DC at 95 V 2 contact(s) for resistive load (T = 1 ms)  
 400 mA DC at 440 V 1 contact(s) for resistive load (T = 1 ms)  
 400 mA DC at 660 V 2 contact(s) for resistive load (T = 1 ms)  
 6500 mA DC at 110 V 1 contact(s) for resistive load (T = 1 ms)  
 6500 mA DC at 220 V 2 contact(s) for resistive load (T = 1 ms)  
 6500 mA DC at 330 V 3 contact(s) for resistive load (T = 1 ms)

Mechanical durability	300000 cycles
CAD overall width	64 mm
CAD overall height	64 mm
CAD overall depth	93 mm
Product weight	0.25 kg

## Environment

standards	EN/IEC 60947-3
product certifications	CULus 120 V 2 hp 1 phase CULus 240 V 5 hp 1 phase CULus 240 V 5 hp 3 phases CULus 480 V 20 hp 3 phases
protective treatment	TC
ambient air temperature for operation	-25...55 °C
ambient air temperature for storage	-40...70 °C
electrical shock protection class	Class II conforming to NF C 20-030 Class II conforming to IEC 60536 Class II conforming to IEC 60536

## Contractual warranty

Warranty period	18 months
-----------------	-----------

## Dimensions

### Rear Mounting

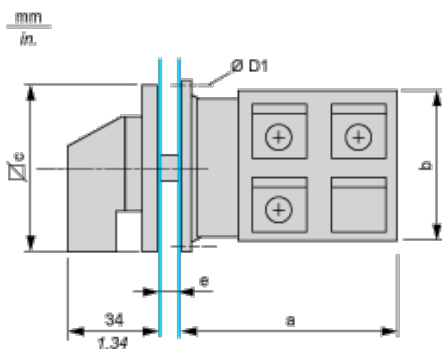

e support panel thickness 0.5 to 5.5 mm / 0.02 to 0.22 in. in.

a		b		c		D1	
mm	in.	mm	in.	mm	in.	mm	in.
53.7	2.11	58	2.28	64	2.52	4.1	0.16

## Panel Cut-Out

### Front Mounting

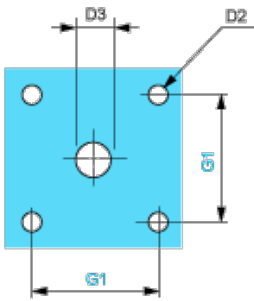

D2		D3		G1	
mm	in.	mm	in.	mm	in.
4.5	0.18	10	0.39	48	1.89

## Link Positions (Factory Mounted)

### Diagram for 3 to 4-pole Switches

Select the number of poles according to the product characteristics

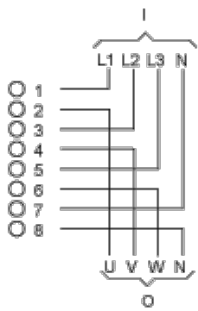

- I Input
- O Output

## Marking

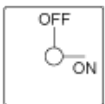

## Angular Position of Switch



## Switching Program



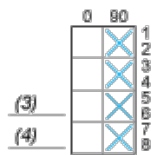

### Diagram for 3 to 4-pole Switches

Select the number of poles according to the product characteristics



- (3) 3-pole
- (4) 4-pole

## Convention Used for Switching Program Representation

-  Contact closed
-  Contact closed in 2 positions and maintained between the 2 positions
-  Sealed assembly for auto-maintain control
-  Overlapping contacts
-  Spring return position: for a switching angle of 90°, spring return is over 30° after the last position (for a maximum of 3 simultaneous contacts).

Example:

