

SSM1A120BD

solid state relay - DIN rail mount - input 4-32Vdc,
output 24-280Vac, 20A



Main

Range of product	Zelio Relay
Product or component type	Solid state relay
Device short name	SSM1
Network number of phases	1 phase

Complementary

Mounting support	Symmetrical DIN rail
[In] rated current	20 A
Output voltage	24...280 V AC
[Uc] control circuit voltage	4...32 V DC
Contacts type and composition	1 NO
Tightening torque	Input : 0.6...0.7 N.m Output : 1.36...1.7 N.m
Connections - terminals	Screw terminals : 1 x 0.2...1 x 5.3 mm ² , (AWG 24...AWG 10) for input Screw terminals : 1 x 0.2...1 x 5.3 mm ² , (AWG 24...AWG 10) for output
Capacitance unbalance	<= 8 pF for input/output
Insulation resistance	1000 MOhm at 500 V DC
Local signalling	LED green for input status
Switching voltage	4 V DC turn-on 1 V DC turn-off
Input current limits	8...12 mA
Solid state output type	Zero voltage switching SCR output
Load current	0.15...20 A
Absolute maximum voltage	600 V
Surge current	<= 250 A for 16.6 ms
Voltage drop	1.6 V on-state
Maximum I ² t for fusing	260 A ² .s for 8.3 ms
Leakage current	<= 10 mA off-state
DV/dt	500 V/μs off-state at maximum voltage
Response time	0.5 cycle turn-on 0.5 cycle turn-off
Overvoltage category	III
Product weight	0.28 kg

Environment

dielectric strength	4 kV AC for input/output 4 kV AC for input or output to case
pollution degree	2
standards	UL 508 IEC 60950-1 CSA C22.2 No 14
product certifications	CSA

The information provided in this documentation contains general descriptions and/or technical characteristics of the products contained herein. This documentation is not intended as a substitute for and is not to be used for determining suitability or reliability of these products for specific user applications. It is the duty of any such user or integrator to perform the appropriate and complete risk analysis, evaluation and testing of the products with respect to the relevant specific application or use thereof. Neither Schneider Electric Industries SAS nor any of its affiliates or subsidiaries shall be responsible or liable for misuse of the information contained herein.

	UL EAC
marking	CE CSA UL EAC
IP degree of protection	IP20
ambient air temperature for operation	-40...80 °C
ambient air temperature for storage	-40...125 °C

Offer Sustainability

Sustainable offer status	Green Premium product
RoHS (date code: YYWW)	Compliant - since 1522 - Schneider Electric declaration of conformity
REACH	Reference not containing SVHC above the threshold
Product environmental profile	Available
Product end of life instructions	Available

Dimensions

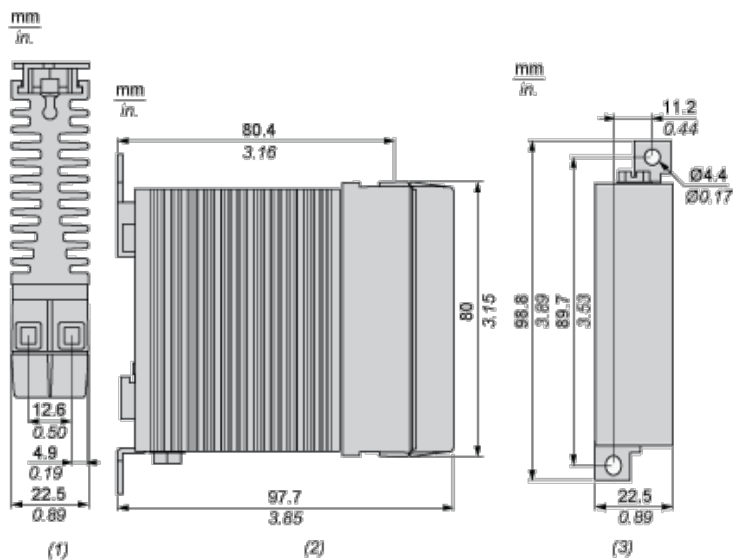

- (1) Top view
- (2) Side view
- (3) Front view

Derating Curves

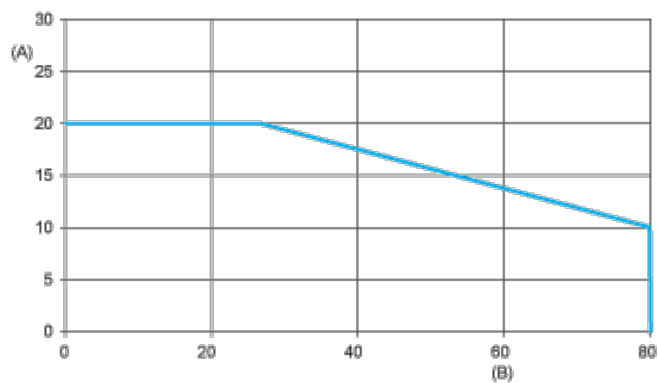

- A : Load Current (Amperes)
- B : Ambient Temperature (°C)