

ZB5FG06D

flush mounted selector switch head key 8D1 3 pos
return left to center



Main

Range of product	Harmony XB5
Product or component type	Head for key selector switch
Device short name	ZB5
Bezel material	Dark grey plastic
Mounting diameter	30 mm
Head type	Built-in-flush
Sale per indivisible quantity	1
Shape of signaling unit head	Round
Type of operator	Spring return left to centre
Operator profile	Black key switch
Operator position information	3 positions +/- 45°
Type of keylock	Dom 8D1
Key withdrawal position	Center

Complementary

CAD overall width	37 mm
CAD overall height	37 mm
CAD overall depth	72 mm
Product weight	0.069 kg
Mechanical durability	1000000 cycles
Electrical composition code	C11 for 3 contacts using single blocks in front mounting SF1 for 3 contacts using single blocks in front mounting C7 for 4 contacts using single blocks in front mounting C8 for 4 contacts using single and double blocks in front mounting C4 for 6 contacts using single and double blocks in front mounting C5 for 5 contacts using single blocks in front mounting C6 for 5 contacts using single and double blocks in front mounting C3 for 6 contacts using single blocks in front mounting
Customizable	No

Environment

protective treatment	TH
ambient air temperature for storage	-40...70 °C
ambient air temperature for operation	-40...70 °C
overvoltage category	Class II conforming to IEC 60536
IP degree of protection	IP67 IP66 conforming to IEC 60529 IP69K IP69
NEMA degree of protection	NEMA 13 NEMA 4X
resistance to high pressure washer	7000000 Pa at 55 °C, distance: 0.1 m
IK degree of protection	IK03 conforming to IEC 50102
standards	EN/IEC 60947-1 EN/IEC 60947-5-1 EN/IEC 60947-5-4 JIS C 4520 UL 508 CSA C22.2 No 14
product certifications	BV

The information provided in this documentation contains general descriptions and/or technical characteristics of the products contained herein. This documentation is not intended as a substitute for and is not to be used for determining suitability or reliability of these products for specific user applications. It is the duty of any such user or integrator to perform the appropriate and complete risk analysis, evaluation and testing of the products with respect to the relevant specific application or use thereof. Neither Schneider Electric Industries SAS nor any of its affiliates or subsidiaries shall be responsible or liable for misuse of the information contained herein.

CSA
 DNV
 GL
 LROS (Lloyds register of shipping)
 RINA
 UL listed

vibration resistance	5 gn (f = 2...500 Hz) conforming to IEC 60068-2-6
shock resistance	30 gn (duration = 18 ms) for half sine wave acceleration conforming to IEC 60068-2-27 50 gn (duration = 11 ms) for half sine wave acceleration conforming to IEC 60068-2-27

Offer Sustainability

Sustainable offer status	Green Premium product
RoHS (date code: YYWW)	Compliant - since 1804 - Schneider Electric declaration of conformity
REACH	Reference not containing SVHC above the threshold
Product environmental profile	Available
Product end of life instructions	Available

Dimensions

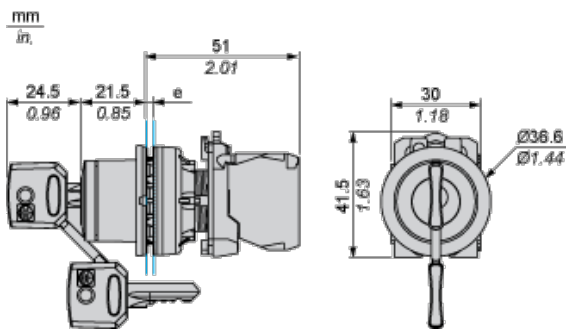

e: Clamping thickness: 1 to 6 mm / 0.04 to 0.24 in.

Panel Cut-out for Pushbuttons, Switches and Pilot Lights (Finished Holes, Ready for Installation)

Connection by Screw Clamp Terminals or Plug-in Connectors

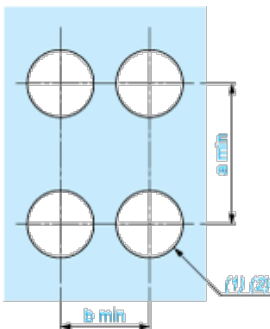

- (1) Diameter on finished panel or support
- (2) $\text{Ø}30.75 \text{ mm}$ recommended ($\text{Ø}30.5 \text{ }_0^{+0.5}$) / $\text{Ø}1.21 \text{ in.}$ recommended ($\text{Ø}1.20 \text{ in. }_0^{+0.0196}$)

Connections	a in mm	a in in.	b in mm	b in in.
By screw clamp terminals or plug-in connector	40	1.57	40	1.57
By Faston connectors	45	1.77	40	1.57

Electrical Composition Corresponding to Code C3



Electrical Composition Corresponding to Code C4



Electrical Composition Corresponding to Code C5

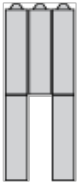

Electrical Composition Corresponding to Code C6



Electrical Composition Corresponding to Code C7

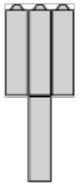

Electrical Composition Corresponding to Code C8

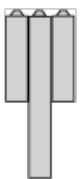

Electrical Composition Corresponding to Codes C9, C11, SF1 and SR1

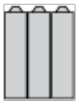

Electrical Composition Corresponding to Code C15

1 N/O

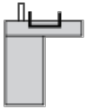

1 N/C

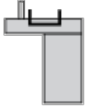

1 N/O + N/C or 1 N/O + N/O or 1 N/C + N/C

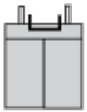

Legend

Single contact



Double contact



Light block



Possible location



Sequence of Contacts Fitted to 2-position Selector Switch Body

Position 315°



Push	Position	Top			
		Bottom			
	Location		Left	Centre	Right
	State		0	0	0
Contacts	N/O	open	open	open	

	N/C	closed	closed	closed
--	-----	--------	--------	--------

Position 45°



Push	Position	Top			
		Bottom			
	Location		Left	Centre	Right
	State		1	1	1
Contacts	N/O		closed	closed	closed
	N/C		open	open	open