

ZB6AD23

black selector switch head Ø16 3-position stay put



Main

Range of product	Harmony XB6
Product or component type	Head for selector switch
Device short name	ZB6
Bezel material	Plastic
Mounting diameter	16 mm
Sale per indivisible quantity	1
Shape of signaling unit head	Round
Type of operator	Stay put
Operator profile	Black standard handle
Operator position information	3 positions 60°

Complementary

CAD overall width	18 mm
CAD overall height	18 mm
CAD overall depth	43 mm
Product weight	0.018 kg

Environment

protective treatment	TC
ambient air temperature for storage	-40...70 °C
ambient air temperature for operation	-25...70 °C
electrical shock protection class	Class II conforming to IEC 61140
IP degree of protection	IP65 conforming to IEC 60529
NEMA degree of protection	NEMA 4 UL 50 NEMA 13 UL 50 NEMA 4X UL 50 NEMA 13 CSA C22.2 No 94 NEMA 4 CSA C22.2 No 94 NEMA 4X CSA C22.2 No 94
standards	EN/IEC 60947-1 EN/IEC 60947-5-1 EN/IEC 60947-5-5 JIS C 4520 JIS C 852 UL 508 CSA C22.2 No 14
product certifications	CCC CSA GOST UL
vibration resistance	+/- 3 mm (f = 2...500 Hz) conforming to IEC 60068-2-6 5 gn (f = 2...500 Hz) conforming to IEC 60068-2-6
shock resistance	30 gn (duration = 18 ms) for half sine wave acceleration conforming to IEC 60068-2-27 50 gn (duration = 11 ms) for half sine wave acceleration conforming to IEC 60068-2-27

Contractual warranty

Warranty period	18 months
-----------------	-----------

Circular Head for Selector Switch, Standard Handle

Dimensions

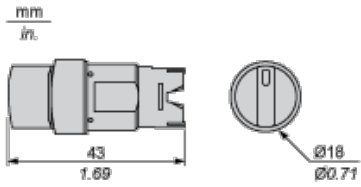

Panel Cut-out

For Square or Circular Head

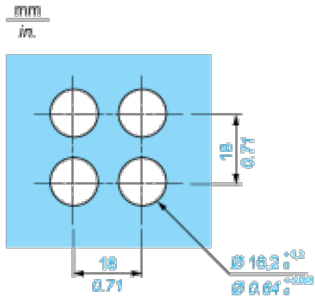

Pushbuttons, Switches and Pilot Lights for Printed Circuit Board Connection

Front Panel Cut-out (Viewed from Installer's Side)

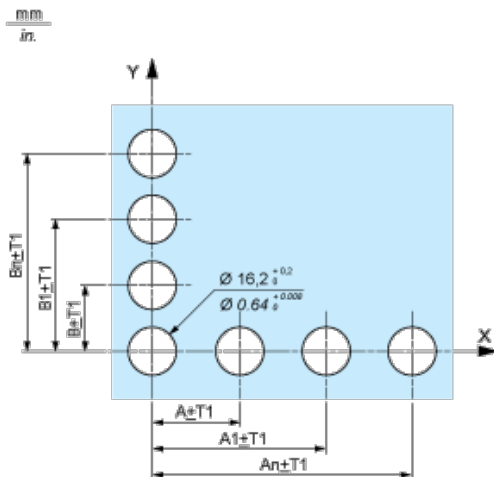

Printed Circuit Board Drillings (Viewed from Electrical Block Side)

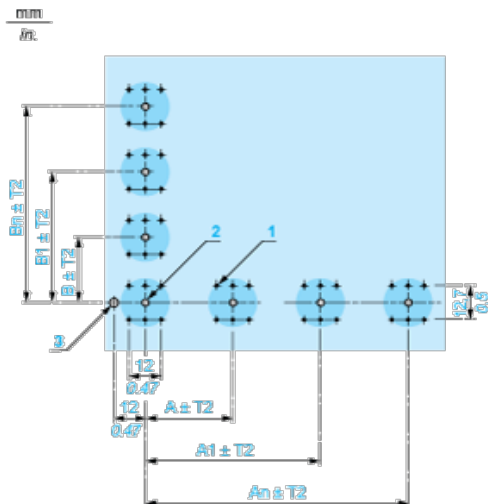

- A 24 mm/0.94 in. minimum for rectangular heads, 18 mm/0.71 in. minimum for square or circular heads
- B 18 mm/0.71 in. minimum

- (1) 6 x Ø 1.1 mm / 6 x Ø 0.04 in. holes.
- (2) 1 x Ø 2.6⁰_{-0.2} mm / 1 x Ø 0.10⁰_{-0.008} in. hole for locating pin, only when using socket adaptor ZB6Y010.
- (3) 1 x Ø 3.2⁰_{-0.2} mm / 1 x Ø 0.13⁰_{-0.008} in. hole for fixing of printed circuit board onto the front panel using body bracket ZB6Y011. This hole must be drilled on the left-hand side, when heads are positioned at the normal angle. Fit a body bracket ZB6Y011 every 72 mm/2.83 in. maximum for cut-outs on 24 mm/0.94 in. centres (rectangular heads) and 54 mm/2.13 in. maximum for cut-outs on 18 mm/0.71 in. centres (square or circular heads).

General tolerances of the panel and printed circuit board: T1, T2: T1 + T2 = 0.3 mm/0.01 in. maximum.

Installation precautions:

Thickness of printed circuit board: 1.6 mm/0.06 in. minimum.

Mounting with Body Bracket

With socket adaptor ZB6Y010

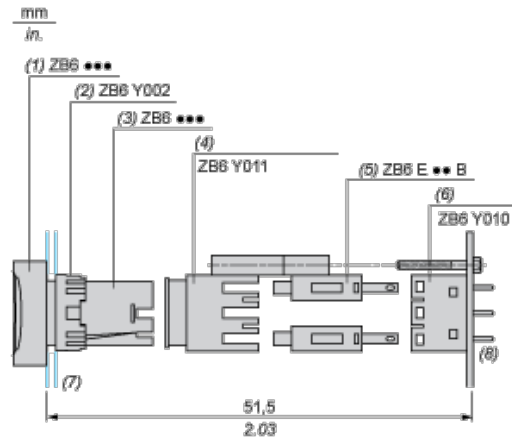

- (1) Head
- (2) Nut
- (3) Body
- (4) Body bracket
- (5) Contact block
- (6) Socket adaptor
- (7) Panel
- (8) Printed circuit

Direct mounting without socket adaptor ZB6Y010

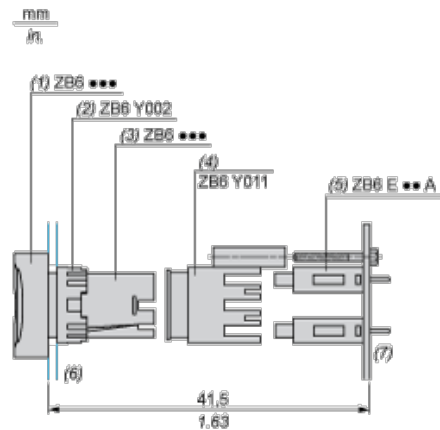

- (1) Head
- (2) Nut
- (3) Body
- (4) Body bracket
- (5) Contact block
- (6) Panel
- (7) Printed circuit