

XT130B1PAL2

capacitive sensor - XT1 - cylindrical M30 - brass - Sn
10 mm - cable 2 m



Main

Range of product	OsiSense XT
Sensor type	Capacitive proximity sensor
Product specific application	Detection of insulated or conductive materials
Sensor name	XT1
Sensor design	Cylindrical M30
Size	70 mm
Body type	Fixed
Detector flush mounting acceptance	Flush mountable
Material	Metal
Enclosure material	Nickel plated brass
Type of output signal	Discrete
Wiring technique	3-wire
[Sn] nominal sensing distance	10 mm
Discrete output function	1 NO
Output circuit type	DC
Discrete output type	PNP
Electrical connection	Cable
Cable length	2 m
[Us] rated supply voltage	24 V DC with reverse polarity protection
Delay response	<= 5 ms
IP degree of protection	IP67 conforming to IEC 60947-5-2 IP67 conforming to IEC 60529

Complementary

ISO thread	M30 x 1.5
Detection face	Frontal
[Sa] assured operating distance	0...7.2 mm
Adjustment zone	2...20 mm
Differential travel	< 0.2 x Sr
Repeat accuracy	< 0.1 x Sr
Wire insulation material	PVC
Status LED	1 LED (yellow) for output state indication
Supply voltage limits	12...30 V DC
Residual current	< 0.1 mA (open state)
Protection type	Short-circuit protection
Switching frequency	<= 150 Hz
Voltage drop	<= 2 V (closed)
Current consumption	< 15 mA
Delay first up	<= 30 ms
Delay recovery	<= 5 ms
Maximum switching current	200 mA
Marking	CE
Setting-up	Sensitivity by potentiometer
Threaded length	55 mm
Length	70 mm
Product weight	0.27 kg

Environment

standards	EN/IEC 60947-5-2
product certifications	CETLus
ambient air temperature for operation	-25...70 °C
vibration resistance	10 gn amplitude = 1 mm (10...55 Hz) conforming to IEC 60068-2-6
shock resistance	30 gn (duration = 11 ms) conforming to IEC 60068-2-27
resistance to electrostatic discharge	4 kV (contact) conforming to IEC 61000-4-2 8 kV (air) conforming to IEC 61000-4-2
resistance to electromagnetic fields	3 V/m conforming to IEC 61000-4-3
resistance to fast transients	2 kV conforming to IEC 61000-4-4

Offer Sustainability

Sustainable offer status	Not Green Premium product
RoHS (date code: YYWW)	Compliant - since 0727 - Schneider Electric declaration of conformity
REACH	Reference not containing SVHC above the threshold

Contractual warranty

Warranty period	18 months
-----------------	-----------

Dimensions

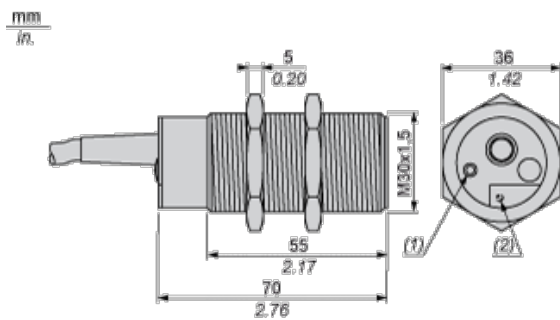

- (1) LED
- (2) Potentiometer beneath protective flap

Setting-up

Minimum Mounting Distances (mm)

Side by side

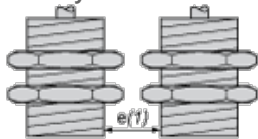

$$e(1) \geq 0$$

Face to face

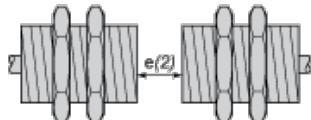

$$e(2) \geq 22$$

Facing a metal object

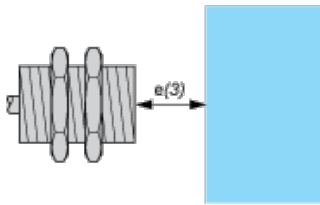

e(3) 20

≥

Mounted in support

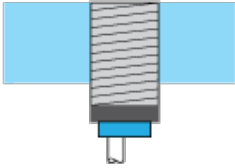

Fixing nut tightening torque: 40 N.m

Adjustment

Sensitivity Adjustment

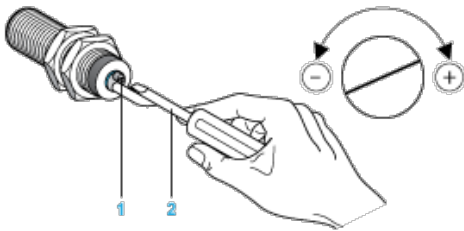

- (1) Adjustment potentiometer
- (2) Screwdriver (included with sensor)

Wiring Diagram

Pre-cabled

3-wire DC, PNP NO Output, Pre-cabled

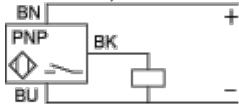

- (BU) Blue
- (BN) Brown
- (BK) Black