

XT218A1PAL2

capacitive sensor - XT1 - cylindrical M18 - plastic -
Sn 8 mm - cable 2m



Main

Range of product	OsiSense XT
Sensor type	Capacitive proximity sensor
Product specific application	Detection of insulated or conductive materials
Sensor name	XT2
Sensor design	Cylindrical M18
Size	78 mm
Body type	Fixed
Detector flush mounting acceptance	Non flush mountable
Material	Plastic
Enclosure material	Plastic
Type of output signal	Discrete
Wiring technique	3-wire
[Sn] nominal sensing distance	8 mm
Discrete output function	1 NO
Output circuit type	DC
Discrete output type	PNP
Electrical connection	Cable
Cable length	2 m
[Us] rated supply voltage	12...24 V DC with reverse polarity protection
Delay response	< 15 ms
IP degree of protection	IP67 double insulation conforming to IEC 60529

Complementary

ISO thread	M18 x 1
Detection face	Frontal
[Sa] assured operating distance	0...5.8 mm
Adjustment zone	0...12 mm
Differential travel	< 1...20 % Sr
Repeat accuracy	< 5 % Sr
Wire insulation material	PVC
Status LED	1 LED (yellow) for output state indication
Supply voltage limits	10...30 V DC
Residual current	<= 100 mA (open state)
Protection type	Short-circuit protection
Switching frequency	<= 200 Hz
Voltage drop	< 2.5 V (closed)
Current consumption	< 15 mA
Delay first up	< 100 ms
Delay recovery	< 15 ms
Maximum switching current	200 mA
Marking	CE
Setting-up	Sensitivity by potentiometer
Threaded length	47 mm
Length	78 mm
Product weight	0.15 kg

Environment

standards	EN/IEC 60947-5-2
product certifications	CULus
ambient air temperature for operation	-10...60 °C
vibration resistance	10 gn amplitude = 1 mm (10...55 Hz) conforming to IEC 60068-2-6
shock resistance	30 gn (duration = 11 ms) conforming to IEC 60068-2-27
resistance to electrostatic discharge	4 kV (contact) conforming to IEC 61000-4-2 8 kV (air) conforming to IEC 61000-4-2
resistance to electromagnetic fields	3 V/m conforming to IEC 61000-4-3
resistance to fast transients	2 kV conforming to IEC 61000-4-4

Offer Sustainability

Sustainable offer status	Not Green Premium product
RoHS (date code: YYWW)	Compliant - since 0918 - Schneider Electric declaration of conformity

Contractual warranty

Warranty period	18 months
-----------------	-----------

Dimensions

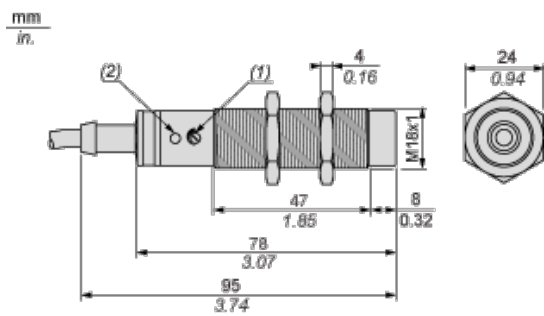

- (1) Adjustment potentiometer
- (2) LED

Setting-up

Minimum Mounting Distances (mm)

Side by side

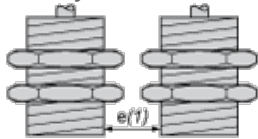

e(1) 40
≥

Face to face

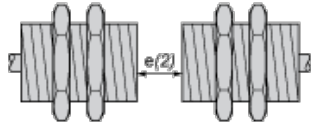

e(2) 48
≥

Facing a metal object

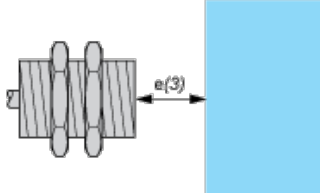

e(3) 24

≥

Mounted in support

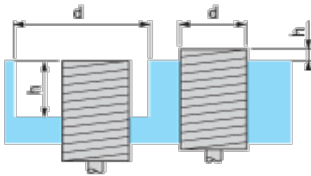

$d \geq 60$

$h \geq 20$

Fixing nut tightening torque: 3 N.m

Adjustment

Sensitivity Adjustment

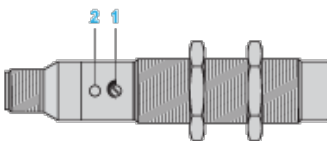

(1) Adjustment potentiometer

(2) LED

Wiring Diagram

Pre-cabled

3-wire DC, PNP NO Output

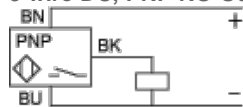

(BU) Blue

(BN) Brown

(BK) Black