

XS608B1NAL2

inductive sensor XS6 M8 - L51mm - stainless - Sn2.5mm - 12..48VDC - cable 2m



Main

Range of product	OsiSense XS
Series name	General purpose
Sensor type	Inductive proximity sensor
Device application	-
Sensor name	XS6
Sensor design	Cylindrical M8
Size	51 mm
Body type	Fixed
Detector flush mounting acceptance	Flush mountable
Material	Stainless steel
Type of output signal	Discrete
Wiring technique	3-wire
[Sn] nominal sensing distance	2.5 mm
Discrete output function	1 NO
Output circuit type	DC
Discrete output type	NPN
Electrical connection	Cable
Cable length	2 m
[Us] rated supply voltage	12...48 V DC with reverse polarity protection
Switching capacity in mA	<= 200 mA DC with overload and short-circuit protection
IP degree of protection	IP67 conforming to IEC 60529

Complementary

Thread type	M8 x 1
Detection face	Frontal
Front material	PPS
Enclosure material	Stainless steel 303
Operating zone	0...2 mm
Differential travel	1...15% of Sr
Cable composition	3 x 0.11 mm ²
Wire insulation material	PvR
Status LED	1 LED (yellow) for output state
Supply voltage limits	10...58 V DC
Switching frequency	<= 2500 Hz
Voltage drop	<= 2 V, closed state
Current consumption	<= 10 mA (no-load)
Delay first up	<= 10 ms
Delay response	<= 0.2 ms
Delay recovery	<= 0.2 ms
Marking	CE
Threaded length	42 mm
Length	51 mm
Product weight	0.035 kg

The information provided in this documentation contains general descriptions and/or technical characteristics of the products contained herein. This documentation is not intended as a substitute for and is not to be used for determining suitability or reliability of these products for specific user applications. It is the duty of any such user or integrator to perform the appropriate and complete risk analysis, evaluation and testing of the products with respect to the relevant specific application or use thereof. Neither Schneider Electric Industries SAS nor any of its affiliates or subsidiaries shall be responsible or liable for misuse of the information contained herein.

Environment

product certifications	CSA UL
ambient air temperature for operation	-25...70 °C
ambient air temperature for storage	-40...85 °C
vibration resistance	25 gn, amplitude: +/- 2 mm (f = 10...55 Hz) conforming to IEC 60068-2-6
shock resistance	50 gn (duration = 11 ms) conforming to IEC 60068-2-27

Offer Sustainability

Sustainable offer status	Green Premium product
RoHS (date code: YYWW)	Compliant - since 0953 - Schneider Electric declaration of conformity
REACH	Reference not containing SVHC above the threshold
Product environmental profile	Available
Product end of life instructions	Available

Contractual warranty

Warranty period	18 months
-----------------	-----------

Dimensions

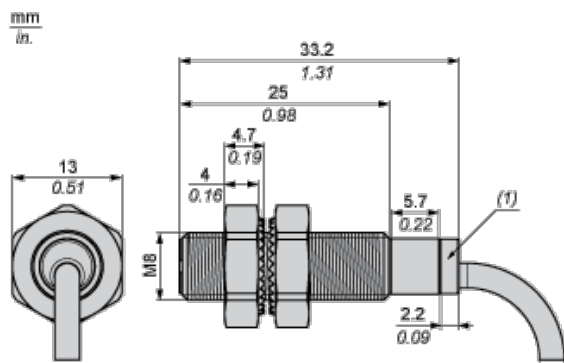

(1) LED

Minimum Mounting Distances in mm

Side by side

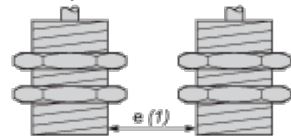

e (1) 5 mm/0.20 in.

≥

Face to face

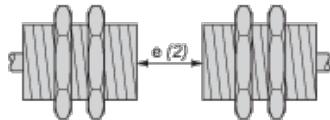

e (2) 30 mm/1.18 in.

≥

Facing a metal object

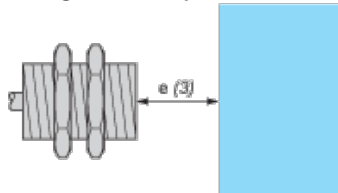

e (3) 8 mm/0.31 in.
≥

Mounting

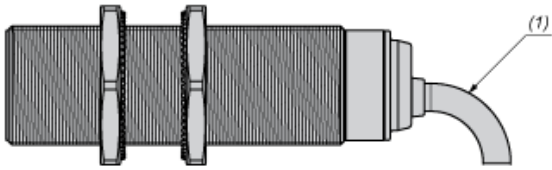

(1) Bending cable: 4 x external cable diameter

Wiring Schemes

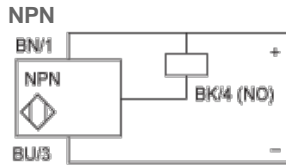

BU : Blue
BN : Brown
BK : Black

Performance Curves

Standard Steel Target (mm) : 8x8x1

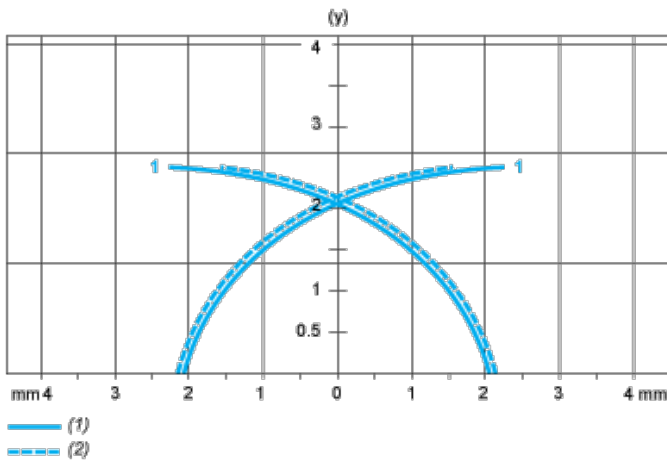

- (1) Pick-up points
(2) Drop-out points (object approaching from the side)
(y) Sensing distance in mm