

FEATURES

- Patents pending
- Lower Profile
- UL60950 recognised⁴
- ANSI/AAMI ES60601-1, 2 MOOP, 1MOPP recognised⁵
- 5.2KVDC Isolation 'Hi Pot Test'
- Substrate Embedded Transformer
- Automated Manufacture
- Short Circuit Protection³
- Halogen Free

PRODUCT OVERVIEW

The NXJ2 series is a new range of lower profile, fully automated manufacture surface mount DC-DC converters. The NXJ2 series automated manufacturing process with substrate Embedded Transformer, offers increased product reliability and repeatability of performance in a halogen free, iLGA inspectable package. The NXJ2 series, industry standard footprint is compatible with existing designs.

The NXJ2 series has a MSL rating 2, and is compatible with a peak reflow solder temperature of 260°C as per J-STD-020.

SELECTION GUIDE

| Order Code ¹ | Nominal Input Voltage | Output Voltage | Rated Input Current | Output Current | Load Regulation (Typ) | Load Regulation (Max) | Output Ripple & Noise (Typ) | Output Ripple & Noise (Max) | Efficiency (Min) | Efficiency (Typ) | Switching Frequency (Typ) | Isolation Capacitance | MTTF ² | |
|-------------------------|-----------------------|----------------|---------------------|----------------|-----------------------|-----------------------|-----------------------------|-----------------------------|------------------|------------------|---------------------------|-----------------------|-------------------|------------|
| | V | V | mA | mA | % | % | mVp-p | mVp-p | % | % | kHz | pF | MIL 217 | Telecordia |
| | | | | | | | | | | | | | kHrs | kHrs |
| NXJ2S0505MC | 5 | 5 | 550 | 400 | 7.5 | 10 | 50 | 110 | 68.5 | 72.5 | 140 | 2 | 2874 | 40967 |
| NXJ2S1212MC | 12 | 12 | 215 | 167 | 7 | 9 | 30 | 70 | 72 | 75 | 120 | 2 | 1766 | 65080 |
| NXJ2S1215MC | 12 | 15 | 215 | 133 | 8 | 10 | 25 | 60 | 75 | 77.5 | 110 | 2.2 | 1334 | 49049 |
| NXJ2S2405MC | 24 | 5 | 110 | 400 | 8 | 10 | 70 | 170 | 73 | 76.5 | 100 | 2.4 | 2026 | 33111 |
| NXJ2S2415MC | 24 | 15 | 105 | 133 | 6.5 | 8 | 20 | 50 | 74.5 | 78.5 | 95 | 2.4 | 1232 | 44260 |

INPUT CHARACTERISTICS

| Parameter | Conditions | Min. | Typ. | Max. | Units |
|--------------------------------|---------------------------------------|------|------|------|--------|
| Voltage range | Continuous operation, 5V input types | 4.5 | 5.0 | 5.5 | V |
| | Continuous operation, 12V input types | 10.8 | 12 | 13.2 | |
| | Continuous operation, 24V input types | 21.6 | 24 | 26.4 | |
| Input reflected ripple current | 5V input | | 15 | | mA p-p |
| | 12V & 24V input | | 5 | | |

ISOLATION CHARACTERISTICS

| Parameter | Conditions | Min. | Typ. | Max. | Units |
|-------------------|-----------------------------------|------|------|------|-------|
| Isolation voltage | Production tested for 1 second | 5200 | | | VDC |
| | Qualification tested for 1 minute | 5200 | | | |
| Resistance | Viso= 1000VDC | 10 | | | GΩ |

OUTPUT CHARACTERISTICS

| Parameter | Conditions | Min. | Typ. | Max. | Units |
|----------------------------|---|-----------------------|------|------|-------|
| Rated power | T _A =-40°C to 85°C | | | 2.0 | W |
| Voltage set point accuracy | See tolerance envelope | | | | |
| Line regulation | High V _{IN} to low V _{IN} | 24V input types | | 1 | %/% |
| | | All other input types | | 1.1 | |

TEMPERATURE CHARACTERISTICS

| Parameter | Conditions | Min. | Typ. | Max. | Units |
|--|---------------------|------|------|------|-------|
| Specification | All output types | -40 | | 85 | °C |
| Storage | | -50 | | 125 | |
| Product temperature rise above ambient | 5V input types | | 35 | | |
| | 12V input types | | 30 | | |
| | 24V input types | | 25 | | |
| Cooling | Free air convection | | | | |

ABSOLUTE MAXIMUM RATINGS

| | |
|---|-----|
| Input voltage V _{IN} , NXJ2S05 types | 7V |
| Input voltage V _{IN} , NXJ2S12 types | 15V |
| Input voltage V _{IN} , NXJ2S24 types | 28V |

- Components are supplied in tape and reel packaging, please refer to package specification section. Orderable part numbers are NXJ2SXXXXMC-R7 (135 pieces per reel), or NXJ2SXXXXMC-R13 (600 pieces per reel).
- Calculated using MIL-HDBK-217 FN2 and Telecordia SR-332 calculation model at T_A=25°C with nominal input voltage at full load.
- Please refer to short circuit application notes.
- UL60950 recognition is currently pending for NXJ2S2405MC and NXJ2S2415MC.
- ANSI/AAMI ES60601-1 recognition is currently pending for NXJ2S2405MC and NXJ2S2415MC.

All specifications typical at T_A=25°C, nominal input voltage and rated output current unless otherwise specified.



For full details go to www.murata-ps.com/rohs

TECHNICAL NOTES

ISOLATION VOLTAGE

'Hi Pot Test', 'Flash Tested', 'Withstand Voltage', 'Proof Voltage', 'Dielectric Withstand Voltage' & 'Isolation Test Voltage' are all terms that relate to the same thing, a test voltage, applied for a specified time, across a component designed to provide electrical isolation, to verify the integrity of that isolation.

Murata Power Solutions NXJ2 series of DC-DC converters are all 100% production tested at 5.2kVDC for 1 second and have been qualification tested at 5.2kVDC for 1 minute.

A question commonly asked is, "What is the continuous voltage that can be applied across the part in normal operation?"

The NXJ2 series is recognised by Underwriters Laboratory, please see safety approval section for more information. When the insulation in the NXJ2 is not used as a safety barrier, i.e. provides functional isolation only, continuous or switched voltages across the barrier in excess of 1kV are sustainable. Long term reliability testing at these voltages continues. Please contact Murata for further information.

REPEATED HIGH-VOLTAGE ISOLATION TESTING

It is well known that repeated high-voltage isolation testing of a barrier component can actually degrade isolation capability, to a lesser or greater degree depending on materials, construction and environment. The NXJ2 series has a PCB embedded isolated transformer, using FR4 as an insulation barrier between primary and secondary windings. While parts can be expected to withstand several times the stated test voltage, the isolation capability does depend on the FR4 insulation properties. Any material, including FR4 is susceptible to eventual chemical degradation when subject to very high applied voltages thus implying that the number of tests should be strictly limited. We therefore strongly advise against repeated high voltage isolation testing, but if it is absolutely required, that the voltage should be reduced by 20% from specified test voltage.

This consideration equally applies to agency recognized parts rated for better than functional isolation where the insulation is always supplemented by a further insulation system of physical spacing or barriers.

SAFETY APPROVAL

ANSI/AAMI ES60601-1

The NXJ2 series is recognised by Underwriters Laboratory (UL) to ANSI/AAMI ES60601-1 and provides 1 MOPP (Means Of Patient Protection) and 2 MOOP (Means Of Operator Protection) based upon a working voltage of 250 Vrms max, between input and output. The NXJ2S2405MC and NXJ2S2415MC are currently pending recognition.

UL 60950

The NXJ2 series is recognised by Underwriters Laboratory (UL) to UL 60950 for reinforced insulation to a working voltage of 250Vrms. The NXJ2S2405MC and NXJ2S2415MC are currently pending recognition.

FUSING

The NXJ2 Series of converters are not internally fused so to meet the requirements of UL an anti-surge input line fuse should always be used with ratings as defined below.

Input Voltage, 5V: 1A

Input Voltage, 12V: 500mA

Input Voltage, 24V: 250mA

All fuses should be UL recognized and rated to at least the maximum allowable DC input voltage.

RoHS COMPLIANCE AND MSL INFORMATION



This series is compatible with Pb-Free soldering systems and is also backward compatible with Sn/Pb soldering systems.

The NXJ2 series can be soldered in accordance with J-STD-020 and have a classification temperature of 260°C and moisture sensitivity level 2. The termination finish on this product is Gold with plating thickness 0.12 microns.

APPLICATION NOTES

Short Circuit Performance

The NXJ2 series short circuit performance is currently being evaluated. Please contact Murata for further information.

Advisory Notes

The NXJ2 series is not hermetically sealed, customers should ensure that parts are fully dried before input power application.

Minimum Load

The minimum load to meet datasheet specification is 10% of the full rated load across the specified input voltage range. Lower than 10% minimum loading will result in an increase in output voltage, which may rise to typically double the specified output voltage if the output load falls to less than 5%.

Capacitive Loading & Start Up

Typical start up times for this series, with a typical input voltage rise time of 2.2µs with resistive only load, and with added output capacitance of 10µF, are shown in the table below.

| Part Number | Start-Up Time | |
|-------------|---------------|--|
| | µS | |
| NXJ2S0505MC | 260 | |
| NXJ2S1212MC | 840 | |
| NXJ2S1215MC | 1200 | |
| NXJ2S2405MC | 160 | |
| NXJ2S2415MC | 1110 | |

Typical Start-Up Wave Form

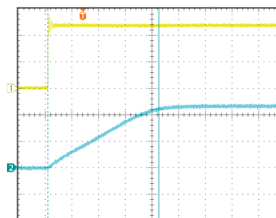

Output Ripple Reduction

By using the values of inductance and capacitance stated, the output ripple at the rated load is lowered to 5mV p-p max.

Component selection

Capacitor: It is required that the ESR (Equivalent Series Resistance) should be as low as possible, ceramic types are recommended. The voltage rating should be at least twice (except for 15V output), the rated output voltage of the DC-DC converter.

Inductor: The rated current of the inductor should not be less than that of the output of the DC-DC converter. At the rated current, the DC resistance of the inductor should be such that the voltage drop across the inductor is <2% of the rated voltage of the DC-DC converter. The SRF (Self Resonant Frequency) should be >20MHz.

| | Inductor | | | Capacitor |
|-------------|----------|--------|--------------|-----------|
| | L, µH | SMD | Through Hole | C, µF |
| NXJ2S0505MC | 4.7 | 82472C | 11R472C | 10 |
| NXJ2S1212MC | 4.7 | 82472C | 11R472C | 4.7 |
| NXJ2S1215MC | 4.7 | 82472C | 11R472C | 4.7 |
| NXJ2S2405MC | 4.7 | 82472C | 11R472C | 10 |
| NXJ2S2415MC | 4.7 | 82472C | 11R472C | 4.7 |

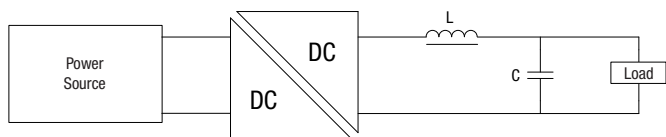

TOLERANCE ENVELOPES

The voltage tolerance envelope shows typical load regulation characteristics for this product series. The tolerance envelope is the maximum output voltage variation due to changes in output loading.

NXJ2S0505MC

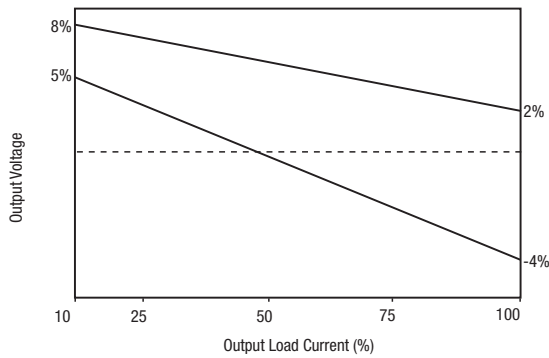

NXJ2S1212MC

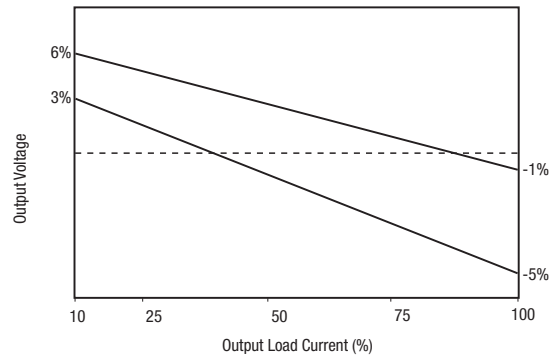

NXJ2S1215MC

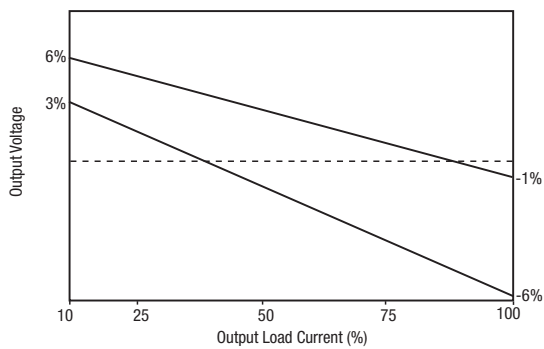

NXJ2S2405MC

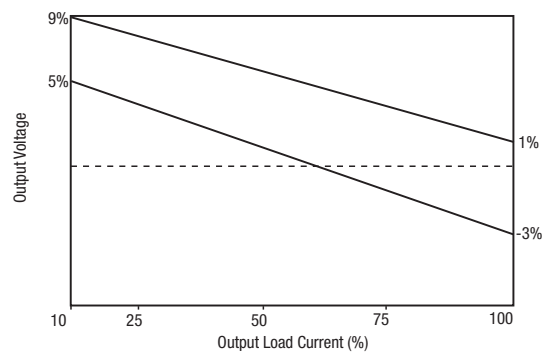

NXJ2S2415MC

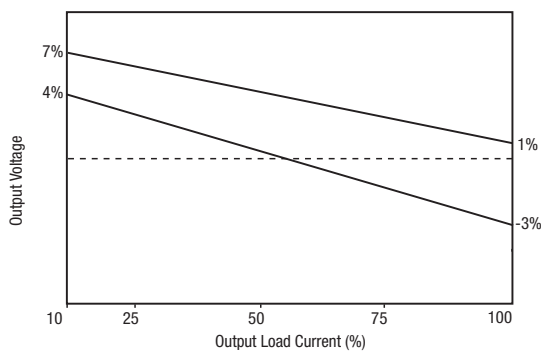

EFFICIENCY VS LOAD

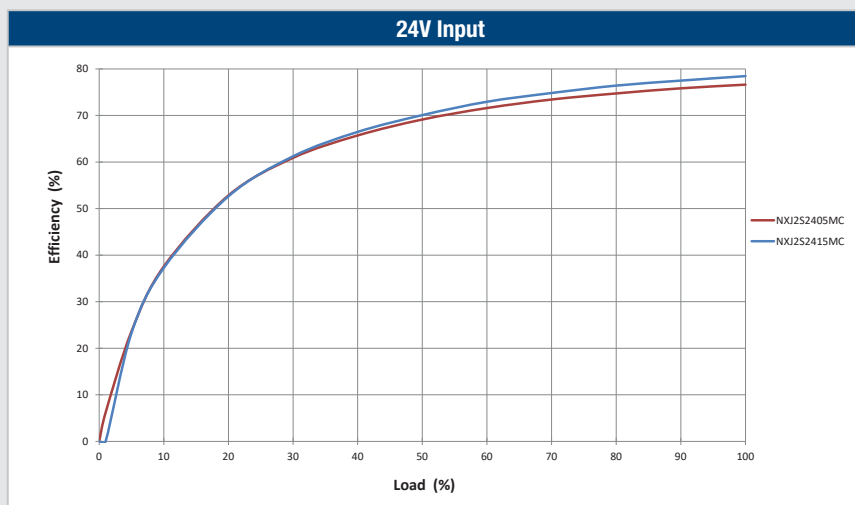
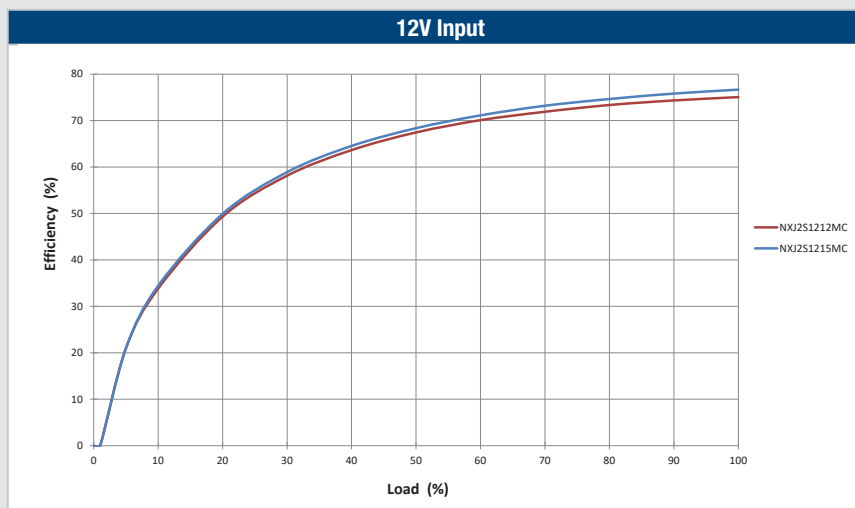
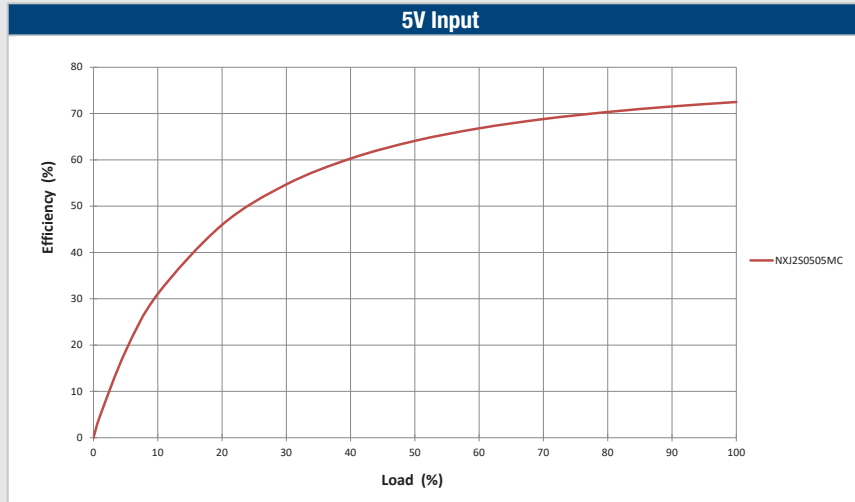

TEMPERATURE DERATING

NXJ2S0505MC

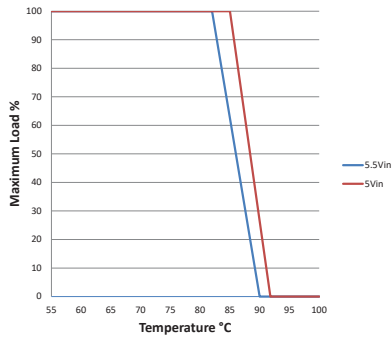

NXJ2S1212MC

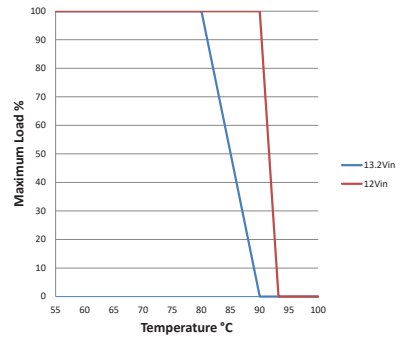

NXJ2S1215MC

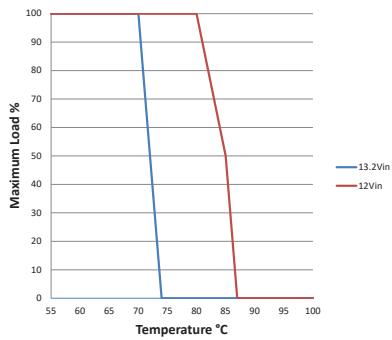

NXJ2S2405MC

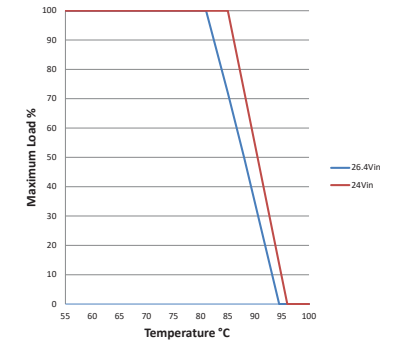

NXJ2S2415MC

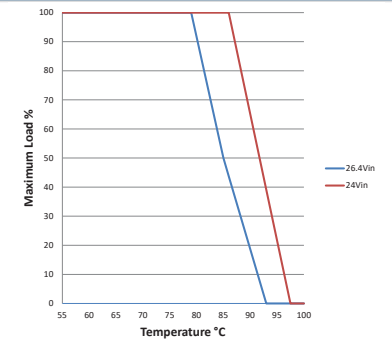

EMC FILTERING AND SPECTRA

FILTERING

The following table shows the additional input capacitor and input inductor typically required to meet EN 55022 Curve A & B CISPR22 Average Limit as shown in the following plots. The following plots show positive and negative average limit and CISPR22 Average Limit A (pink line) and CISPR22 Average Limit B (green line) adherence limits. The below values are for guidance only and should be evaluated in the application circuit.

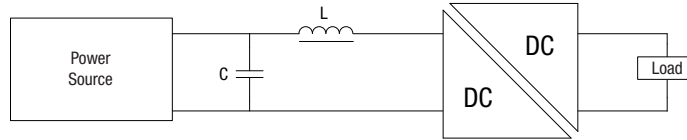

| | Inductor | | | Capacitor | |
|-------------|------------|--------|--------------|------------|-------------------|
| | L, μ H | SMD | Through Hole | C, μ F | SMD |
| NXJ2S0505MC | 10 | 84103C | 11R103C | 15 | GRM55ER71E156KA01 |
| NXJ2S1212MC | 10 | 82103C | 11R103C | 15 | GRM55ER71E156KA01 |
| NXJ2S1215MC | 10 | 82103C | 11R103C | 15 | GRM55ER71E156KA01 |
| NXJ2S2405MC | 10 | 82103C | 11R103C | 15 | KRM55LR7YA156KH01 |
| NXJ2S2415MC | 10 | 82103C | 11R103C | 15 | KRM55LR7YA156KH01 |

NXJ2S0505MC (Quasi Peak)

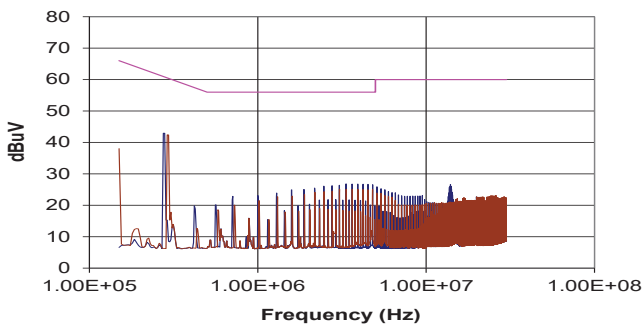

NXJ2S0505MC (Average)

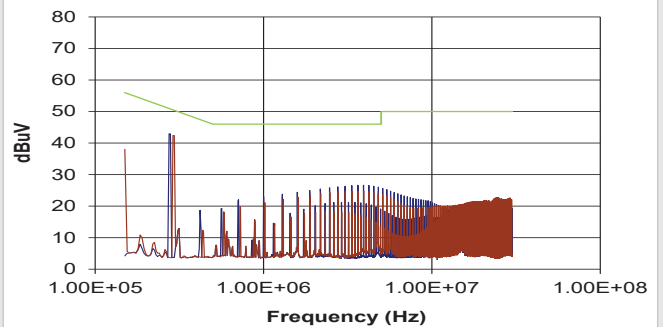

NXJ2S1212MC (Quasi Peak)

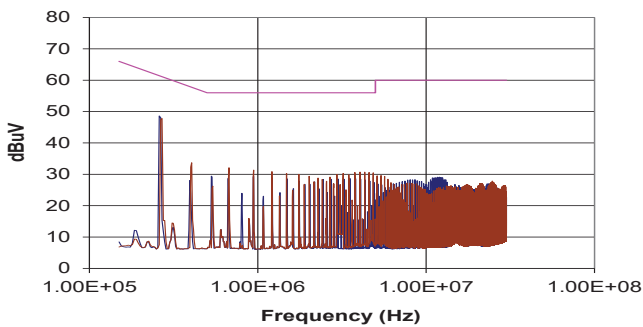

NXJ2S1212MC (Average)

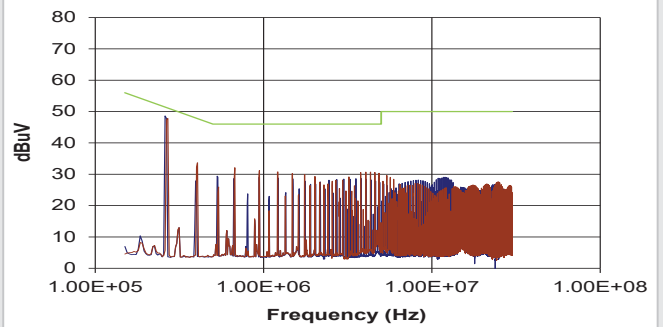

EMC FILTERING AND SPECTRA

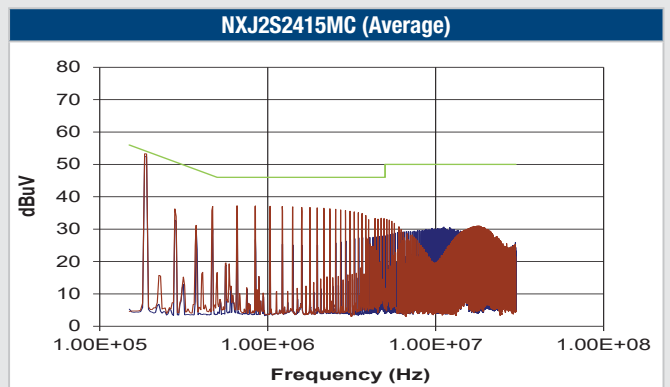
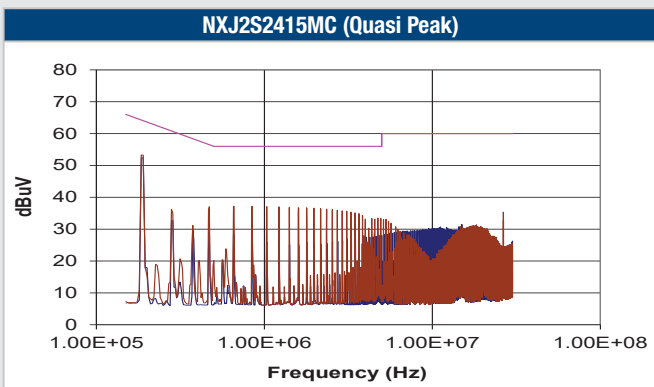
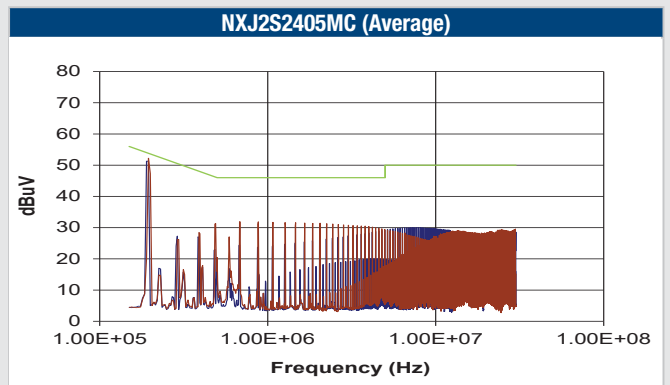
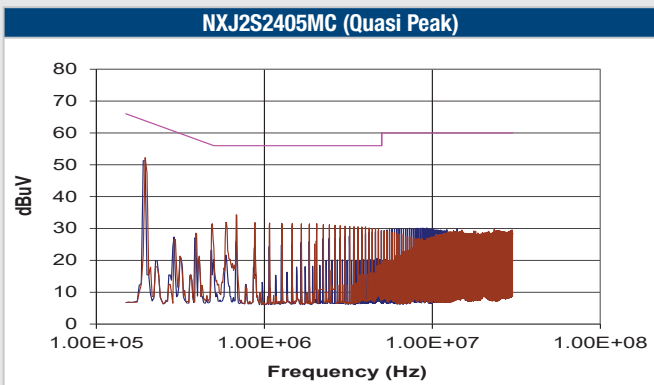
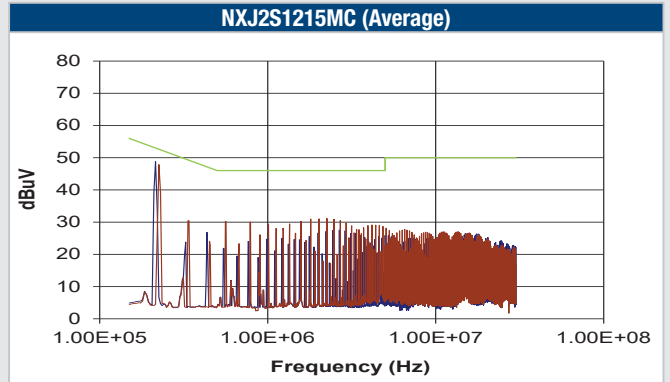
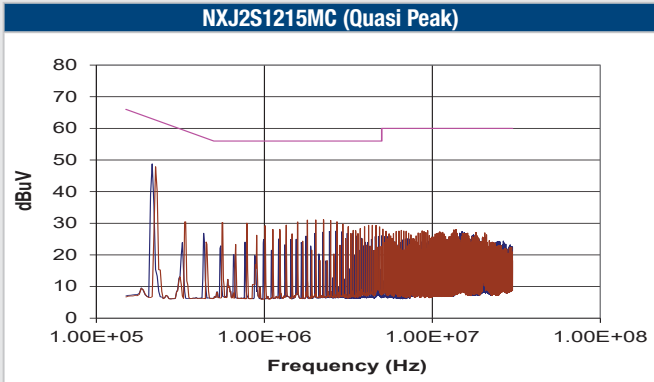

PACKAGE SPECIFICATIONS

Mechanical Dimensions - 5V & 12V Input Types

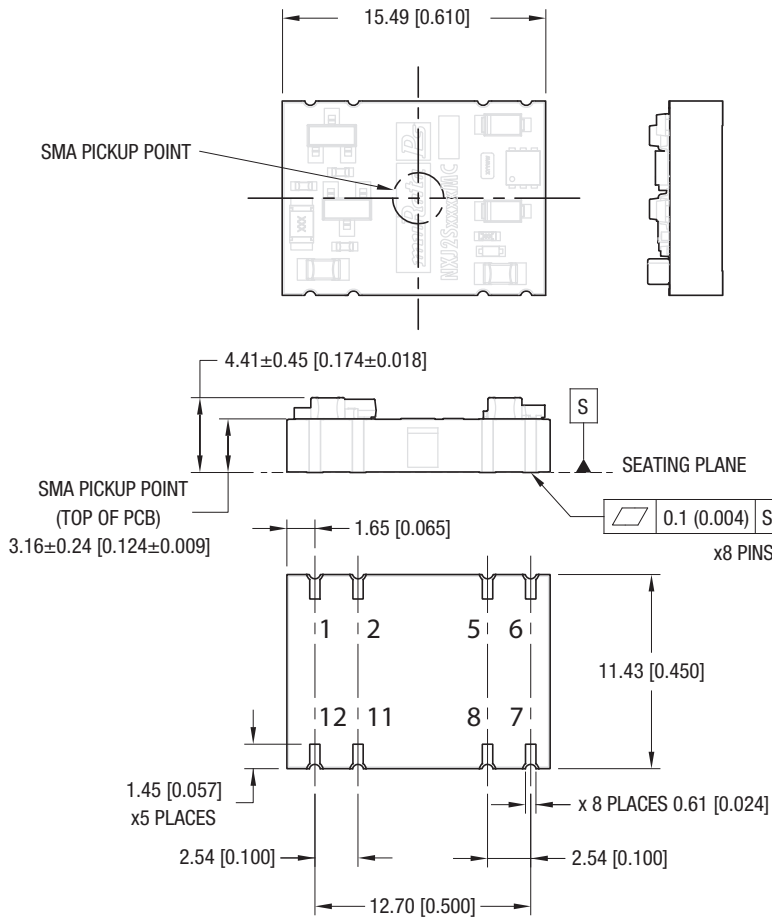

All dimensions in mm(inches). Controlling dimension is mm. Tolerances (unless otherwise stated) ±0.2 (0.008). Components shown for reference only

Weight: 1.38g

Pin Connections

| Pin | Function |
|-----|----------|
| 1 | +VIN |
| 2 | -VIN |
| 5 | -VOUT |
| 6 | +VOUT |
| 7 | NC |
| 8 | NC |
| 11 | -VIN |
| 12 | NC |

NC - No connection.

Recommended Footprint Details

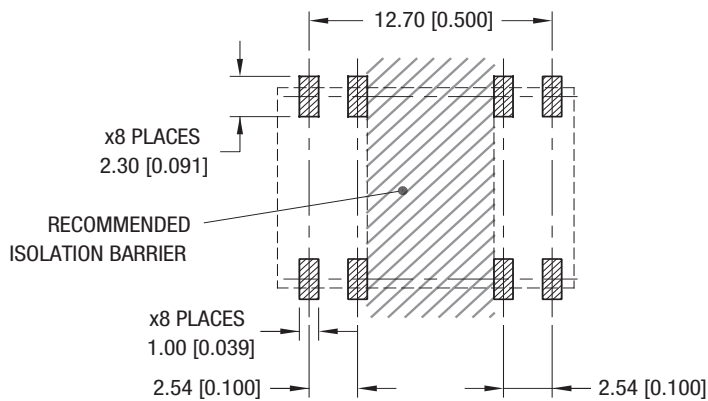

PACKAGE SPECIFICATIONS

Mechanical Dimensions - 24V Input Type

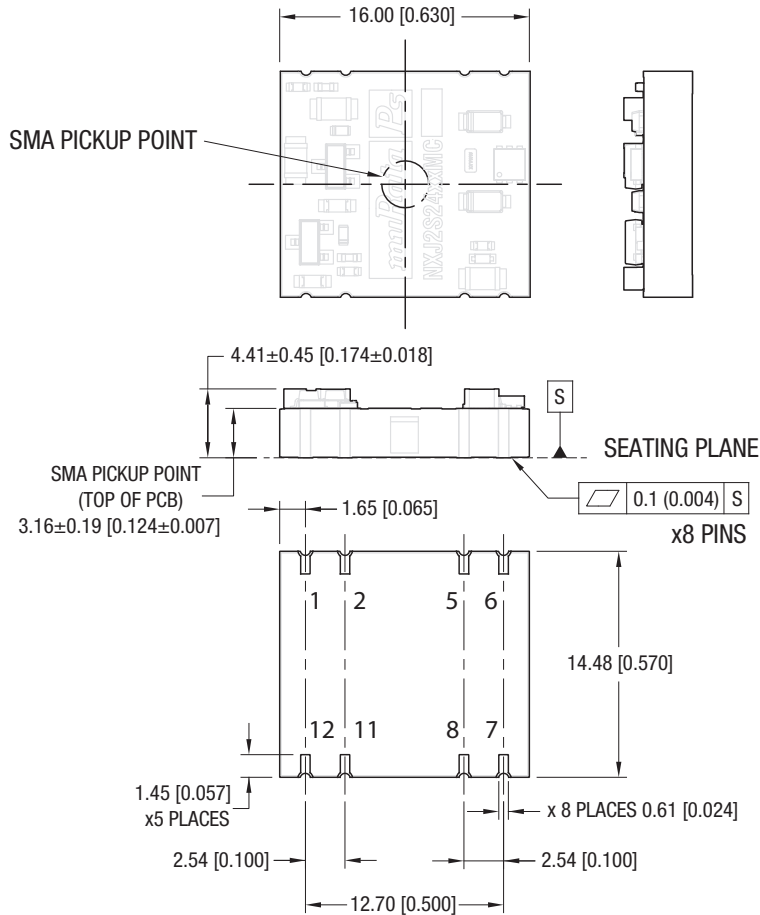

All dimensions in mm (inches). Controlling dimension is mm. Tolerances (unless otherwise stated) ±0.2 (0.008). Components shown for reference only.

Weight: 1.78g

Pin Connections

| Pin | Function |
|-----|----------|
| 1 | +VIN |
| 2 | -VIN |
| 5 | -VOUT |
| 6 | +VOUT |
| 7 | NC |
| 8 | NC |
| 11 | -VIN |
| 12 | NC |

NC - No connection.

Recommended Footprint Details

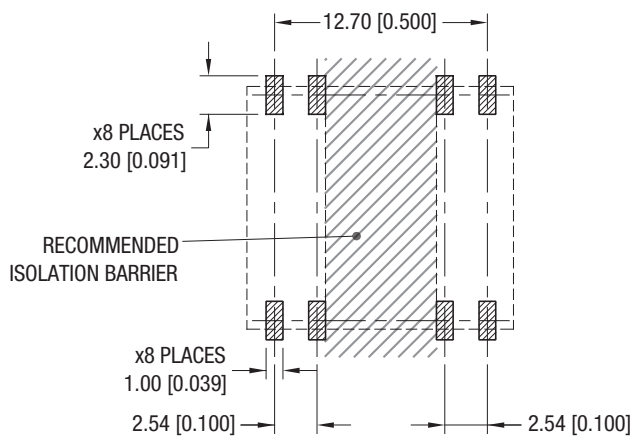

TAPE & REEL SPECIFICATIONS

TAPE OUTLINE DIMENSIONS - 5V & 12V Input Types

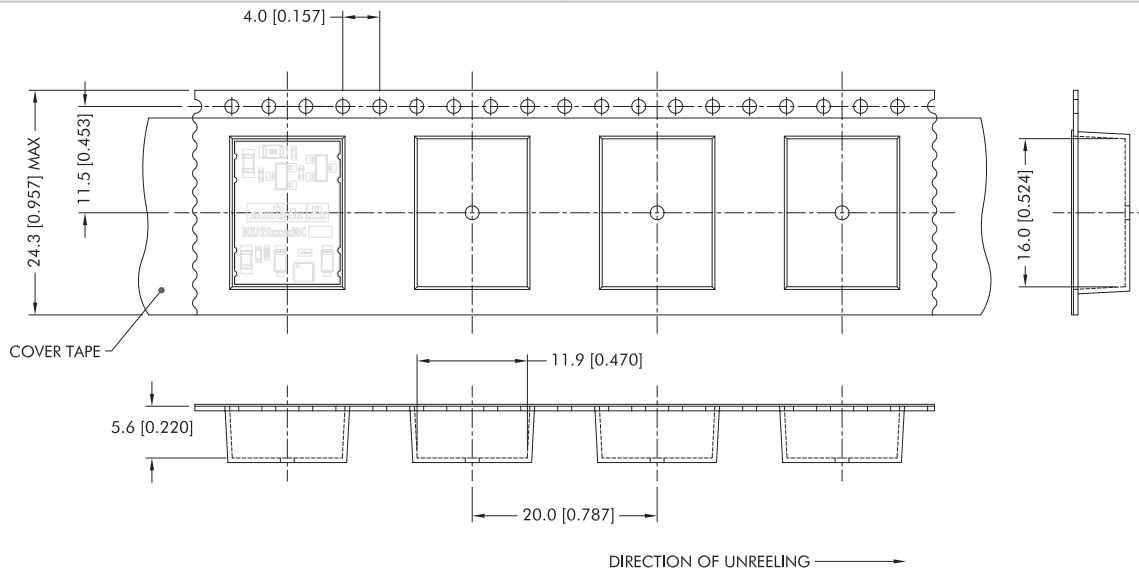

Tape & Reel specifications shall conform with current EIA-481 standard
 Unless otherwise stated all dimensions in mm(inches)
 Controlling dimension is mm
 Components shall be orientated within the carrier tape as indicated

TAPE OUTLINE DIMENSIONS - 24V Input Type

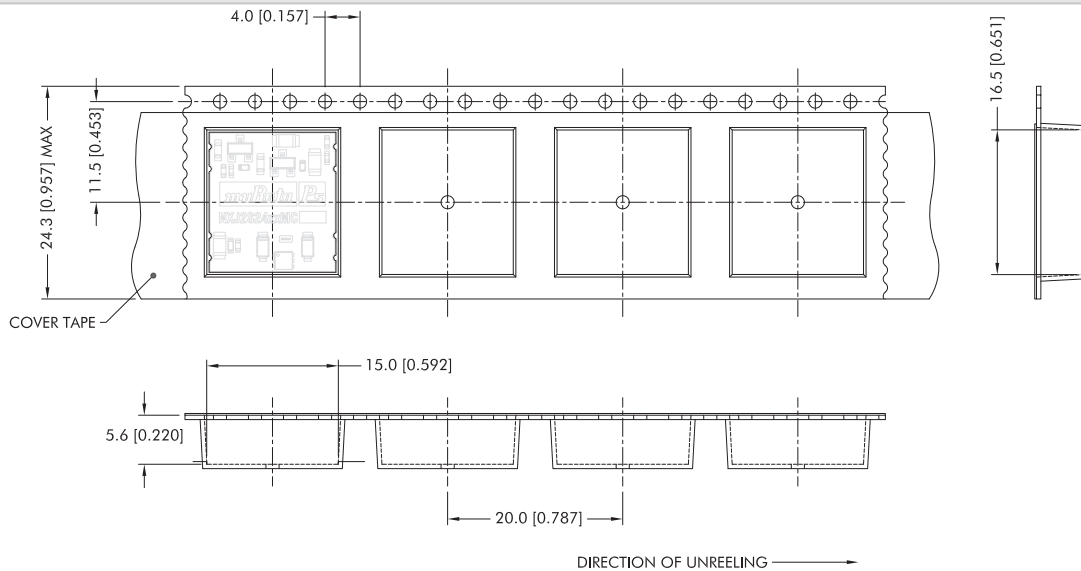

Tape & Reel specifications shall conform with current EIA-481 standard
 Unless otherwise stated all dimensions in mm(inches)
 Controlling dimension is mm
 Components shall be orientated within the carrier tape as indicated

TAPE & REEL SPECIFICATIONS CONTINUED

REEL OUTLINE DIMENSIONS

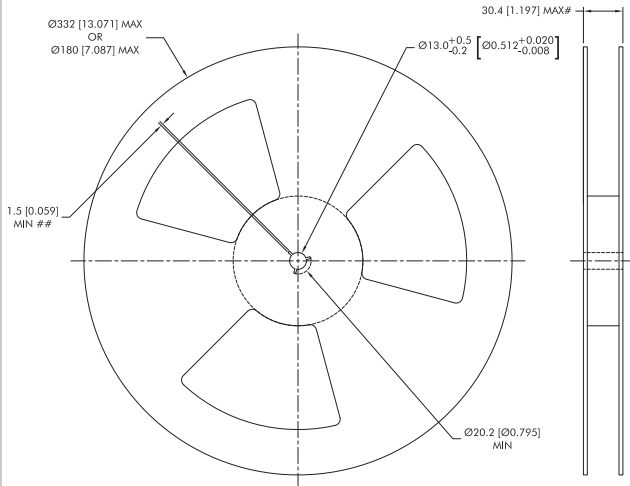

Tape & Reel specifications shall conform with current EIA-481 standard
 Unless otherwise stated all dimensions in mm(inches)
 Controlling dimension is mm
 # Measured at hub
 ## Six equi-spaced slots on 180mm/7" reel

REEL PACKAGING DETAILS

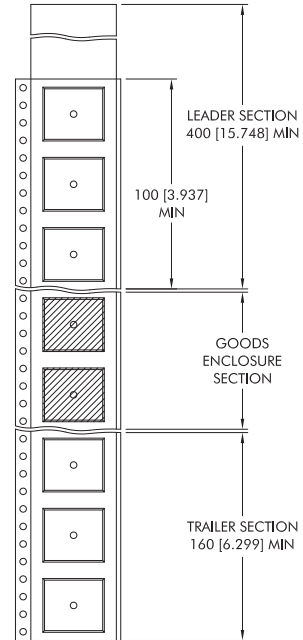

Carrier tape pockets shown are illustrative only - Refer to carrier tape diagram for actual pocket details.

Reel Quantity: 7" - 135 or 13" - 600



This product is subject to the following **operating requirements** and the **Life and Safety Critical Application Sales Policy**:

Refer to: <http://www.murata-ps.com/requirements/>

Murata Power Solutions, Inc. makes no representation that the use of its products in the circuits described herein, or the use of other technical information contained herein, will not infringe upon existing or future patent rights. The descriptions contained herein do not imply the granting of licenses to make, use, or sell equipment constructed in accordance therewith. Specifications are subject to change without notice. © 2019 Murata Power Solutions, Inc.