



Main

Range of product	Preventa Safety automation
Product or component type	Configurable safety controller
Safety module name	XPSMC
Safety use category	Category 4 maximum conforming to EN 954-1/EN/ISO 13849-1 PLE maximum conforming to EN/ISO 13849-1 SIL 3 maximum conforming to IEC 61508
Type of start	Configurable
Standards	EN 1760-1/ISO 13856-1 EN 574/ISO 13851 EN 954-1/EN/ISO 13849-1 EN/IEC 60204-1 EN/IEC 60947-5-1 EN/IEC 61496-1 IEC 61508
Product certifications	CSA TÜV UL
[Us] rated supply voltage	24 V DC - 20...20 %
Number of inputs	16
Communication port protocol	Modbus with 1 RJ45 port(s), serial link, transmission rate: 1200 bps, 2400 bps, 4800 bps, 9600 bps or 19200 bps
Safety level	Can reach PL e/category 4 conforming to EN 954-1/EN/ISO 13849-1 Can reach SIL 3 conforming to IEC 61508

Complementary

Function of module	Dynamic monitoring of hydraulic valves on linear presses Eccentric press Emergency stop monitoring, with or without time delay, 1 or 2-channel wiring Enabling switch monitoring, 2 or 3 contacts Foot switch monitoring Guard monitoring for injection presses and blowing machines Guard monitoring with 1 or 2 limit switches Hydraulic press Magnetic switch monitoring Monitoring safety stop at top dead centre on eccentric press Muting function of light curtains Position selector Safety mat monitoring Safety time delays
--------------------	--

Shaft/chain breaking monitor
 Zero speed detection
 Light curtain monitoring (category 4) conforming to EN/IEC 61496
 Two-hand control (category 3) conforming to EN 574/ISO 13851

Synchronisation time between inputs	Depending on configuration selected
Power consumption in W	12 W
Input protection type	External fuse 16 A
[Uc] control circuit voltage	28.8 V
Line resistance	100 Ohm 2000 m
Output type	2 relays, 2 NO contacts (4 NO total) circuit(s) Solid state, 6 circuit(s), volt-free
Breaking capacity	C300 : holding 180 VA AC-15 for relay output C300 : inrush 1800 VA AC-15 for relay output
Breaking capacity	1.5 A / 24 V - L/R = 50 ms, DC-13 for relay output 2 A / 24 V for static output circuit
Output thermal current	4 A for both outputs simultaneously 6 A for 1 output and 2 A for the other for relay output
[I _{th}] conventional free air thermal current	<= 16 A for relay output <= 6.5 A for static output circuit
Associated fuse rating	16 A gL for power supply 4 A gL for relay output 6 A fast blow for relay output
Minimum output current	10 mA for relay output
Minimum output voltage	17 V for relay output
Response time	Configurable : 20 ms or 30 ms with software XPSMCWIN
[U _i] rated insulation voltage	300 V, degree of pollution 2 conforming to IEC 60647-5-1, DIN VDE 0110 part 1
[U _{imp}] rated impulse withstand voltage	4 kV overvoltage category III conforming to IEC 60647-5-1, DIN VDE 0110 part 1
Method of access	Slave
Exchange size	14 words
Number of addresses	1...247 for Modbus
Parity	Even for Modbus No for Modbus Odd for Modbus
Data format	1 start bit/8 data bits 1 stop bit even or odd 2 stop bits without parity RTU (Remote Terminal Unit) mode
Supported modbus function	01: 8-bit output data/32-bit input data 02: 32-bit input data/8-bit output data 03: information and errors
Local signalling	30 LEDs
Mounting support	Mounting plate
Depth	153 mm
Height	151.5 mm
Width	74 mm
Product weight	0.82 kg

Environment

IP degree of protection	IP20 conforming to EN/IEC 60529
Ambient air temperature for operation	-10...55 °C
Ambient air temperature for storage	-25...85 °C

Contractual warranty

Warranty period	18 months
-----------------	-----------

Dimensions

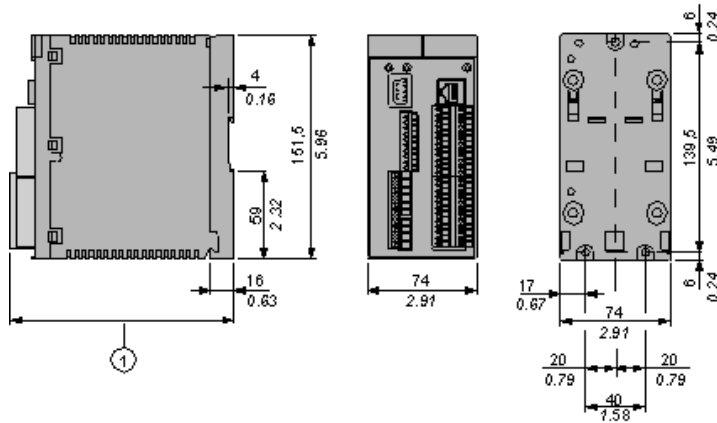

- 1 When using XPSMCTS• connectors this dimension is 153 mm (6.02 in)
When using XPSMCTC• connectors this dimension is 151,5 mm (5.96 in)

Installation

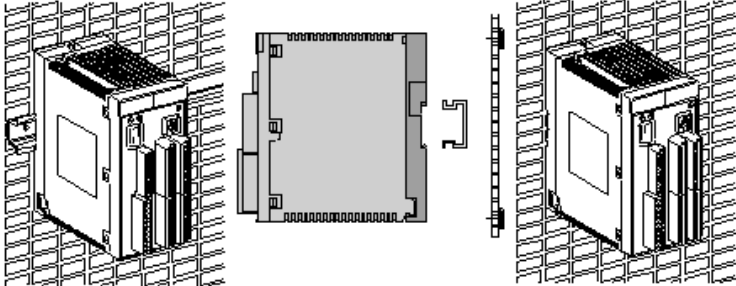

Metal adaptor for fixing on metal: DIN rail 35 mm/1.38 in.

Wiring Diagrams

Refer to the Instruction Sheet

To download the instruction sheet, follow below procedure:

XPSAC5121
module XPSAC - Emergency stop - 24 V AC DC
[Download XPSAC5121 product datasheet](#)

Download & Documents 1 to 3 of 3 (Total: -1)

Instruction sheet

XPSAC... Safety module for emergency stop and switch monitoring	English 2012-07-04	pdf (29)
---	--------------------	----------

Image of product

Emergency stop and switch monitoring	2010-11-10	(Select :)
--------------------------------------	------------	------------

Certificate



Russian certificate	English 2010-07-07	pdf (60)
---------------------	--------------------	----------



1

2

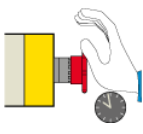
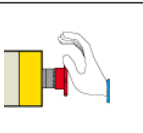
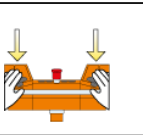
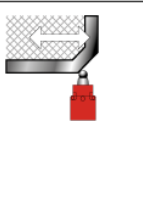
- 1 Click on Download & Documents.
- 2 Click on Instruction sheet.

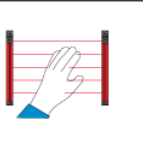
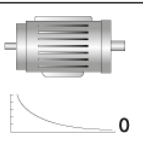
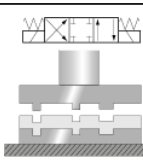
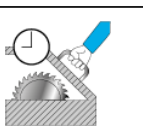
Safety Functions

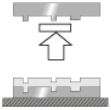
	<ul style="list-style-type: none"> • Emergency stop monitoring with time delay: <ul style="list-style-type: none"> ○ 1 channel wiring, with automatic start. ○ 2 channel wiring, with start button.
	<ul style="list-style-type: none"> • Emergency stop monitoring without time delay: <ul style="list-style-type: none"> ○ 1 channel wiring, with automatic start. ○ 2 channel wiring, with start button.
	<ul style="list-style-type: none"> • Two-hand control.
	<ul style="list-style-type: none"> • Guard monitoring: <ul style="list-style-type: none"> ○ with 1 limit switch. ○ with 2 limit switches. ○ with 2 limit switches, with guard locking. • Guard monitoring for injection presses and blowing machines.
	<ul style="list-style-type: none"> • Magnetic switch monitoring.
	<ul style="list-style-type: none"> • Sensing mat monitoring.
	<ul style="list-style-type: none"> • Light curtains monitoring: <ul style="list-style-type: none"> ○ Relay output type. ○ Solid-state output type. • "Muting" function for light curtains.
	<ul style="list-style-type: none"> • Zero speed detection.
	<ul style="list-style-type: none"> • Dynamic monitoring of hydraulic valves on linear presses.
	<ul style="list-style-type: none"> • Safety time delays.

	<ul style="list-style-type: none"> • Monitoring safety stop at top dead centre on eccentric press. • Hydraulic press. • Eccentric press.
	<ul style="list-style-type: none"> • Enabling switching monitoring: <ul style="list-style-type: none"> ○ 2 contact type. ○ 3 contact type.

Other functions:

- Foot switch monitoring
- Chain shaft breakage monitoring
- Position selector