

Implementing All-in-One PC Power Supply Evaluation Board User's Manual

PC Power Supply with the NCP13992, NCP1616, NCP4306 and NCP431

Description

This evaluation board user's manual provides basic information about a high efficiency, low no-load power consumption reference design that was tailored to power All-in-One PC or similar type of equipment that accepts 12 VDC on the input. The power supply implements PFC front stage to assure unity power factor and low THD, current mode LLC power stage to enhance transient response and secondary side synchronous rectification to maximize efficiency. This design note focuses mainly on the NCP13992 current mode LLC controller description. Please use links in literature section to get materials about NCP1616, NCP4306 and NCP431 to gain more information about these devices.

The NCP13992 is a high performance current mode controller for half bridge resonant converters. This controller implements 600 V gate drivers, simplifying layout and reducing external component count. The Controller also features built-in high voltage startup. The Brown-Out input function eases implementation of the controller in all applications. In applications where a PFC front stage is needed, the NCP13992 features a dedicated output to drive the PFC controller. This feature together with quiet skip mode technique further improves light load efficiency of the whole application. The NCP13992 provides a suite of protection features allowing safe operation in any application. This includes: overload protection, over-current protection to prevent hard switching cycles, brown-out detection, open optocoupler detection, automatic dead-time adjust, over-voltage (OVP) and over-temperature (OTP) protections. The LLC current mode means that the operating frequency of an LLC converter is not controlled via voltage (or current) controlled oscillator but is directly derived from the resonant capacitor voltage signal and actual feedback level. This control technique brings several benefits compare to traditional voltage mode controllers like improved line and load transient response and inherent out of zero voltage switching protection.

Table 1. GENERIC PARAMETERS

Device	Applications	Input Voltage	Nominal Output Voltage/Current	Output Power	V _{OUT} Ripple
NCP1616, NCP13992, NCP4306	AOI, Server Power	90 – 265 Vac	12 Vdc / 20 A	240 W	< 150 mV @ Full load
Efficiency @ 230 V AC	Standby Power	Operating Temperature	Cooling	Topology	Board Size
4 point AVG 94.11%	< 135 mW	0 – 40°C	Convection Open Frame, Forced in Frame	PFC CrCM LLC + SR	194 × 108 × 27 mm 7.11 W/inch ³



ON Semiconductor®

www.onsemi.com

EVAL BOARD USER'S MANUAL

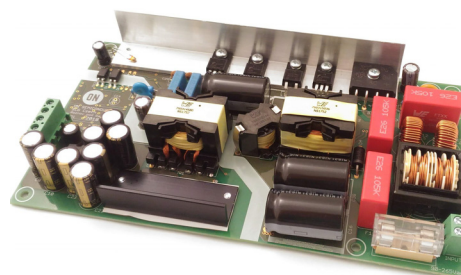

Figure 1. Evaluation Board Picture

Key Features

- Wide Input Voltage Range
- High Efficiency
- Low No-load Power Consumption
- No Auxiliary SMPS, Fast Startup
- X2 Capacitor Discharge Function
- Near Unity Power Factor
- Low Mains & Overload Protection
- Thermal Protection
- Regulated Output Under any Conditions
- Excellent Load & Line Transient Response
- All Magnetics Available as Standard Parts
- Small Form Factor
- Universal Design for Multiple Controllers Assembling Possibilities
- Extremely Low No-load Consumption

EVBUM2566/D

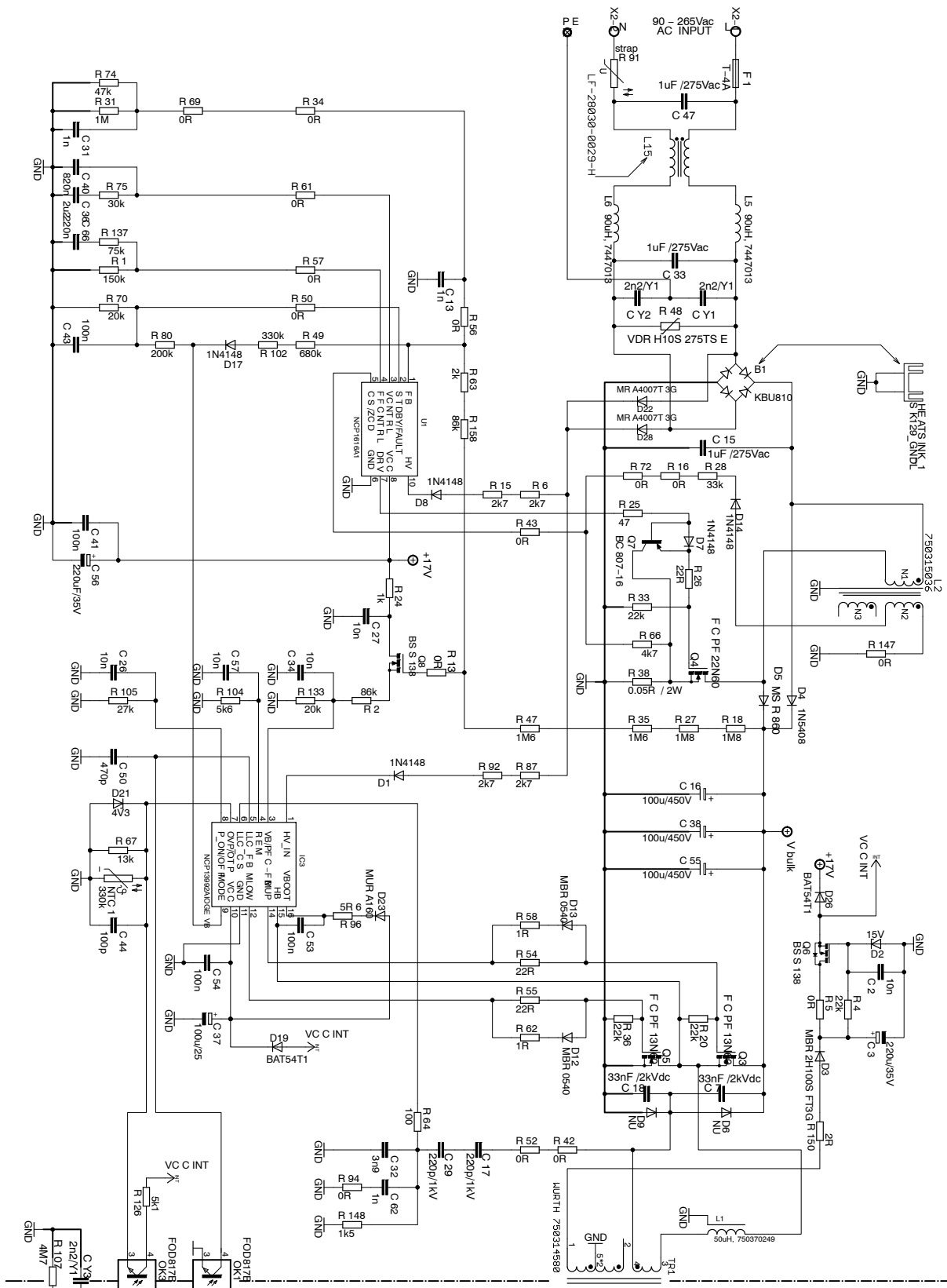

Figure 2. AOI Demo-board Schematic – Primary Side
(Assembled Options on Standard Revision of the Demo)

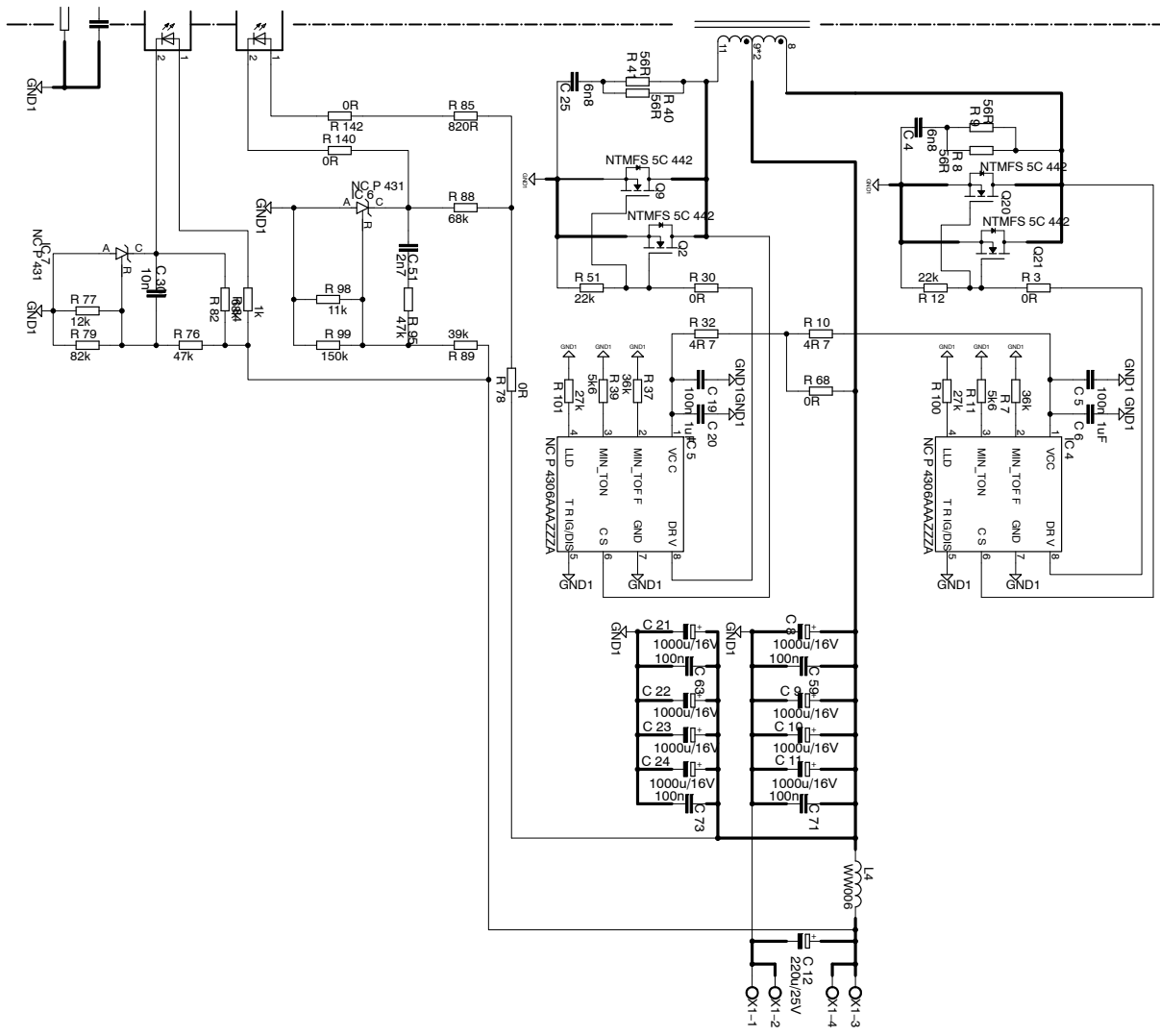

Figure 3. AOI Demo-board Schematic – Secondary Side
(Assembled Options on Standard Revision of the Demo)

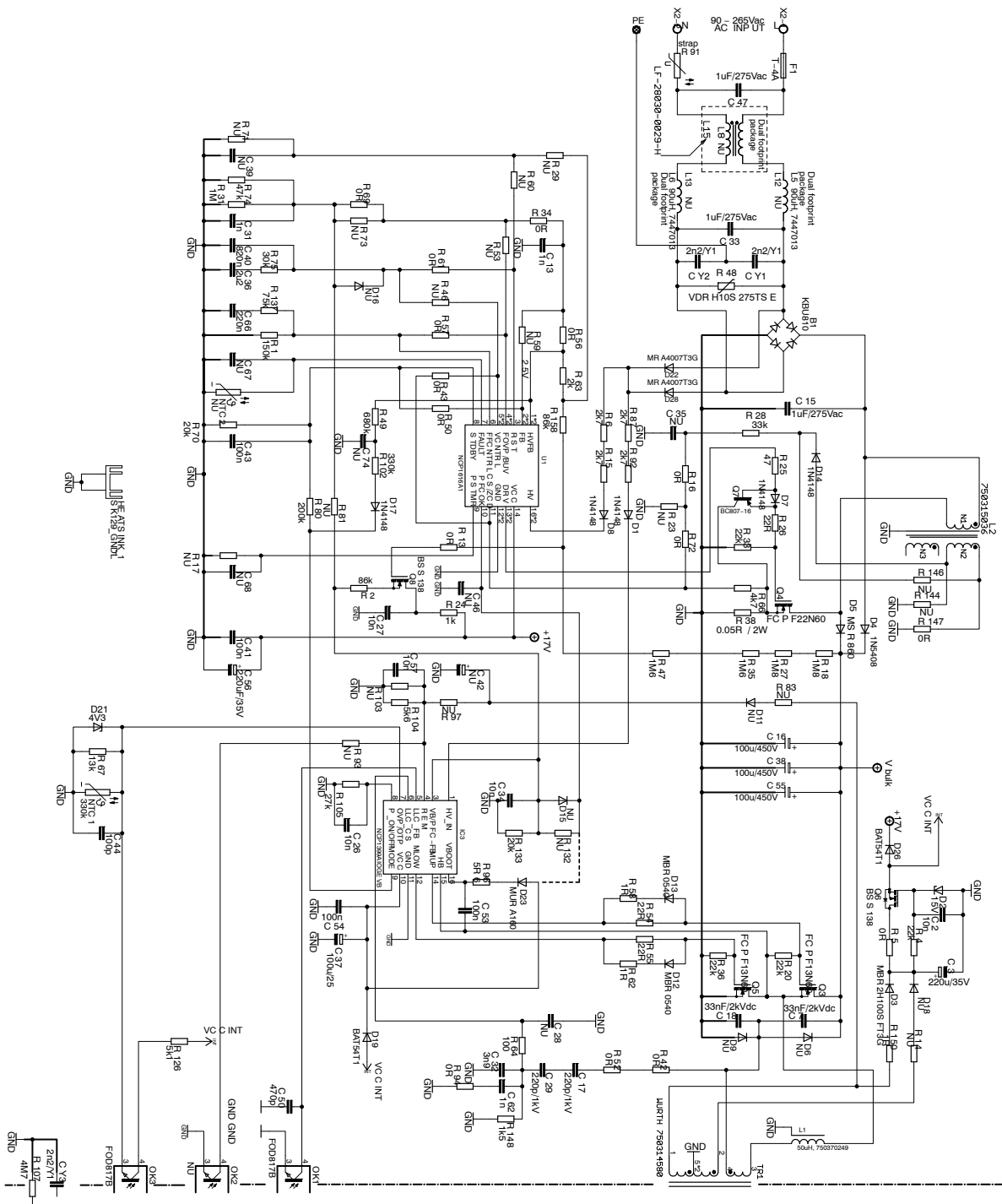

Figure 4. AOI Demo-board Schematic – Primary Side
(Assembled and also All Other Possible Options in PCB Layout)

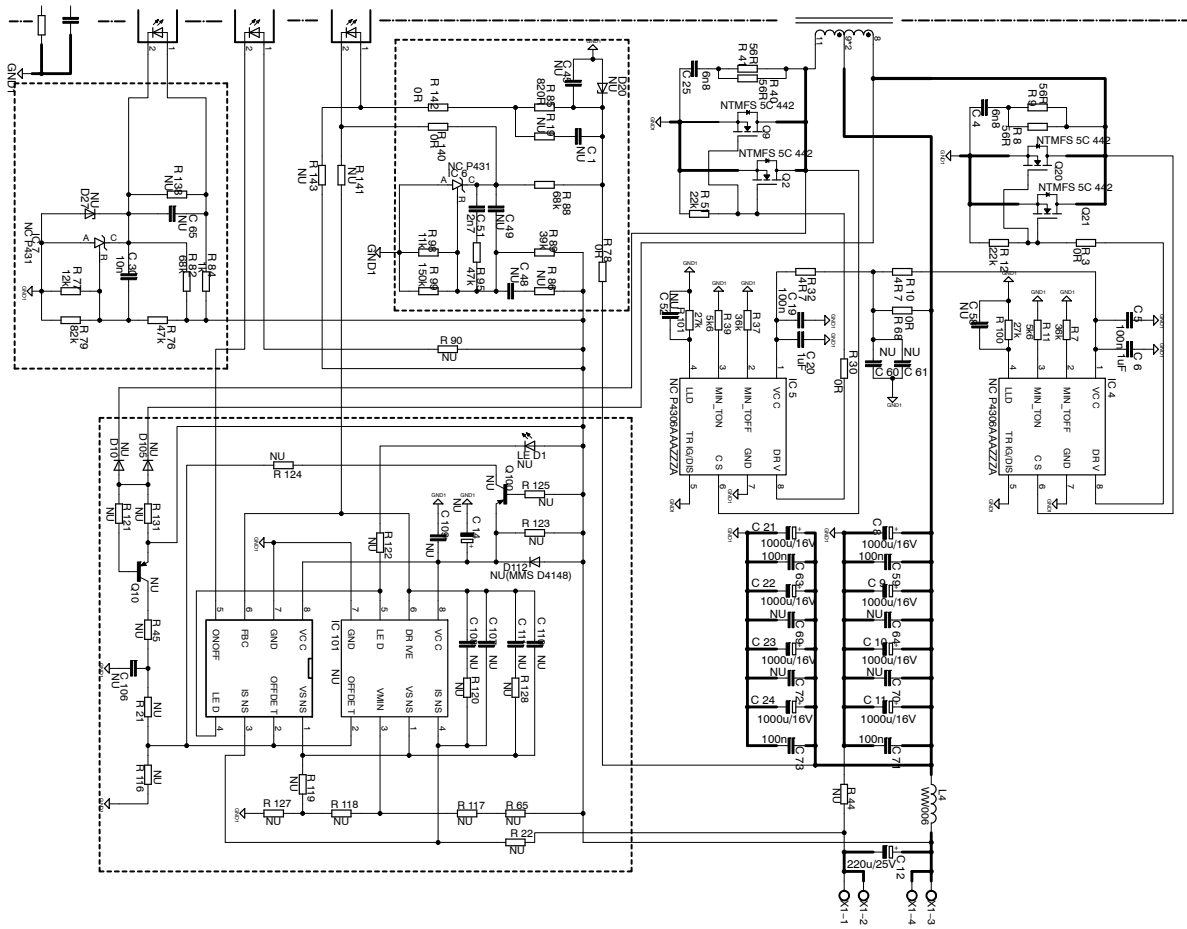

Figure 5. AOI Demo-board Schematic – Secondary Side
(Assembled and also All Other Possible Options in PCB Layout)

Detailed Descriptions of the Evaluation Board

The input EMI filter is formed by components L15, L5, L6, C47, C33, CY1, CY2 and R48 – refer to Figure 2. The inrush current limiting resistor R91 is substituted by strap in this demo revision – one can replace it by appropriate NTC inrush current limiter if needed. The U1 – NCP1616 (Figure 2) with diodes D22, D28 and resistors R6, R15 is used to X2 capacitor discharge function after application is disconnected from the mains. This circuit also provides PFC Vcc Start-up feature and input voltage sensing, also is partly shared for the LLC controller IC. The Power Factor Corrector (PFC) power stage uses standard boost PFC topology formed by power components B1, C15, L2, D4, D5, Q4, R38, and bulk capacitors C16, C38, C55. The PFC controller U1 (NCP1616) senses input voltage directly via pin 10 (HV) through network above mentioned. The PFC inductor current is sensed by the shunt resistor R38. The series resistor R38 sets maximum PFC front stage peak current. Maximum peak current level is to 10 A. The PFC feedback divider is shared with LLC brown-out sensing network in order to reduce application no-load power consumption. The PFC FB divider is formed by resistors R18, R27, R35, R47, R158, R63, R56, R34, R69, R74 and R31. The FB signal is filtered by capacitor C13 and C31 to overcome possible difficulties caused by the parasitic capacitive coupling between pin and other nodes that handle high dV/dt signals. The internal bulk voltage regulator compensation C40, C36, R75 is connected through R61 to the U1 pin 3. The PFC MOSFET is driven via circuitry R25, D7, R26, R33 and Q7. This solution enables to define needed turn-on and turn-off process speed for Q4. The PNP transistor Q7 is connected directly source of Q4 (not through sensing shunt R38) to minimize discharge loop and thus allow fast turn off PFC switch and also minimizing EMI caused by the driver loop. The PFC coil auxiliary winding voltage after rectifying with D14 provides ZCD signal for PFC controller. The NCP1616 has shared pin 5 – CS/ZCD for current limit and zero current detection. During turned-on Q4 is sensed and limited maximum input current and after turning-off Q4 is detected zero current condition. The resistance of R66 should be bigger than 3.9 kΩ to avoid wrong detection of destroyed R38. Also, resistance R28 should be reasonable high enough to limit no-load and light-load consumption.

The LLC power stage primary side converter composes from these devices: MOSFETs Q3, Q5, external resonant inductor L1, transformer TR1 and resonant capacitors C7, C18. The IC3(NCP13992AIOGEVB) LLC controller senses primary current indirectly – via resonant capacitor voltage monitoring which is divided down by capacitive divider C17, C29, C32 and C62. The capacitive divider has to provide minimum phase shift between resonant capacitor signal and divided signal on the LLC_CS pin. The capacitive divider has to be loaded in the same time to assure fast LLC_CS pin signal stabilization after application startup – this is achieved by resistor R148. The series resistor R64 is used to limit maximum current that can flow into the

LLC_CS pin. The FB optocoupler OK1 is connected to the LLC_FB pin and defines converter output voltage by pulling down this pin when lower output power is needed. Capacitor C51 forms high frequency pole in FB loop characteristics and helps to eliminate eventual noise that could be coupled to the FB pin by parasitic coupling paths. The Brown-out signal for LLC controller is derived from PFC feedback divider – described before. A voltage taken from node R13, R47 and R158, is impedance separated by voltage follower Q8, which helps to avoid influencing bulk voltage regulation. The voltage follower output feeds R2 and R133 divider, which is minimizing Q8 thresh-hold voltage temperature dependency. Divider output is filtered with C34 and connected to IC3 VB/PFC-FB pin. The Skip/REM pin of the NCP13992 issued for skip threshold adjustment. Resistors R103 and R104 are used for this purpose together with noise filtering capacitor C57. The over-voltage and over-temperature protections are implemented via OVP/OTP pin by using resistors R126 and R67, temperature dependent resistor NTC1, Zener-diode D21, filtering capacitor C44 and optocoupler OK3. The OVP comparator is located on the secondary side to assure maximum OVP circuitry accuracy. The pin 8 P_ON/OFF is actually used for defining minimum feedback voltage – lower saturation level, which influences maximum switching frequency. For this purpose serve R105 and C26 decouples noise. The stand-by mode – burst mode of the PFC stage and bulk voltage are controlled by NCP13992 via MODE pin 9, which goes high during LLC stage switching and during idle falls to low level. While skip mode operation occurs, the LLC controller forces the PFC controller into STAND-BY mode by the MODE pin 9 via circuitry R80, C43, R70 and R50. Positive hiccup mode is implemented such way, that MODE pin influences FB divider and changes lower restart level from lower value to higher value. This is realized by network with D17, R102 and 49. These changes help to achieve very low no-load consumption.

The VCC decoupling capacitor C54 and also bootstrap capacitor for high side driver powering C53 are located as close to the LLC controller package as possible to minimize parasitic inductive coupling to other IC adjust components due to high driver current peaks that are present in the circuit during drivers rising and falling edges transitions. The bootstrap capacitor is charged via HV bootstrap diode D23 and series resistor R96 which limits charging current and Vboot to HB power supply slope during initial C53 charging process. The gate driver currents are reduced by added series resistors R54, R55 to optimize EMI signature of the application. For fastening the mosfets turn-off process are used serial R-D particles composed with R58-D13 and R62-D12. The primary controllers bias voltage limiter circuitry is used in order to restrict upper value of the primary VCC voltage to approximately 13 V. The VCC limiter composes of these components: resistors R150, R4, R5 capacitors C2, C3, diodes D3, D26 and transistor Q6. The secondary side synchronous rectification uses IC4 and IC5

SR controllers – NCP4306. Two MOSFETs are connected in parallel for each SR channel to achieve low total drop – Q2, Q9 and Q20, Q21. RC snubber circuits C4, R8, R9 and C25, R40, R41 are used to damp down the parasitic ringing and thus limit the maximum peak voltage on the SRMOSFETs. The SR controllers are supplied from converter output via resistors R68, R10 and R32. These resistors form RC filter with decoupling capacitors C5, C6 and C19, C20. The minimum on-time – R11, R39 and minimum off-time – R7, R37 resistors define needed blanking periods that help to overcome SR controllers false triggering to ringing in the SR power stage. Each SR controller uses very clever light load detection feature (LLD). After first incoming pulse from burst, the LLD feature wakes-up controller from low power mode (50 μ A) and prepare it to operate. As last pulse from the burst ends controller enters to stand-by mode after defined period, which is set with resistor (R100 and R101). Instead of the complicated light-load guard circuitry, just one additional resistor is needed for setup. The NCP4306 LLD feature offers great benefits compare to the traditional solutions, in which SR operation and no-load consumption is much less efficient. The output filtering capacitor bank composes from low ESR electrolytic capacitors C8 to C11, C21 to C24 and ceramic capacitors C59 to C73. Output filter L4, C12 is used to smooth output voltage from switching glitches. L4 is 600 nH inductor in case of need can be replaced with different product which enables higher dI/dt slope load. The output voltage of the converter is regulated by standard shunt regulator NCP431–IC6. The regulation optocoupler

OK1 is driven via resistor R85 which defines loop gain. The NCP431 is biased via resistor R88 in case there is no current flowing via regulation optocoupler – which can happen before the nominal VOUT level is reached or during transients from no-load to full-load conditions. The output voltage is adjusted by divider R89 and R98, R99. The feedback loop compensation network is formed partially by resistor R95 and capacitor C51. The secondary side OVP sense circuitry is also using NCP431 reference (IC7) to achieve precise OVP trip point. The OVP threshold is adjusted by resistor divider R76, R77 and R79. The bias current of OVP optocoupler OK3 is limited by resistor R84 and IC7 is biased via resistor R82. Capacitor C30 slows down OVP reaction speed and helps overcome false triggering by noise. There are several options prepared in the PCB layout so that customer can modify demo-board according to required of target application – please refer to Figure 4 and 5 for schematic that shows all options included in the PCB. The PCB consists of a 2 layer FR4 board with 70 μ m copper thickness to minimize parasitic resistance in secondary side where high currents are conducted. Leaded components are assembled from the top side of the board and all SMT components are place from the bottom only so that wave soldering process can be used for production. The board was design to work as open frame with natural air flow cooling. The LLC transformer temperature reaches approximately 90°C for $T_{ambient} = 25^{\circ}C$ and full load. Forced air flow cooling management should be considered in case the board is packed into some box or target application.

EVBUM2566/D

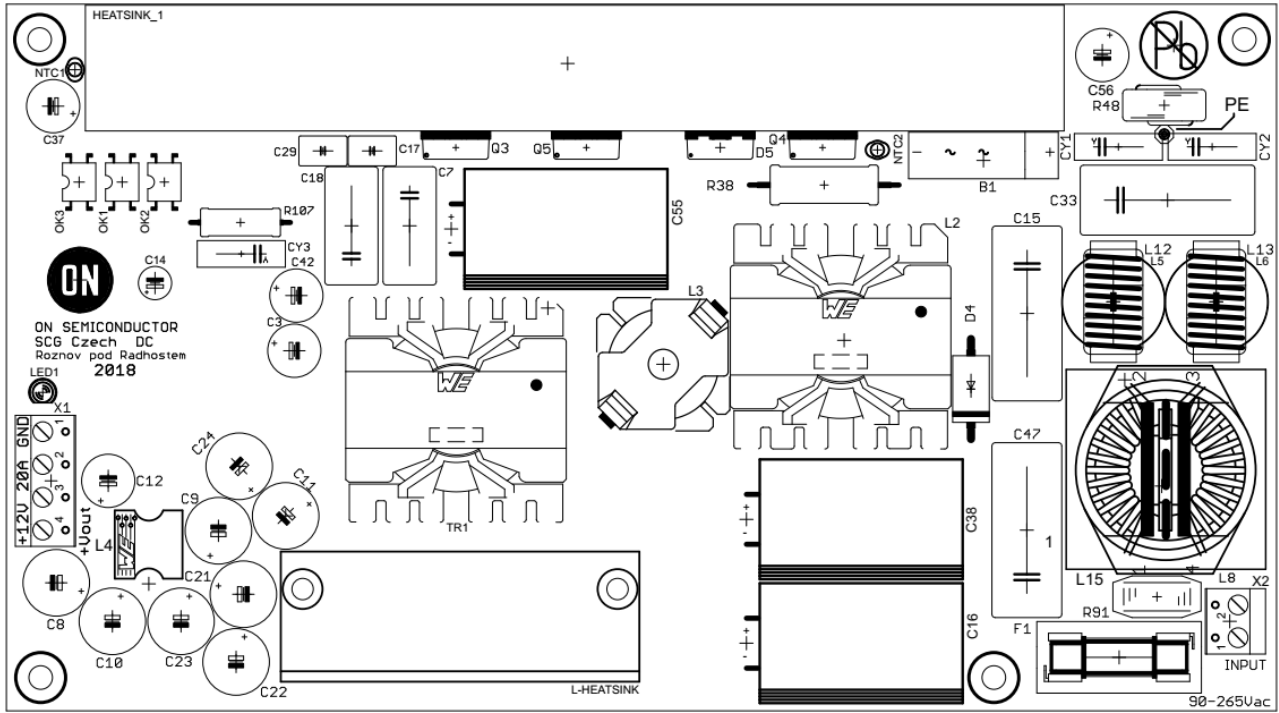

Figure 6. Evaluation Board – Top Side Components

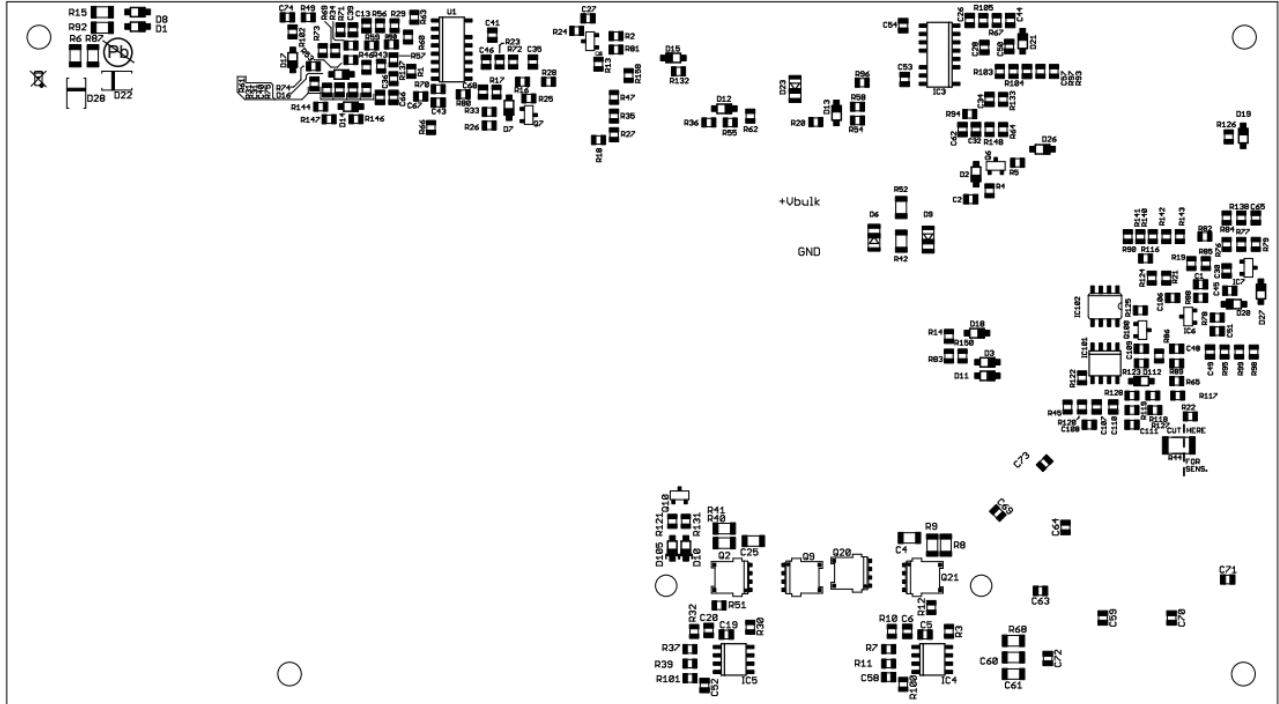

Figure 7. Evaluation Board – Bottom Side Components

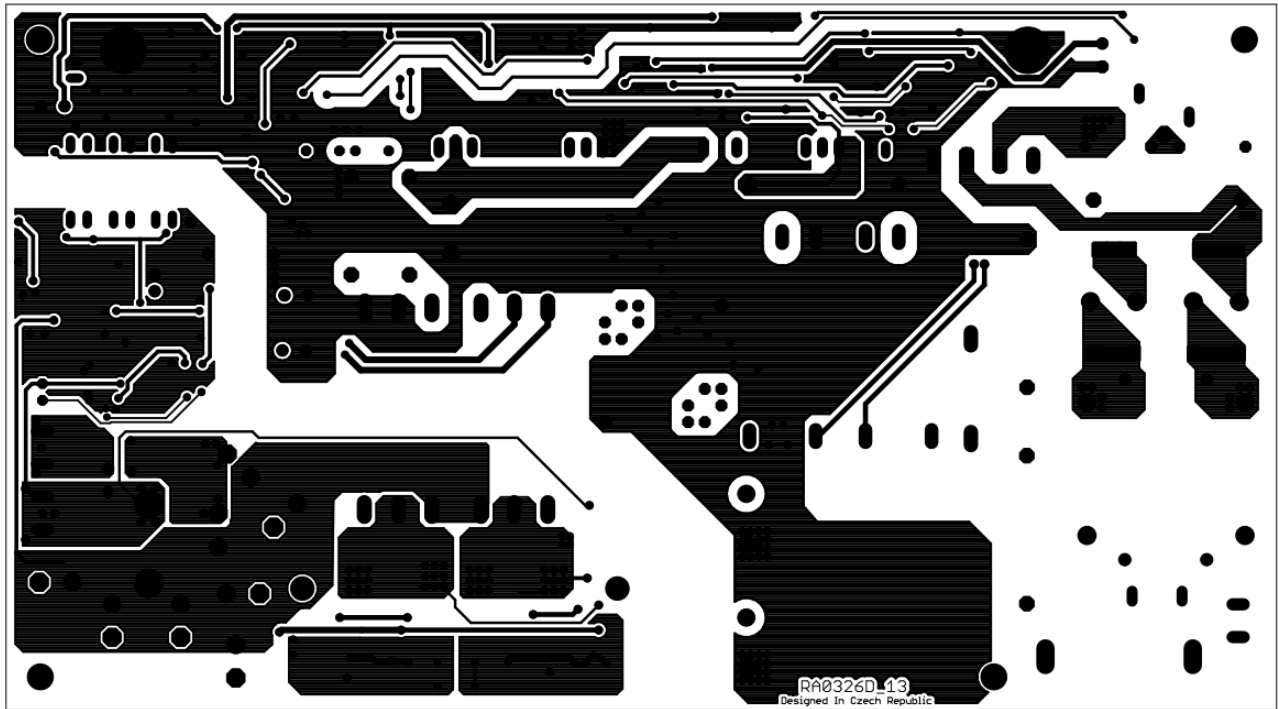

Figure 8. Evaluation Board – Top Layer

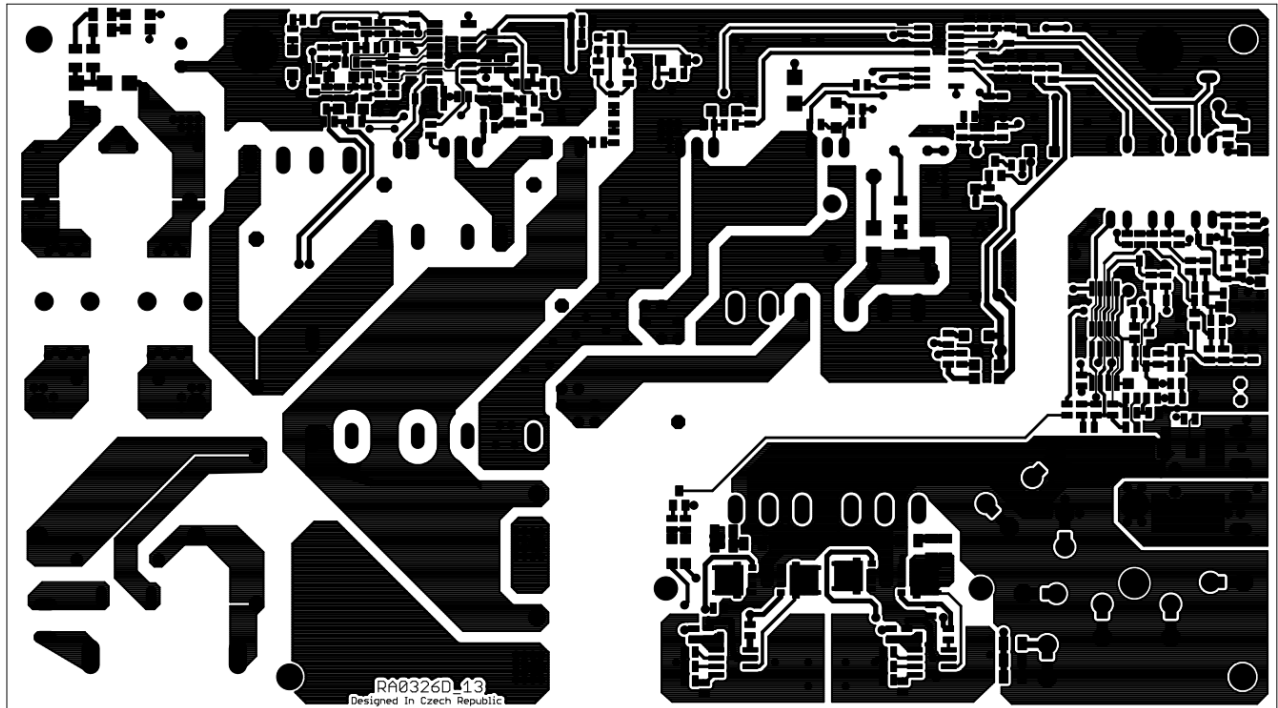

Figure 9. Evaluation Board – Bottom Layer Blue

EVBUM2566/D

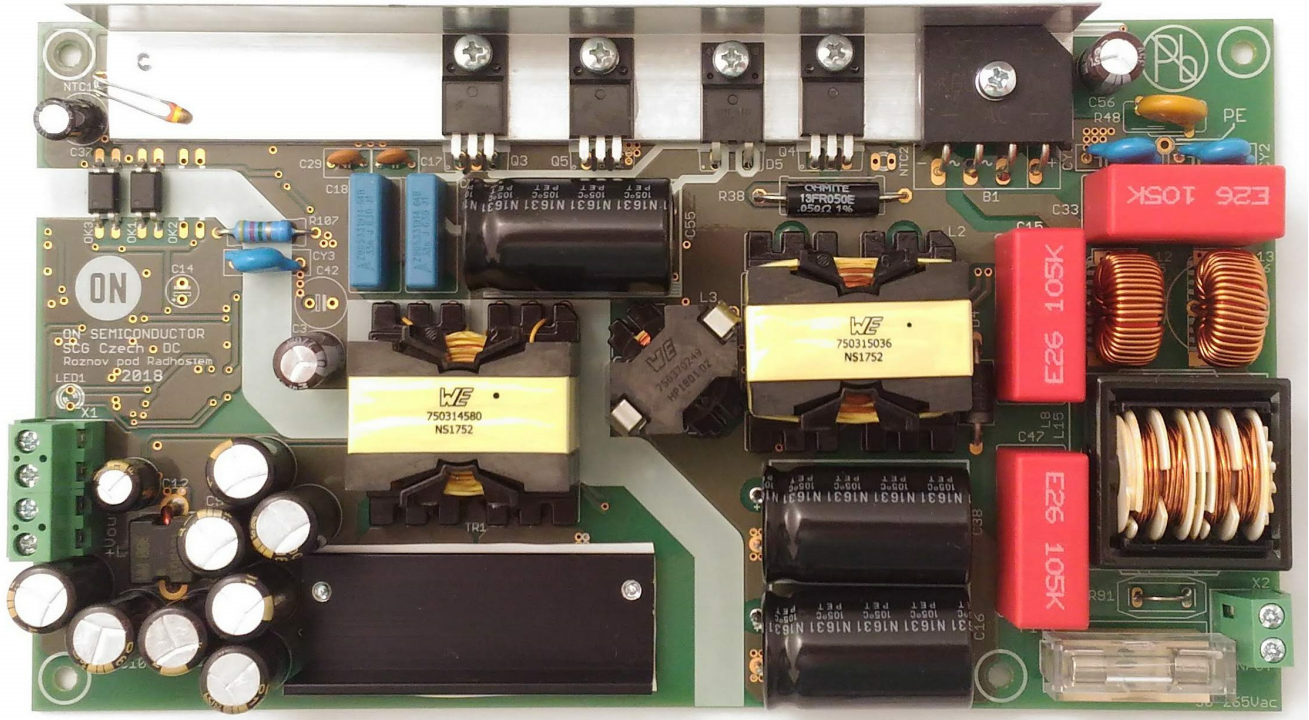

Figure 10. Evaluation Board Photograph – Top View

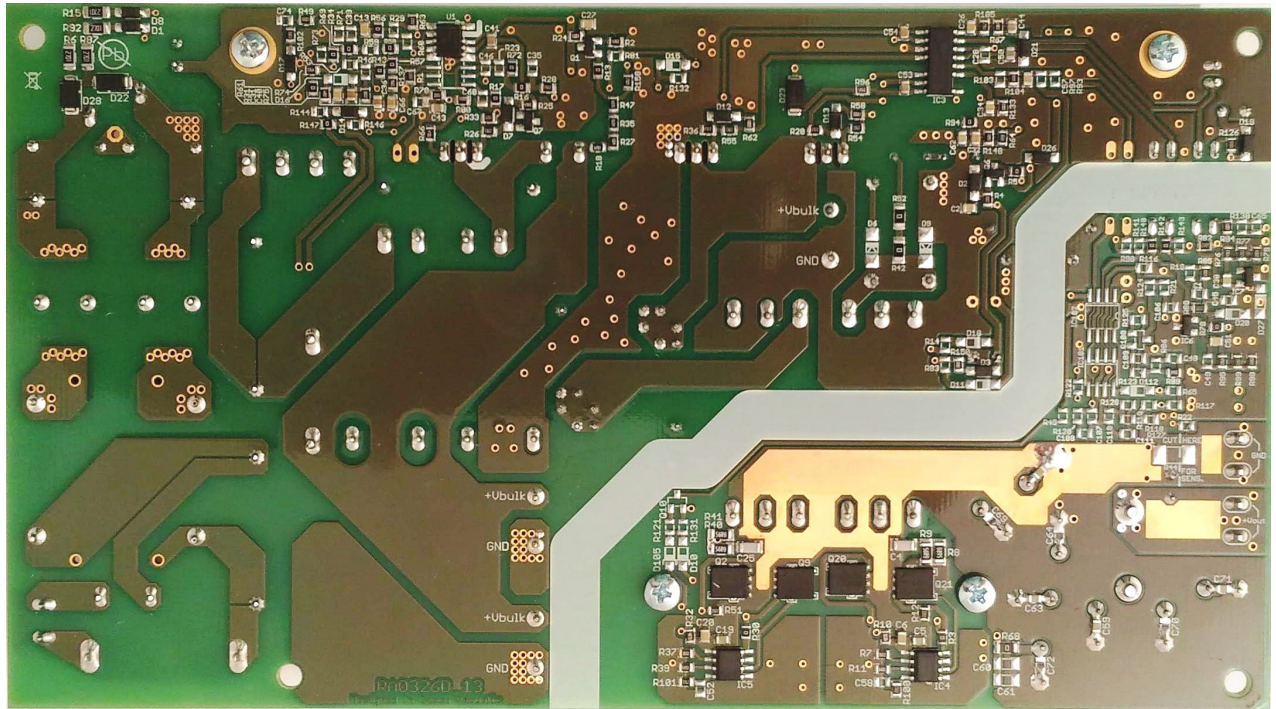

Figure 11. Evaluation Board Photograph– Bottom View

EVBUM2566/D

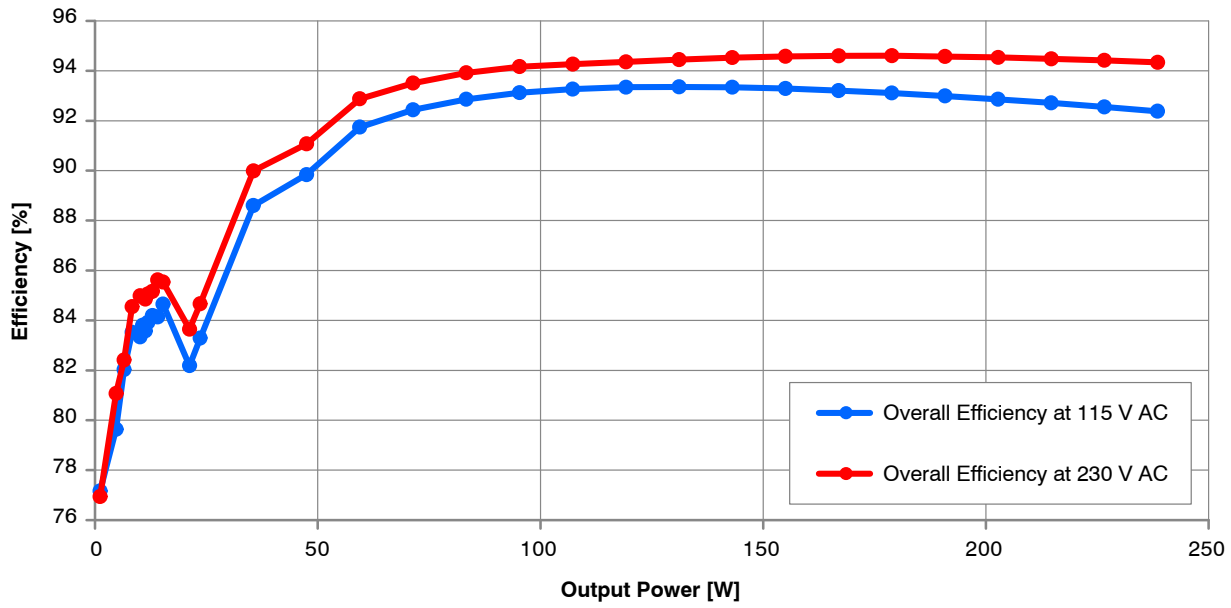

Figure 12. Overall Efficiency vs. Output Power

Table 2. EFFICIENCY DATA MEASURED AND AVERAGED FROM 10 BUILT DEMO_BOARDS

LOAD	Consumption [mW] of Efficiency [%]	
	@ 120 V _{AC}	@ 230 V _{AC}
NO-LOAD	< 115 mW	< 125 mW
Load 250 mW	0,466	0,475
Load 500 mW	0,72	0,823
Load 20% – 4 A	90,22	91,47
Load 25% – 5 A	91,82	92,95
Load 50% – 10 A	93,39	94,36
Load 75% – 15 A	93,13	94,62
Load 100% – 20 A	92,57	94,5
4 point AVG	92,73	94,11

EVBUM2566/D

The following figures illustrate conducted EMI signatures under full loading for different input line voltage levels.

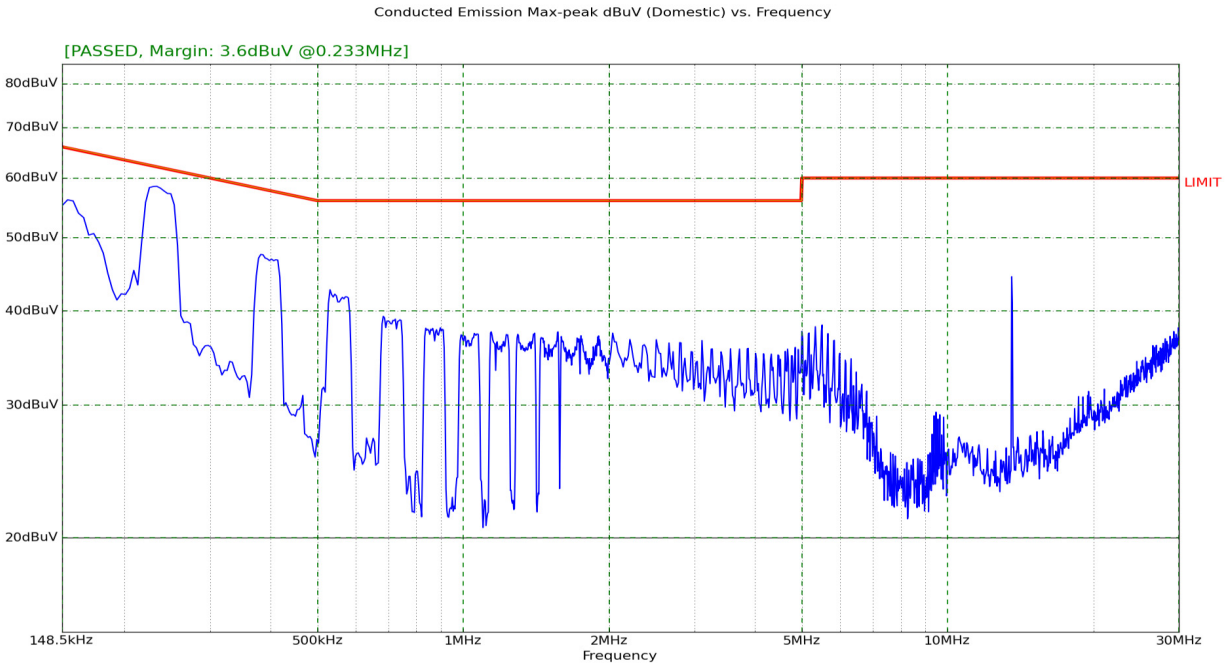

Figure 13. EMI Signature Comparison @ 120 V_{AC} & Full-load (Measured MAX Peak)

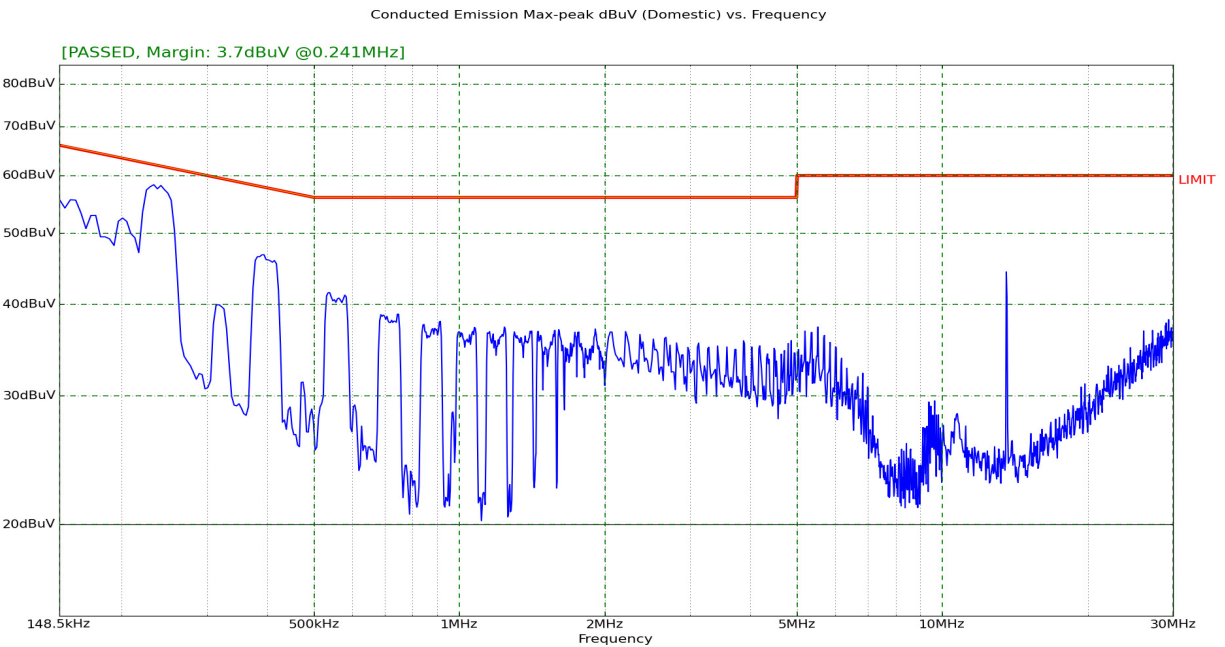

Figure 14. EMI Signature Comparison @ 230 V_{AC} & Full-load (Measured MAX Peak)

Figures 15 to 16 are focused on transient response, which is highly depended (when is expected correct feedback loop behavior) on loading current slope and output optional post filter composed of L4 and C12. In case, that higher current slope and lower voltage drop are needed inductor L4 can be

replaced by new one with lower inductance. Figure 17 show power supply input current shape for different input line voltage levels under full loading. Figures 18–20 are intended to LLC stage operation.

EVBUM2566/D



CH1 – LLC Low Side MOSFET Gate-Drive Voltage CH2 – Output Voltage CH3 – LLC HB Node Voltage CH4 – Loading current

Figure 15. Step Load Response 20 A to 2 A – 50 A/s (Right Measured without Post Inductor)

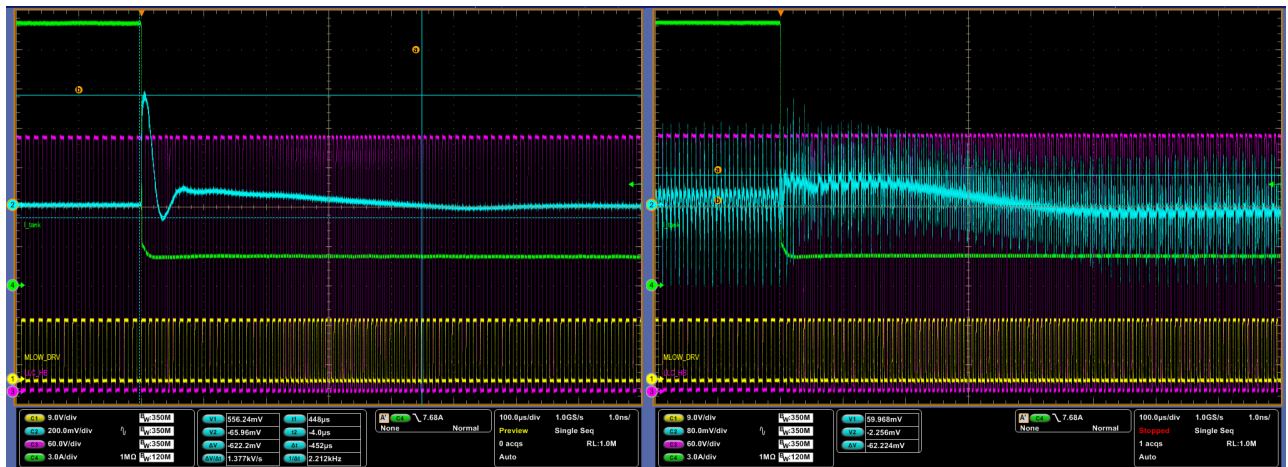

CH1 – LLC Low Side MOSFET Gate-Drive Voltage CH2 – Output Voltage CH3 – LLC HB Node Voltage CH4 – Loading current

Figure 16. Step Load Response 20 A to 2 A – 50 A/s (Right Measured without Post Inductor)

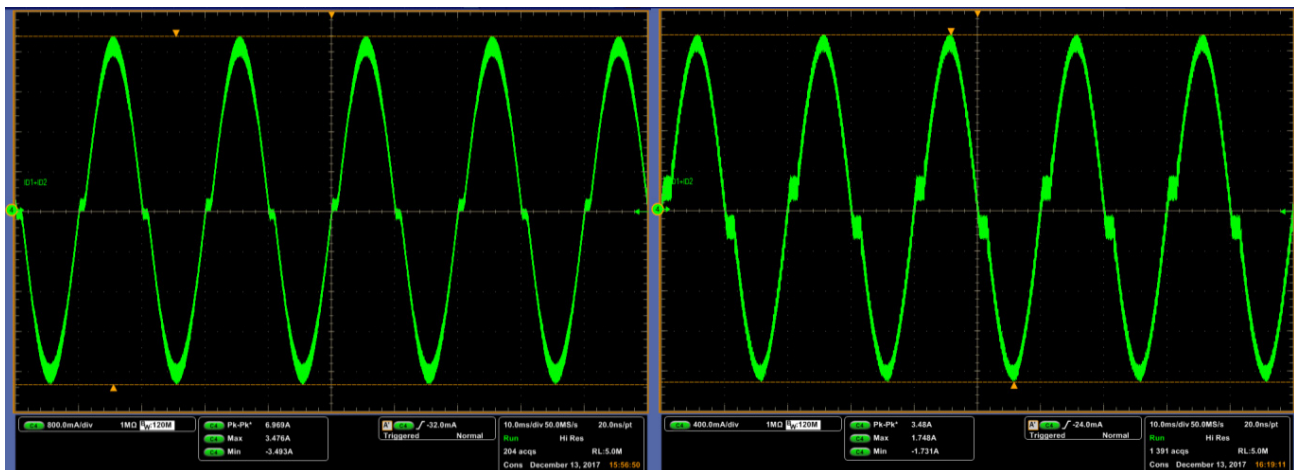

CH1 – N/A CH2 – N/A CH3 – N/A CH4 – Input line current

Figure 17. PFC Input Current @ 240 W Load @ 115 V_{AC} – Left, @ 230 V_{AC} Right



CH1 – LLC Low Side MOSFET Gate-Drive Voltage CH2 – N/A CH3 – LLC HB Node Voltage CH4 – Resonant tank current

Figure 18. LLC Stage Start-up Sequence into Full-load Detail – Left, LCC Stage NO-LOAD Burst Detail – Right

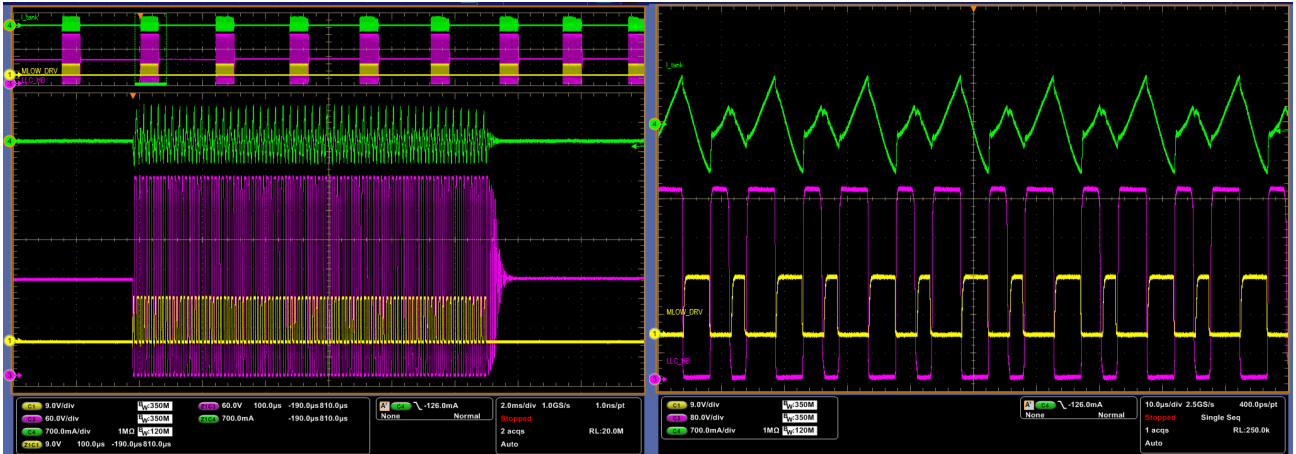

CH1 – LLC Low Side MOSFET Gate-Drive Voltage CH2 – N/A CH3 – LLC HB Node Voltage CH4 – Resonant tank current

Figure 19. LLC Stage SKIP Mode Operation at 0.5 A Load (Burst Detail) – Left, Light-load Mode Operation at 2 A Load – Right

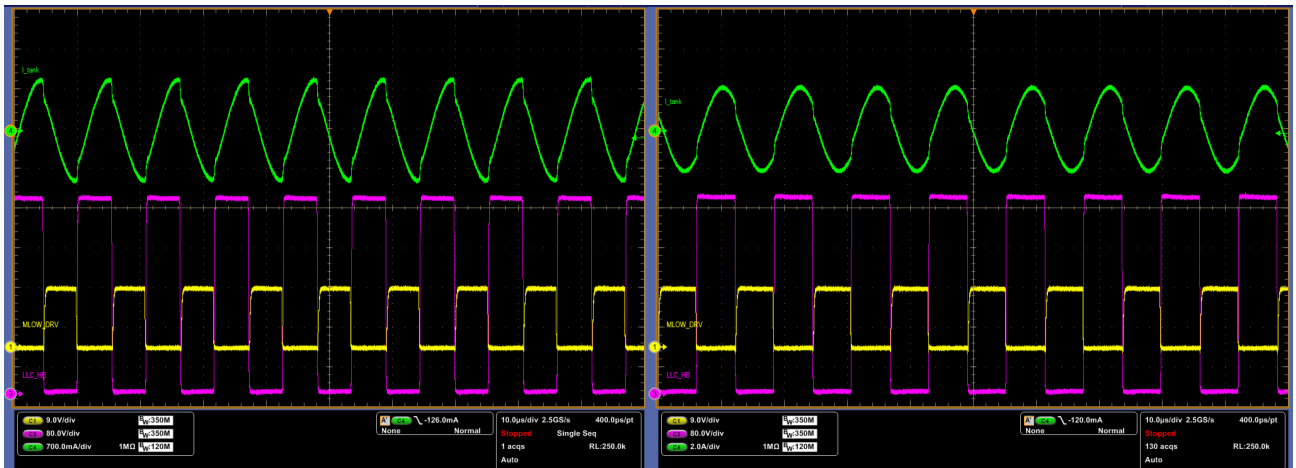

CH1 – LLC Low Side MOSFET Gate-Drive Voltage CH2 – N/A CH3 – LLC HB Node Voltage CH4 – Resonant tank current

Figure 20. LLC Stage Normal Operation 10 A Load – Left, LLC Stage Normal Operation 20 A Load – Right

EVBUM2566/D



CH1 – PFC MOSFET Gate-Drive Voltage

CH2 – Bulk Voltage

CH3 – PFC MOSFET Drain Voltage

CH4 – PFC inductor current

Figure 21. PFC V_{bulk} Building @ 230 V_{AC} @ 20 A Load – Left, PFC SKIP MODE at 0.5 A Load (Burst Detail) – Right

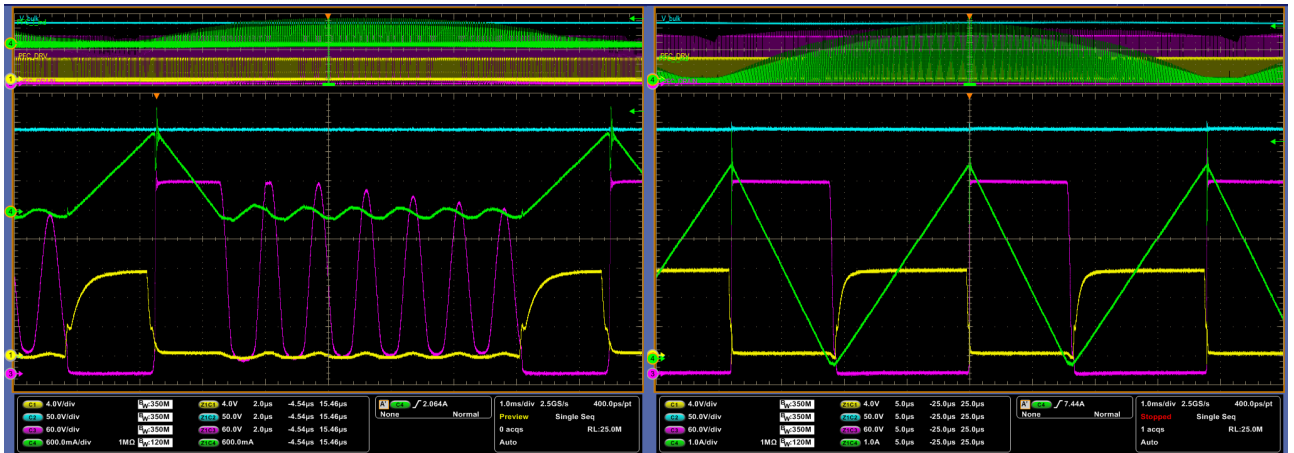

CH1 – PFC MOSFET Gate-Drive Voltage

CH2 – Bulk Voltage

CH3 – PFC MOSFET Drain Voltage

CH4 – PFC inductor current

Figure 22. PFC, DCM @ 120 V_{AC} 1.5 A Load – Left, PFC, CrM @ 120 V_{AC} 20 A Load – Right

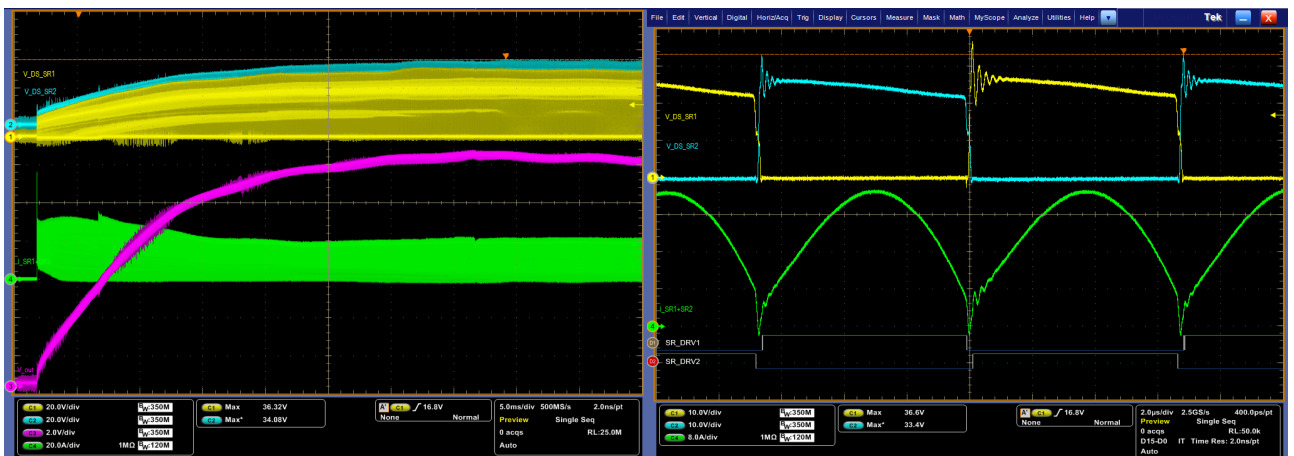

CH1 – PFC MOSFET Gate-Drive Voltage

CH2 – Bulk Voltage

CH3 – PFC MOSFET Drain Voltage

CH4 – PFC inductor current

Figure 23. SR Waveforms during V_{OUT} Building into Full Load – Left, SR NORMAL MODE @ Load 20 A – Right

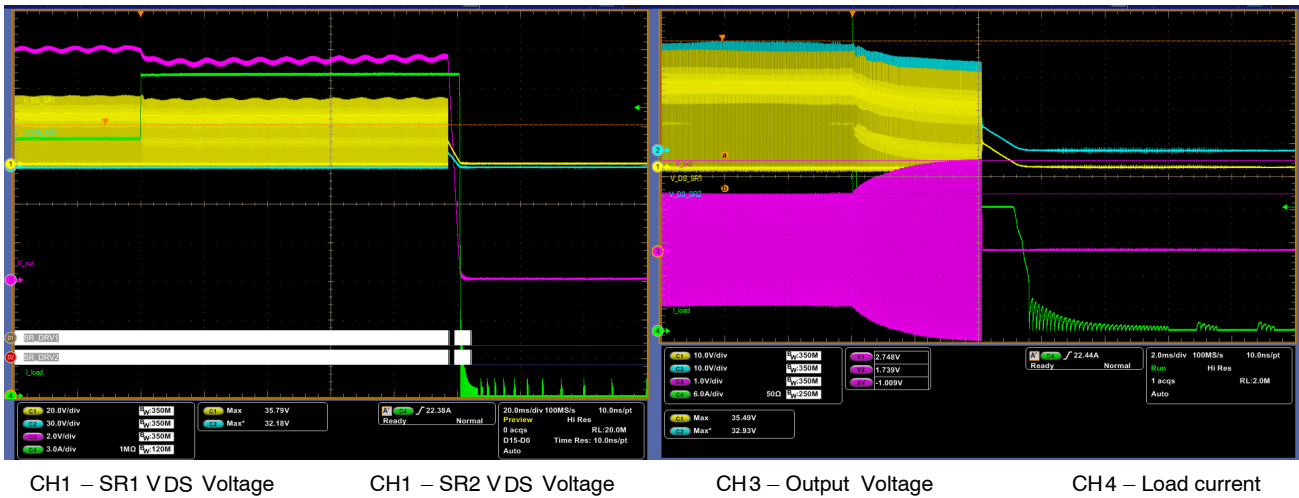

Figure 24. SR Waveforms during Overload from 20 A to 25 A (FB Fault 100 ms) – Left, SR Waveforms during Hard Overload from 20 A to 50 A (CS Stop) – Right

Literature

- High Performance Current Mode Resonant Controller with Integrated High Voltage Drivers: NCP13992: <http://www.onsemi.com/PowerSolutions/product.do?id=NCP13992>
- Power Factor Controller, High Voltage Active X2: NCP1616: <http://www.onsemi.com/PowerSolutions/product.do?id=NCP1616>
- Secondary Side Synchronous Rectifier Controllers: NCP4306: <http://www.onsemi.com/PowerSolutions/product.do?id=NCP4306>
- Voltage Reference, Programmable Shunt Regulator: NCP431: <http://www.onsemi.com/PowerSolutions/product.do?id=NCP431>
- N-Channel SupreMOS[®] MOSFET 600 V, 22 A, 165 mΩ FCPF22N60NT: <http://www.onsemi.com/PowerSolutions/product.do?id=FCPF22N60NT>
- Power Rectifier, Soft Recovery, Switch-mode, 8 A, 600 V MSR860: <http://www.onsemi.com/PowerSolutions/product.do?id=MSRF860G>
- N-Channel SupreMOS[®] MOSFET 600 V, 13 A, 258 mΩ FCPF13N60NT: <http://www.onsemi.com/PowerSolutions/product.do?id=FCPF13N60NT>
- Single N-Channel Power MOSFET 40 V, 130 A, 2.5 mΩ NVMF55C442NL: <http://www.onsemi.com/PowerSolutions/product.do?id=NVMF55C442NL>

EVBUM2566/D

Table 3. BILL OF MATERIALS

Reference	Qty.	Description	Value	Footprint	Manufacturer	Manufacturer Part Number	Substitution
B1	1	Bridge Rectifier	KBU8M	Through Hole	Vishay	KBU8M-E4/51	Yes
C12	1	Electrolytic Capacitor	220 μ F/25 V	Through Hole	Panasonic	EEU0FC1E221	Yes
C13, C31, C62	3	Ceramic Capacitor	1 nF/50 V	C 0805	Various		
C15, C33, C47	3	MKP Capacitor	1 μ F/275 Vac	Through Hole	Würth Elektronik	MXXP225105K310ASP 46000	Yes
C16, C38, C55	3	Electrolytic Capacitor	100 μ F/450 V	Through Hole	Rubycon	450BXW100MEFC18X30	Yes
C17, C29	2	Ceramic Capacitor	220 pF/1 kV	Through Hole	Vishay	S221M39SL0N63K7R	Yes
C2, C26, C27, C30, C34, C57	6	Ceramic Capacitor	10 nF/50 V	C 0805	Various	-	Yes
C3	1	Electrolytic Capacitor	220 μ F/35 V	Through Hole	Panasonic	EEU0FM1V221L	Yes
C32	1	Ceramic Capacitor	39 nF/50 V	C 0805	Various	-	Yes
C36	1	Ceramic Capacitor	2.2 μ F/16 V	C 0805	Various	-	Yes
C37	1	Electrolytic Capacitor	100 μ F/25 V	Through Hole	Panasonic	EEU-TA1E101BJ	Yes
C4, C25	2	Ceramic Capacitor	6.8 pF/50 V	1206	Various	-	Yes
C40	1	Ceramic Capacitor	820 nF/16 V	C 0805	Various	-	Yes
C44	1	Ceramic Capacitor	100 pF/50 V	C 0805	Various	-	Yes
C5, C19, C41, C43, C53, C54, C59, C63, C71, C73	10	Ceramic Capacitor	100 nF/50 V	C 0805	Various	-	Yes
C50	1	Ceramic Capacitor	470 pF/50 V	C 0805	Various	-	Yes
C51	1	Ceramic Capacitor	27 nF/50 V	C 0805	Various	-	Yes
C56	1	Electrolytic Capacitor	220 μ F/35 V	Through Hole	Panasonic	EEU0FM1V221L	Yes
C6, C20	2	Ceramic Capacitor	1 μ F/25 V	C 0805	Various	-	Yes
C66	1	Ceramic Capacitor	220 nF/16 V	C 0805	Various	-	Yes
C7, C18	2	Metal Film Capacitor	33 nF/630 V	Through Hole	Epcos	B32652A6333J	Yes
C8, C9, C10, C11, C21, C22, C23, C24	8	Electrolytic Capacitor	1000 μ F/16 V	Through Hole	Panasonic	P15332CT0ND	Yes
CY1, CY2, CY3	3	Y Capacitor	22 nF/Y1	Through Hole	Murata	DE1E3KX222MA5BA01	
D1, D7, D8, D14, D17	5	Diode	MMSD4148	SOD123	ON Semiconductor	MMSD4148T3G	No
D12, D13	2	Schottky Diode	MBR0540	SOD123	ON Semiconductor	MBR0540T1G	No
D19, D26	2	Schottky Diode	BAT54	SOD123	ON Semiconductor	BAT54T1G	No
D2	1	Zener Diode	15 V	SOD123	ON Semiconductor	MMSZ15T1G	No
D21	1	Zener Diode	4.3 V	SOD123	ON Semiconductor	MMSZ4V3T1G	No
D22, D28	2	Power Rectifier Diode	MRA4007T3G	SMA	ON Semiconductor	MRA4007T3G	No
D23	1	Ultrafast Power Rectifier Diode	MURA160	SMA	ON Semiconductor	MURA160T3G	No
D3	1	Schottky Diode	MBR2H100	SOD123	ON Semiconductor	MBR2H100SFT3G	No
D4	1	Standard Recovery Rectifier Diode	1N5408	Through Hole	ON Semiconductor	1N5408RLG	No
D5	1	Soft Recovery Rectifier Diode	MSR860	TO220	ON Semiconductor	MSRF860G	No
D6, D9	2	Diode	NU	-	-	-	-
F1	1	FUSE HOLDER + 4A/T Fuse	T-4A	Through Hole	Various	-	Yes
IC3	1	LLC Controller	NCP13992	NCP1399	ON Semiconductor	NCP13992AIOGEVB	No
IC4, IC5	2	Synchronous Rectifier Controller	NCP4306	SOIC8	ON Semiconductor	NCP4306AAZZZA	No
IC6, IC7	2	Shunt Regulator	NCP431	SOT23	ON Semiconductor	NCP431AVSNT1G	No
L1	1	Power Resonant Inductor	50 μ H	RM8	Würth Elektronik	750370249	Yes
L15	1	Common Mode Inductor	2.9 mH	Through Hole	ICE Components	LF-28030-0029-H	No
L2	1	PFC Inductor	260 μ H	PQ3225	Würth Elektronik	750315036	Yes

EVBUM2566/D

Table 3. BILL OF MATERIALS (continued)

Reference	Qty.	Description	Value	Footprint	Manufacturer	Manufacturer Part Number	Substitution
L4	1	High Current Inductor	300 nH/30 A	Through Hole	Würth Elektronik	WW006	Yes
L5, L6	2	EMI Inductor	90 μ H	Through Hole	Würth Elektronik	7447013	Yes
NTC1	1	NTC Thermistor	330 k Ω	Through Hole	Vishay	NTCLE100E3334JB0	Yes
OK1, OK3	2	Optocoupler	FOD817B	Through Hole	ON Semiconductor	FOD817B	No
Q2, Q9, Q20, Q21	4	N-channel MOSFET	NTMFS5C442	SO-8FL/DFN-5	ON Semiconductor	NTMFS5C442NLT1G	No
Q3, Q5	2	N-channel MOSFET	FCPF13N60	TO220	ON Semiconductor	FCPF13N60NT	No
Q4	1	N-channel MOSFET	FCPF22N60	TO220	ON Semiconductor	FCPF22N60NT	No
Q6	1	N-channel MOSFET	BSS138	SOT23	ON Semiconductor	BSS138LT1G	Yes
Q7	1	PNP Transistor	BC807-16	SOT23	ON Semiconductor	BC807-16LT1G	Yes
Q8	1	N-channel MOSFET	BSS138	SOT23	ON Semiconductor	BSS138LT1G	Yes
R1, R99	2	Resistor	150 k Ω	R 0805	Various	-	Yes
R10, R32	2	Resistor	4.7 Ω /5%	R 0805	Various	-	Yes
R100, R101, R105	3	Resistor	27 k Ω	R 0805	Various	-	Yes
R102	1	Resistor	330 k Ω	R 0805	Various	-	Yes
R107	1	Resistor	47 M Ω /5%	Through Hole	Vishay	VR37000004704JA100	Yes
R11, R39, R104	3	Resistor	5.6 k Ω	R 0805	Various	-	Yes
R126	1	Resistor	5.1 k Ω	R 0805	Various	-	Yes
R137	1	Resistor	75 k Ω	R 0805	Various	-	Yes
R148	1	Resistor	1.5 k Ω	R 0805	Various	-	Yes
R150	1	Resistor	2 Ω /5%	R 0805	Various	-	Yes
R18, R27	2	Resistor	1.8 M Ω	R 0805	Various	-	Yes
R2, R158	2	Resistor	86 k Ω	R 0805	Various	-	Yes
R24, R84	2	Resistor	1 k Ω	R 0805	Various	-	Yes
R25	1	Resistor	47 Ω /5%	R 0805	Various	-	Yes
R26, R54, R55	3	Resistor	22 Ω /5%	R 0805	Various	-	Yes
R28	1	Resistor	33 k Ω	R 0805	Various	-	Yes
R3, R5, R13, R16, R30, R34, R43, R50, R56, R57, R61, R69, R72, R78, R94, R140, R142, R147	18	Resistor	0 Ω	R 0805	Various	-	Yes
R31	1	Resistor	1 M Ω	R 0805	Various	-	Yes
R35, R47	2	Resistor	1.6 M Ω	R 0805	Various	-	Yes
R38	1	Resistor	0.05 Ω /3 W	Through Hole	Vishay/ Dale	LVR03R0500FR50	Yes
R4, R12, R20, R33, R36, R51	6	Resistor	22 k Ω	R 0805	Various	-	Yes
R42, R52, R68	3	Resistor	0 Ω	R 1206	Various	-	Yes
R48	1	VARISTOR	275 V _{AC}	Through Hole	Würth Elektronik	820512711	Yes
R49	1	Resistor	680 k Ω	R 0805	Various	-	Yes
R58, R62	2	Resistor	1 Ω /5%	R 0805	Various	-	Yes
R6, R15, R87, R92	4	Resistor	2.7 k Ω	R 1206	Various	-	Yes
R63	1	Resistor	2 k Ω	R 0805	Various	-	Yes
R64	1	Resistor	100 Ω	R 0805	Various	-	Yes
R66	1	Resistor	4.7 k Ω	R 0805	Various	-	Yes
R67	1	Resistor	13 k Ω	R 0805	Various	-	Yes
R7, R37	2	Resistor	36 k Ω	R 0805	Various	-	Yes
R70, R133	2	Resistor	20 k Ω	R 0805	Various	-	Yes
R74, R76, R95	3	Resistor	47 k Ω	R 0805	Various	-	Yes
R75	1	Resistor	30 k Ω	R 0805	Various	-	Yes
R77	1	Resistor	12 k Ω	R 0805	Various	-	Yes

Table 3. BILL OF MATERIALS (continued)

Reference	Qty.	Description	Value	Footprint	Manufacturer	Manufacturer Part Number	Substitution
R79	1	Resistor	82 kΩ	R 0805	Various	-	Yes
R8, R9, R40, R41	4	Resistor	56 Ω/5%	R 1206	Various	-	Yes
R80	1	Resistor	200 kΩ	R 0805	Various	-	Yes
R82, R88	2	Resistor	68 kΩ	R 0805	Various	-	Yes
R85	1	Resistor	820 Ω	R 0805	Various	-	Yes
R89	1	Resistor	39 kΩ	R 0805	Various	-	Yes
R91	1	VARISTOR	strap	-	-	-	Yes
R96	1	Resistor	5.6 /5%	R 0805	Various	-	Yes
R98	1	Resistor	11 kΩ	R 0805	Various	-	Yes
TR1	1	LLC Transformer	Lpri = 600 μH	PQ3225	Würth Elektronik	750314580	Yes
U1	1	Power Factor Controller	NCP1616A1	SO9	ON Semiconductor	NCP1616A1	No
X1	1	Wire to board terminal	Pitch 5 mm	Through Hole	IMO	20.700M/2	Yes
X2	1	Wire to board terminal	Pitch 5 mm	Through Hole	Lumberg	KRE 02	Yes

ON Semiconductor and  are trademarks of Semiconductor Components Industries, LLC dba ON Semiconductor or its subsidiaries in the United States and/or other countries. ON Semiconductor owns the rights to a number of patents, trademarks, copyrights, trade secrets, and other intellectual property. A listing of ON Semiconductor's product/patent coverage may be accessed at www.onsemi.com/site/pdf/Patent-Marking.pdf. ON Semiconductor reserves the right to make changes without further notice to any products herein. ON Semiconductor makes no warranty, representation or guarantee regarding the suitability of its products for any particular purpose, nor does ON Semiconductor assume any liability arising out of the application or use of any product or circuit, and specifically disclaims any and all liability, including without limitation special, consequential or incidental damages. Buyer is responsible for its products and applications using ON Semiconductor products, including compliance with all laws, regulations and safety requirements or standards, regardless of any support or applications information provided by ON Semiconductor. "Typical" parameters which may be provided in ON Semiconductor data sheets and/or specifications can and do vary in different applications and actual performance may vary over time. All operating parameters, including "Typicals" must be validated for each customer application by customer's technical experts. ON Semiconductor does not convey any license under its patent rights nor the rights of others. ON Semiconductor products are not designed, intended, or authorized for use as a critical component in life support systems or any FDA Class 3 medical devices or medical devices with a same or similar classification in a foreign jurisdiction or any devices intended for implantation in the human body. Should Buyer purchase or use ON Semiconductor products for any such unintended or unauthorized application, Buyer shall indemnify and hold ON Semiconductor and its officers, employees, subsidiaries, affiliates, and distributors harmless against all claims, costs, damages, and expenses, and reasonable attorney fees arising out of, directly or indirectly, any claim of personal injury or death associated with such unintended or unauthorized use, even if such claim alleges that ON Semiconductor was negligent regarding the design or manufacture of the part. ON Semiconductor is an Equal Opportunity/Affirmative Action Employer. This literature is subject to all applicable copyright laws and is not for resale in any manner.

PUBLICATION ORDERING INFORMATION

LITERATURE FULFILLMENT:
 Literature Distribution Center for ON Semiconductor
 19521 E. 32nd Pkwy, Aurora, Colorado 80011 USA
Phone: 303-675-2175 or 800-344-3860 Toll Free USA/Canada
Fax: 303-675-2176 or 800-344-3867 Toll Free USA/Canada
Email: orderlit@onsemi.com

N. American Technical Support: 800-282-9855 Toll Free USA/Canada
Europe, Middle East and Africa Technical Support: Phone: 421 33 790 2910

ON Semiconductor Website: www.onsemi.com
Order Literature: <http://www.onsemi.com/orderlit>
 For additional information, please contact your local Sales Representative