



Main

Range of product	OsiSense XS
Series name	General purpose
Sensor type	Inductive proximity sensor
Device application	-
Sensor name	XS6
Sensor design	Cylindrical M30
Size	62 mm
Body type	Fixed
Detector flush mounting acceptance	Flush mountable
Material	Metal
Type of output signal	Discrete
Wiring technique	2-wire
[Sn] nominal sensing distance	15 mm
Discrete output function	1 NO
Output circuit type	AC/DC
Electrical connection	Cable
Cable length	10 m
[Us] rated supply voltage	24...240 V AC/DC (50/60 Hz)
Switching capacity in mA	5...200 mA DC 5...300 mA AC
IP degree of protection	IP68 double insulation conforming to IEC 60529 IP69K conforming to DIN 40050

Complementary

Thread type	M30 x 1.5
Detection face	Frontal
Front material	PPS
Enclosure material	Nickel plated brass

Operating zone	0...12 mm
Differential travel	1...15% of Sr
Cable composition	2 x 0.34 mm ²
Wire insulation material	PvR
Status LED	1 LED (yellow) for output state
Supply voltage limits	20...264 V AC/DC
Residual current	<= 0.8 mA, open state
Switching frequency	<= 25 Hz AC <= 500 Hz DC
Voltage drop	<= 5.5 V, closed state
Delay first up	<= 25 ms
Delay response	<= 0.5 ms
Delay recovery	<= 2 ms
Marking	CE
Threaded length	52 mm
Length	62 mm
Product weight	0.525 kg

Environment

Product certifications	CSA UL
Ambient air temperature for operation	-25...70 °C
Ambient air temperature for storage	-40...85 °C
Vibration resistance	25 gn, amplitude: +/- 2 mm (f = 10...55 Hz) conforming to IEC 60068-2-6
Shock resistance	50 gn (duration = 11 ms) conforming to IEC 60068-2-27

Offer Sustainability

Sustainable offer status	Green Premium product
RoHS (date code: YYWW)	Compliant - since 0811 - Schneider Electric declaration of conformity Schneider Electric declaration of conformity
REACH	Reference not containing SVHC above the threshold Reference not containing SVHC above the threshold
Product environmental profile	Available End of Life Information
Product end of life instructions	Available

Contractual warranty

Warranty period	18 months
-----------------	-----------

Dimensions

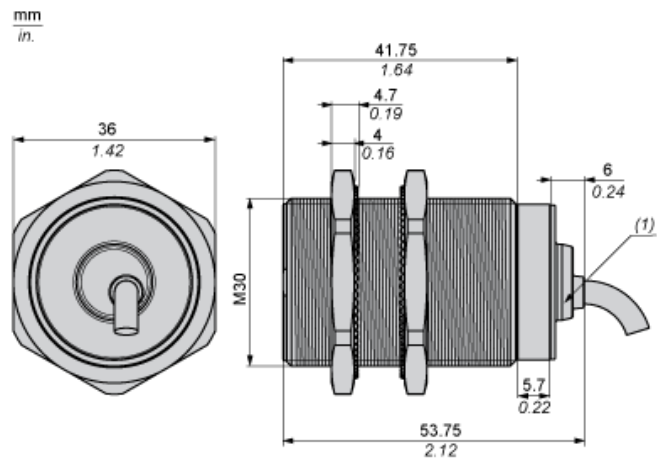

(1) LED

Minimum Mounting Distances

Side by side



$e (1) \geq 30 \text{ mm}/1.18 \text{ in.}$

Face to face



$e (2) \geq 180 \text{ mm}/7.09 \text{ in.}$

Facing a metal object



$e (3) \geq 45 \text{ mm}/1.77 \text{ in.}$

Wiring Schemes

2-Wire AC or DC

NO output

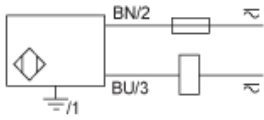

BU : Blue
BN : Brown