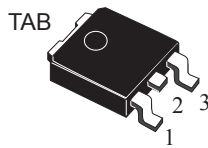
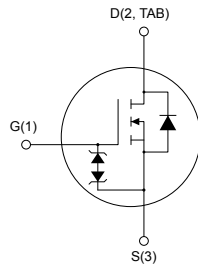

## N-channel 600 V, 0.550 $\Omega$ typ., 7.5 A MDmesh™ M2 EP Power MOSFET in a DPAK package

**DPAK**

AM01479V1

### Features

Order code	$V_{DS}$	$R_{DS(on)}$ max.	$I_D$
STD11N60M2-EP	600 V	0.595 $\Omega$	7.5 A

- Extremely low gate charge
- Excellent output capacitance ( $C_{OSS}$ ) profile
- Very low turn-off switching losses
- 100% avalanche tested
- Zener-protected

### Applications

- Switching applications

### Description

This device is an N-channel Power MOSFET developed using MDmesh™ M2 enhanced performance (EP) technology. Thanks to its strip layout and an improved vertical structure, the device exhibits low on-resistance, optimized switching characteristics with very low turn-off switching losses, rendering it suitable for the most demanding very high frequency converters.

#### Product status

STD11N60M2-EP

#### Product summary

<b>Order code</b>	STD11N60M2-EP
<b>Marking</b>	11N60M2EP
<b>Package</b>	DPAK
<b>Packing</b>	Tape and Reel

# 1 Electrical ratings

**Table 1. Absolute maximum ratings**

Symbol	Parameter	Value	Unit
$V_{GS}$	Gate-source voltage	$\pm 25$	V
$I_D$	Drain current (continuous) at $T_C = 25\text{ }^\circ\text{C}$	7.5	A
$I_D$	Drain current (continuous) at $T_C = 100\text{ }^\circ\text{C}$	4.7	A
$I_{DM}^{(1)}$	Drain current (pulsed)	30	A
$P_{TOT}$	Total dissipation at $T_C = 25\text{ }^\circ\text{C}$	85	W
$dv/dt^{(2)}$	Peak diode recovery voltage slope	15	V/ns
$dv/dt^{(3)}$	MOSFET $dv/dt$ ruggedness	50	V/ns
$T_{stg}$	Storage temperature range	- 55 to 150	$^\circ\text{C}$
$T_j$	Operating junction temperature range		

1. Pulse width limited by safe operating area.
2.  $I_{SD} \leq 7.5\text{ A}$ ,  $di/dt \leq 400\text{ A}/\mu\text{s}$ ;  $V_{DS\ peak} < V_{(BR)DSS}$ ,  $V_{DD} = 400\text{ V}$ .
3.  $V_{DS} \leq 480\text{ V}$

**Table 2. Thermal data**

Symbol	Parameter	Value	Unit
$R_{thj-case}$	Thermal resistance junction-case	1.47	$^\circ\text{C}/\text{W}$
$R_{thj-pcb}^{(1)}$	Thermal resistance junction-pcb	50	$^\circ\text{C}/\text{W}$

1. When mounted on FR-4 board of 1 inch<sup>2</sup>, 2 oz Cu

**Table 3. Avalanche characteristics**

Symbol	Parameter	Value	Unit
$I_{AR}$	Avalanche current, repetitive or not repetitive (pulse width limited by $T_{jmax}$ )	2.4	A
$E_{AS}$	Single pulse avalanche energy (starting $T_j = 25\text{ }^\circ\text{C}$ , $I_D = I_{AR}$ ; $V_{DD} = 50\text{ V}$ )	115	mJ

## 2 Electrical characteristics

$T_C = 25\text{ }^\circ\text{C}$  unless otherwise specified

**Table 4. On/off states**

Symbol	Parameter	Test conditions	Min.	Typ.	Max.	Unit
$V_{(BR)DSS}$	Drain-source breakdown voltage	$V_{GS} = 0\text{ V}, I_D = 1\text{ mA}$	600			V
$I_{DSS}$	Zero gate voltage drain current	$V_{GS} = 0\text{ V}, V_{DS} = 600\text{ V}$			1	$\mu\text{A}$
		$V_{GS} = 0\text{ V}, V_{DS} = 600\text{ V}, T_C = 125\text{ }^\circ\text{C}^{(1)}$			100	$\mu\text{A}$
$I_{GSS}$	Gate-body leakage current	$V_{DS} = 0\text{ V}, V_{GS} = \pm 25\text{ V}$			$\pm 10$	$\mu\text{A}$
$V_{GS(th)}$	Gate threshold voltage	$V_{DS} = V_{GS}, I_D = 250\text{ }\mu\text{A}$	3.25	4	4.75	V
$R_{DS(on)}$	Static drain-source on-resistance	$V_{GS} = 10\text{ V}, I_D = 3.75\text{ A}$		0.550	0.595	$\Omega$

1. Defined by design, not subject to production test.

**Table 5. Dynamic**

Symbol	Parameter	Test conditions	Min.	Typ.	Max.	Unit
$C_{iss}$	Input capacitance	$V_{DS} = 100\text{ V}, f = 1\text{ MHz}, V_{GS} = 0\text{ V}$	-	390	-	pF
$C_{oss}$	Output capacitance		-	22	-	pF
$C_{rSS}$	Reverse transfer capacitance		-	0.7	-	pF
$C_{oss\text{ eq.}}^{(1)}$	Equivalent output capacitance	$V_{DS} = 0\text{ to }480\text{ V}, V_{GS} = 0\text{ V}$	-	49	-	pF
$R_G$	Intrinsic gate resistance	$f = 1\text{ MHz}, I_D = 0\text{ A}$	-	9	-	$\Omega$
$Q_g$	Total gate charge	$V_{DD} = 480\text{ V}, I_D = 7.5\text{ A}, V_{GS} = 0\text{ to }10\text{ V}$ (see Figure 15. Test circuit for gate charge behavior)	-	12.4	-	nC
$Q_{gs}$	Gate-source charge		-	2.1	-	nC
$Q_{gd}$	Gate-drain charge		-	6	-	nC

1.  $C_{oss\text{ eq.}}$  is defined as a constant equivalent capacitance giving the same charging time as  $C_{oss}$  when  $V_{DS}$  increases from 0 to 80%  $V_{DSS}$

**Table 6. Switching energy**

Symbol	Parameter	Test conditions	Min.	Typ.	Max.	Unit
$E_{(off)}$	Turn-off energy (from 90% $V_{GS}$ to 0% $I_D$ )	$V_{DD} = 400\text{ V}, I_D = 1\text{ A}, R_G = 4.7\text{ }\Omega, V_{GS} = 10\text{ V}$	-	2.5	-	$\mu\text{J}$
		$V_{DD} = 400\text{ V}, I_D = 3\text{ A}, R_G = 4.7\text{ }\Omega, V_{GS} = 10\text{ V}$	-	9	-	$\mu\text{J}$

**Table 7. Switching times**

Symbol	Parameter	Test conditions	Min.	Typ.	Max.	Unit
$t_{d(on)}$	Turn-on delay time	$V_{DD} = 300\text{ V}$ , $I_D = 3.75\text{ A}$ , $R_G = 4.7\ \Omega$ , $V_{GS} = 10\text{ V}$ (see Figure 14. Test circuit for resistive load switching times and Figure 19. Switching time waveform)	-	9	-	ns
$t_r$	Rise time		-	5.5	-	ns
$t_{d(off)}$	Turn-off-delay time		-	26	-	ns
$t_f$	Fall time		-	8	-	ns

**Table 8. Source drain diode**

Symbol	Parameter	Test conditions	Min.	Typ.	Max.	Unit
$I_{SD}$	Source-drain current		-		7.5	A
$I_{SDM}^{(1)}$	Source-drain current (pulsed)		-		30	A
$V_{SD}^{(2)}$	Forward on voltage	$V_{GS} = 0\text{ V}$ , $I_{SD} = 7.5\text{ A}$	-		1.6	V
$t_{rr}$	Reverse recovery time	$I_{SD} = 7.5\text{ A}$ , $di/dt = 100\text{ A}/\mu\text{s}$ , $V_{DD} = 60\text{ V}$ (see Figure 16. Test circuit for inductive load switching and diode recovery times)	-	192		ns
$Q_{rr}$	Reverse recovery charge		-	1.32		$\mu\text{C}$
$I_{RRM}$	Reverse recovery current		-	13.8		A
$t_{rr}$	Reverse recovery time	$I_{SD} = 7.5\text{ A}$ , $di/dt = 100\text{ A}/\mu\text{s}$ , $V_{DD} = 60\text{ V}$ , $T_j = 150\text{ }^\circ\text{C}$ (see Figure 16. Test circuit for inductive load switching and diode recovery times)	-	262		ns
$Q_{rr}$	Reverse recovery charge		-	1.74		$\mu\text{C}$
$I_{RRM}$	Reverse recovery current		-	13.3		A

1. Pulse width is limited by safe operating area
2. Pulsed: pulse duration = 300  $\mu\text{s}$ , duty cycle 1.5%

## 2.1 Electrical characteristics (curves)

Figure 1. Safe operating area

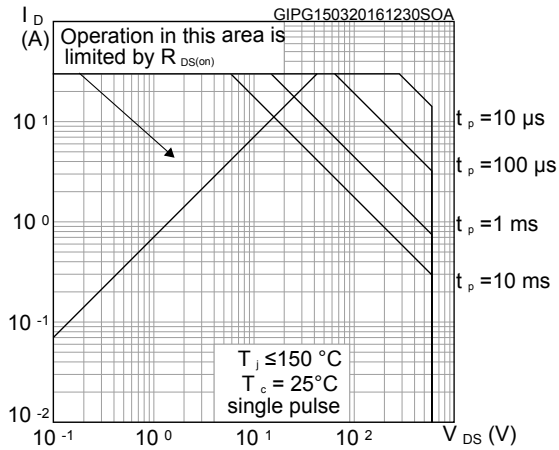

Figure 2. Thermal impedance

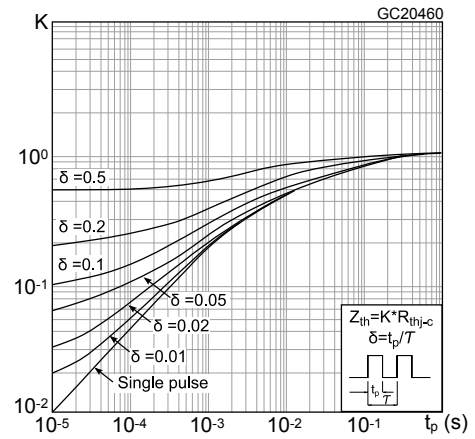

Figure 3. Output characteristics

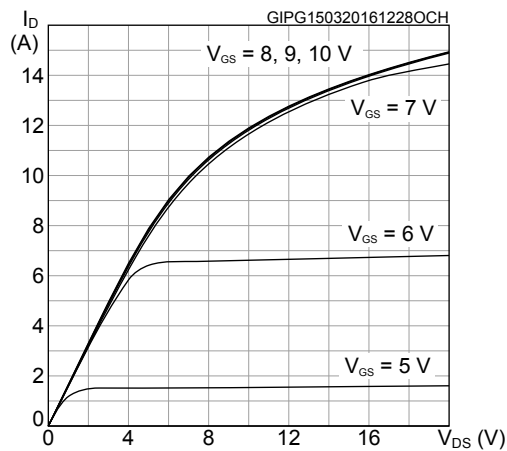
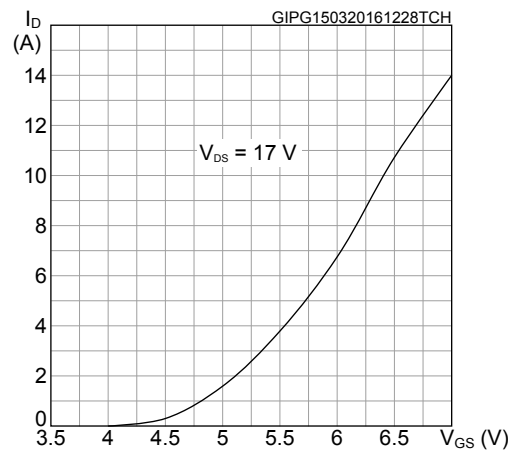
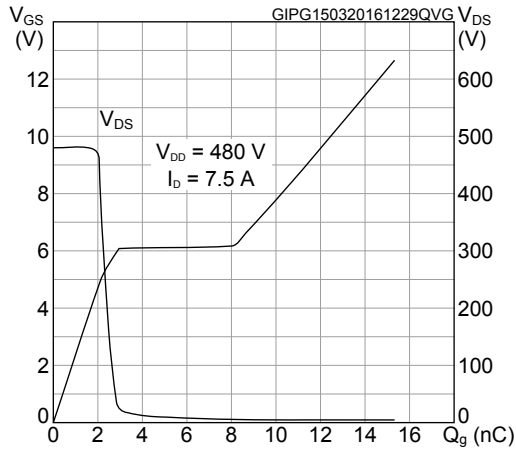

Figure 4. Transfer characteristics



**Figure 5. Gate charge vs gate-source voltage**



**Figure 6. Static drain-source on-resistance**

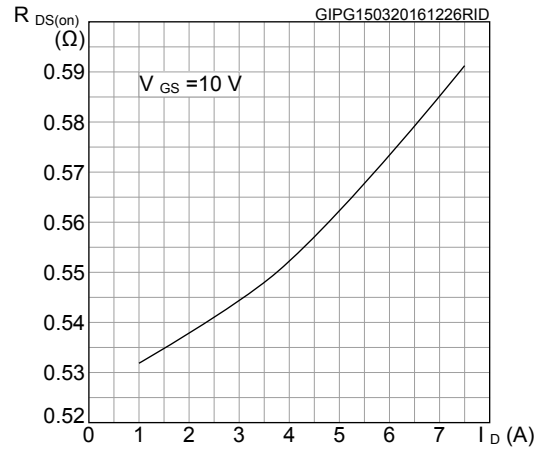

**Figure 7. Capacitance variations**

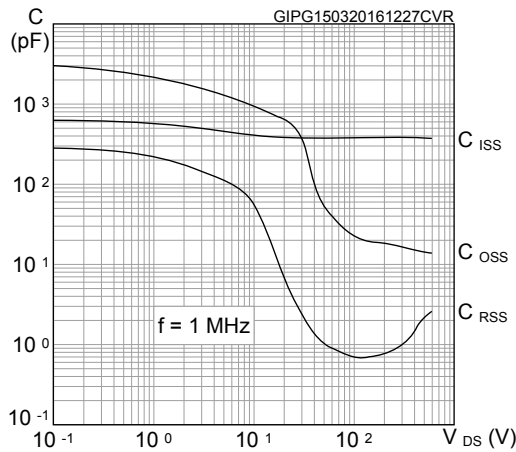

**Figure 8. Turn-off switching energy vs drain current**

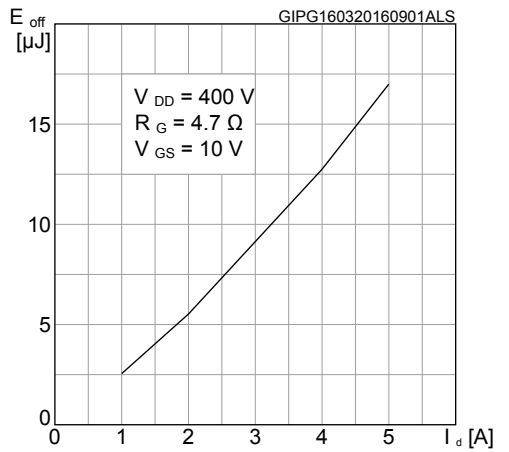

**Figure 9. Normalized gate threshold voltage vs temperature**

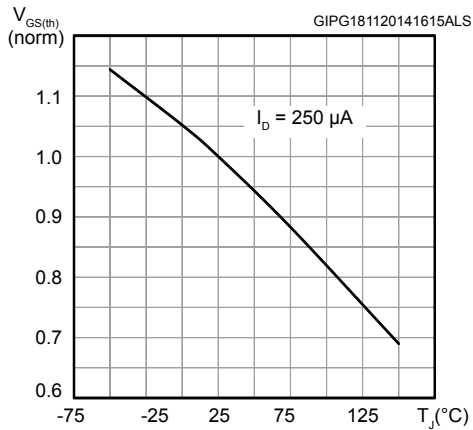

**Figure 10. Normalized on-resistance vs temperature**

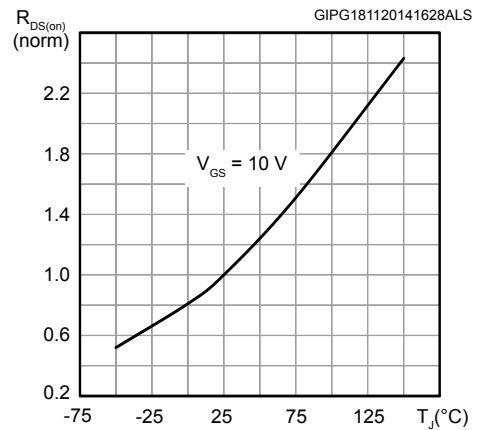

Figure 11. Normalized  $V_{(BR)DSS}$  vs temperature

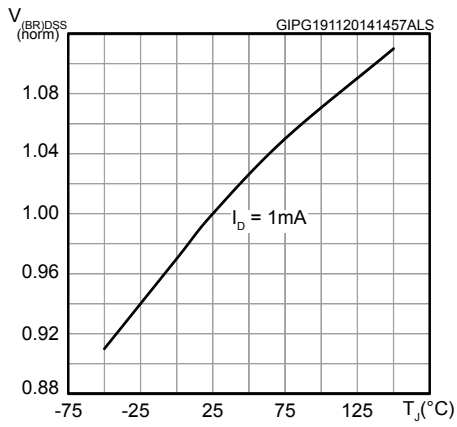

Figure 12. Output capacitance stored energy

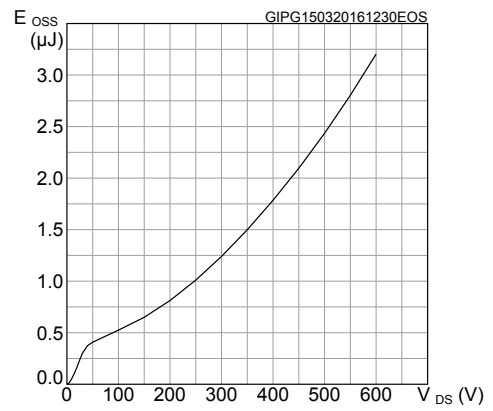
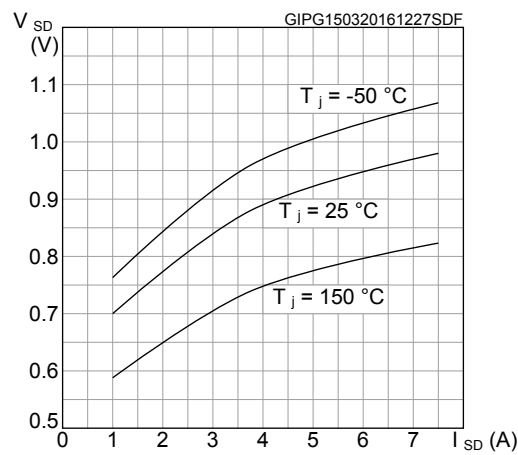
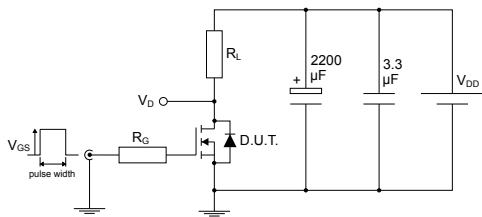

Figure 13. Source-drain diode forward characteristics



### 3 Test circuits

**Figure 14. Test circuit for resistive load switching times**

AM01468v1

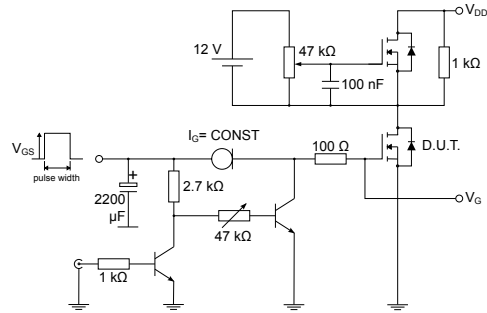
**Figure 15. Test circuit for gate charge behavior**

AM01469v1

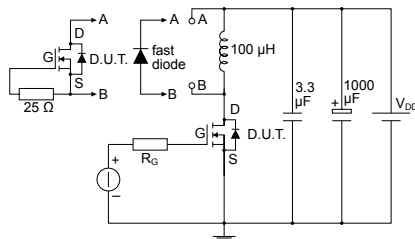
**Figure 16. Test circuit for inductive load switching and diode recovery times**

AM01470v1

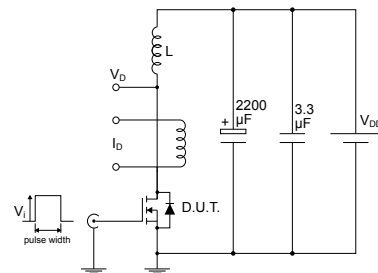
**Figure 17. Unclamped inductive load test circuit**

AM01471v1

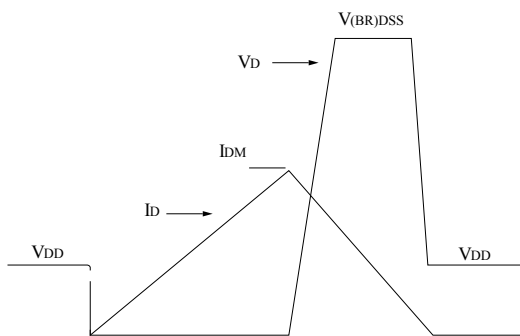
**Figure 18. Unclamped inductive waveform**

AM01472v1

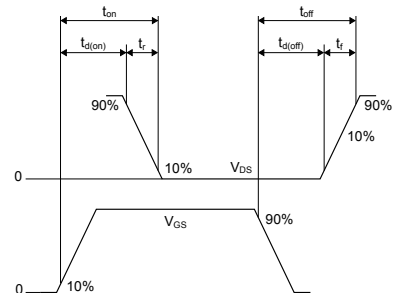
**Figure 19. Switching time waveform**

AM01473v1



## 4 Package mechanical data

---

In order to meet environmental requirements, ST offers these devices in different grades of ECOPACK® packages, depending on their level of environmental compliance. ECOPACK® specifications, grade definitions and product status are available at: [www.st.com](http://www.st.com). ECOPACK® is an ST trademark.

### 4.1 DPAK (TO-252) type A package information

Figure 20. DPAK (TO-252) type A package outline

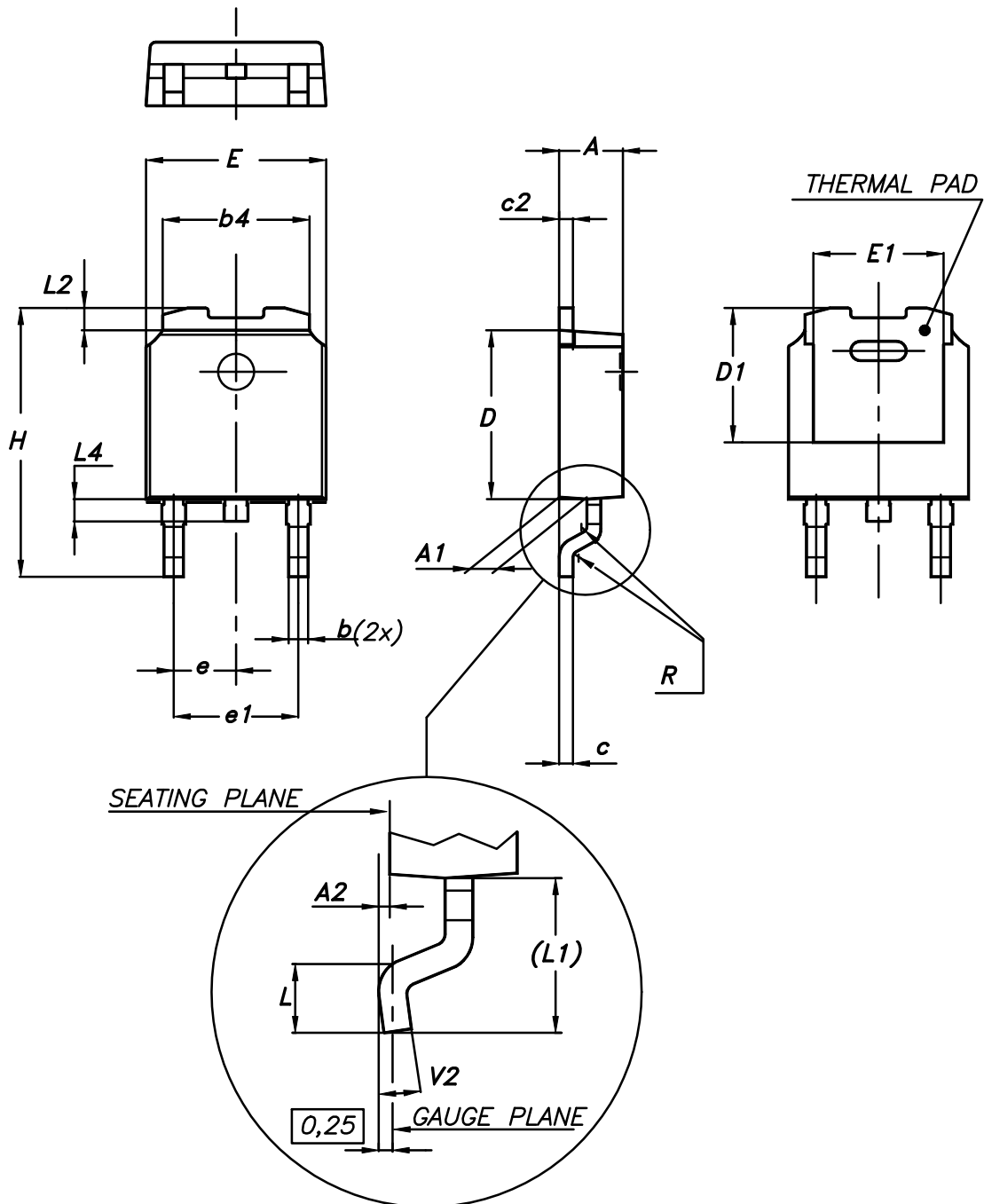

0068772\_A\_24

**Table 9. DPAK (TO-252) type A mechanical data**

Dim.	mm		
	Min.	Typ.	Max.
A	2.20		2.40
A1	0.90		1.10
A2	0.03		0.23
b	0.64		0.90
b4	5.20		5.40
c	0.45		0.60
c2	0.48		0.60
D	6.00		6.20
D1	4.95	5.10	5.25
E	6.40		6.60
E1	4.60	4.70	4.80
e	2.16	2.28	2.40
e1	4.40		4.60
H	9.35		10.10
L	1.00		1.50
(L1)	2.60	2.80	3.00
L2	0.65	0.80	0.95
L4	0.60		1.00
R		0.20	
V2	0°		8°

Figure 21. DPAK (TO-252) type A recommended footprint (dimensions are in mm)

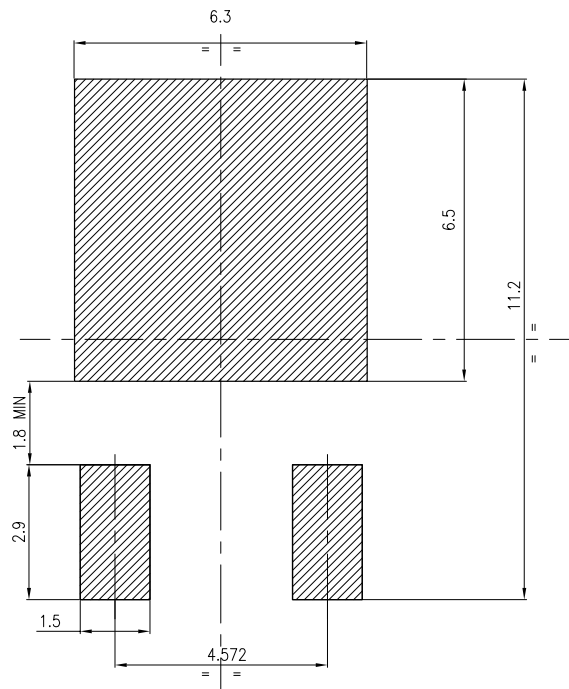

FP\_0068772\_24

## 5 DPAK (TO-252) packing information

Figure 22. DPAK (TO-252) tape outline

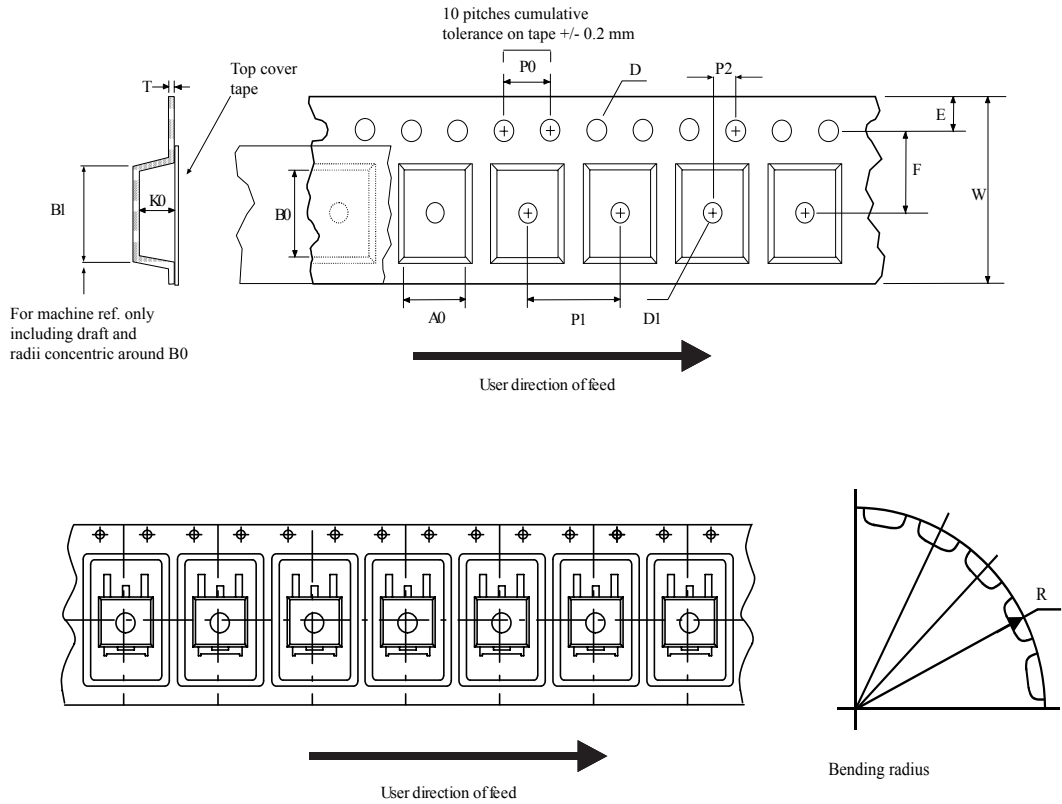

AM08852v1

**Figure 23. DPAK (TO-252) reel outline**

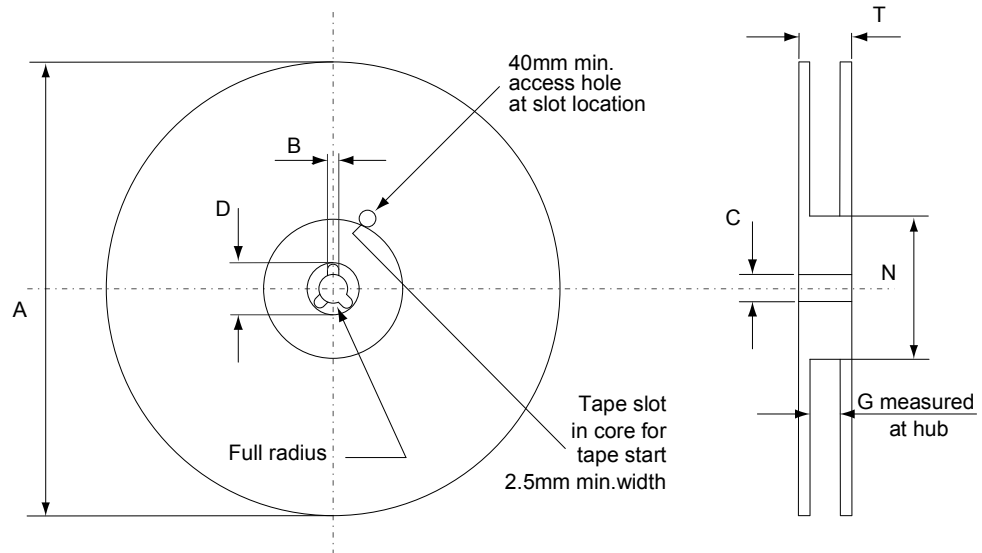

AM06038v1

**Table 10. DPAK (TO-252) tape and reel mechanical data**

Tape			Reel		
Dim.	mm		Dim.	mm	
	Min.	Max.		Min.	Max.
A0	6.8	7	A		330
B0	10.4	10.6	B	1.5	
B1		12.1	C	12.8	13.2
D	1.5	1.6	D	20.2	
D1	1.5		G	16.4	18.4
E	1.65	1.85	N	50	
F	7.4	7.6	T		22.4
K0	2.55	2.75			
P0	3.9	4.1	Base qty.		2500
P1	7.9	8.1	Bulk qty.		2500
P2	1.9	2.1			
R	40				
T	0.25	0.35			
W	15.7	16.3			

## Revision history

**Table 11. Document revision history**

Date	Revision	Changes
12-Apr-2016	1	First release.
07-Mar-2018	2	Removed maturity status indication from cover page. The document status is production data. Modified <i>Table 1. Absolute maximum ratings</i> , <i>Table 4. On/off states</i> , <i>Table 5. Dynamic</i> and <i>Table 8. Source drain diode</i> . Modified <i>Figure 1. Safe operating area</i> , <i>Figure 3. Output characteristics</i> , <i>Figure 4. Transfer characteristics</i> and <i>Figure 5. Gate charge vs gate-source voltage</i> . Minor text changes.
20-Apr-2018	3	Modified <i>Table 1. Absolute maximum ratings</i> , <i>Table 5. Dynamic</i> and <i>Table 8. Source drain diode</i> . Modified <i>Figure 1. Safe operating area</i> . Minor text changes.

## Contents

<b>1</b>	<b>Electrical ratings</b> .....	<b>2</b>
<b>2</b>	<b>Electrical characteristics</b> .....	<b>3</b>
<b>2.1</b>	<b>Electrical characteristics (curves)</b> .....	<b>5</b>
<b>3</b>	<b>Test circuits</b> .....	<b>8</b>
<b>4</b>	<b>Package mechanical data</b> .....	<b>9</b>
<b>4.1</b>	<b>DPAK (TO-252) type A package information</b> .....	<b>9</b>
<b>5</b>	<b>DPAK (TO-252) packing information</b> .....	<b>13</b>
	<b>Revision history</b> .....	<b>15</b>
	<b>Contents</b> .....	<b>16</b>



**IMPORTANT NOTICE – PLEASE READ CAREFULLY**

STMicroelectronics NV and its subsidiaries (“ST”) reserve the right to make changes, corrections, enhancements, modifications, and improvements to ST products and/or to this document at any time without notice. Purchasers should obtain the latest relevant information on ST products before placing orders. ST products are sold pursuant to ST’s terms and conditions of sale in place at the time of order acknowledgement.

Purchasers are solely responsible for the choice, selection, and use of ST products and ST assumes no liability for application assistance or the design of Purchasers’ products.

No license, express or implied, to any intellectual property right is granted by ST herein.

Resale of ST products with provisions different from the information set forth herein shall void any warranty granted by ST for such product.

ST and the ST logo are trademarks of ST. All other product or service names are the property of their respective owners.

Information in this document supersedes and replaces information previously supplied in any prior versions of this document.

© 2018 STMicroelectronics – All rights reserved