

C900AC SFTY X1-440 Y2-300, Ceramic, 4700 pF, 20%, 440 VAC (X1), 300 VAC (Y2), Y5V, Lead Spacing = 7.5mm

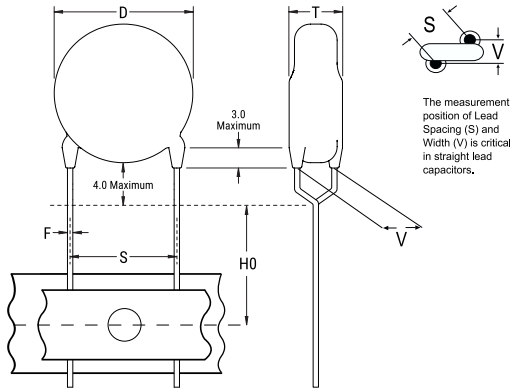

**Dimensions**

<b>D</b>	11mm MAX
<b>T</b>	5mm MAX
<b>S</b>	7.5mm +/-1mm
<b>H0</b>	18mm +2/-0mm
<b>F</b>	0.55mm +/-0.1mm

**Packaging Specifications**

<b>Packaging:</b>	Ammo
<b>Packaging Quantity:</b>	1000

**General Information**

<b>Supplier:</b>	KEMET
<b>Series:</b>	C900AC SFTY X1-440 Y2-300
<b>Style:</b>	Radial Disc
<b>RoHS:</b>	Yes
<b>Termination:</b>	Tin
<b>Failure Rate:</b>	N/A
<b>Qualifications:</b>	UL, ENEC, VDE, CSA, CAN
<b>Halogen Free:</b>	Yes

**Specifications**

<b>Capacitance:</b>	4700 pF
<b>Capacitance Tolerance:</b>	20%
<b>Voltage AC:</b>	440 VAC (X1), 300 VAC (Y2)
<b>Dielectric Withstanding Voltage:</b>	2600 VDC
<b>Temperature Range:</b>	-40/+125C
<b>Temperature Coefficient:</b>	Y5V
<b>Dissipation Factor:</b>	5.00%
<b>Insulation Resistance:</b>	10 GOhms
<b>Safety Class:</b>	X1/Y2