

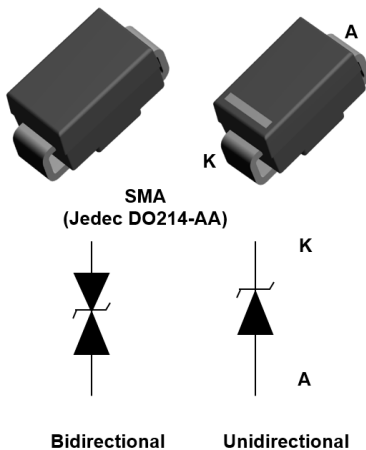

## Automotive 600 W TVS in SMA



## Features

- AEC-Q101 qualified 
- Peak pulse power:
  - 600 W (10/1000  $\mu$ s) and 4 kW (8/20  $\mu$ s)
- Stand-off voltage range: from 5 V to 70 V
- Unidirectional and bidirectional types
- Low leakage current:
  - 0.2  $\mu$ A at 25 °C and 1  $\mu$ A at 85 °C
- Operating  $T_j$  max: 150 °C
- JEDEC registered package outline
- Lead finishing: matte tin plating

## Complies with the following standards

- UL94, V0
- J-STD-020 MSL level 1
- J-STD-002, JESD 22-B102 E3 and MIL-STD-750, method 2026
- JESD-201 class 2 whisker test
- IPC7531 footprint and JEDEC registered package outline
- IEC 61000-4-4 level 4
  - 4 kV
- ISO 10605, IEC 61000-4-2, C = 150 pF, R = 330  $\Omega$  exceeds level 4:
  - 30 kV (air discharge)
  - 30 kV (contact discharge)
- ISO 10605, C = 330 pF, R = 330  $\Omega$  exceeds level 4:
  - 30 kV (air discharge)
  - 30 kV (contact discharge)
- ISO 7637-2 (not applicable to parts with  $V_{RM}$  lower than battery voltage)
  - Pulse 1:  $V_S = -150$  V
  - Pulse 2a:  $V_S = +112$  V
  - Pulse 3a:  $V_S = -220$  V
  - Pulse3b:  $V_S = +150$  V

Product status link

[SMA6TY](#)

## Description

The SMA6TY Transil series has been designed to protect sensitive automotive circuits against surges defined in ISO 7637-2 and against electrostatic discharges according to ISO 10605.

The planar technology makes this device compatible with high-end circuits where low leakage current and high junction temperature are required to provide reliability and stability over time. SMA6TY are packaged in SMA.

Transil™ is a trademark of STMicroelectronics.

# 1 Characteristics

**Table 1. Absolute maximum ratings ( $T_{amb} = 25\text{ }^{\circ}\text{C}$ )**

Symbol	Parameter		Value	Unit
$V_{PP}$	Peak pulse voltage	ISO10605 (C = 330 pF, R = 330 $\Omega$ ):		
		Contact discharge	30	kV
		Air discharge	30	
		ISO10605 / IEC 61000-4-2 (C = 150 pF, R = 330 $\Omega$ )	30	
		Contact discharge	30	
Air discharge	30			
$P_{PP}$	Peak pulse power dissipation	10/1000 $\mu\text{s}$ , $T_j$ initial = $T_{amb}$	600	W
$T_j$	Operating junction temperature range		-40 to +150	$^{\circ}\text{C}$
$T_{stg}$	Storage temperature range		-65 to +150	$^{\circ}\text{C}$
$T_L$	Maximum lead temperature for soldering during 10 s		260	$^{\circ}\text{C}$

**Figure 1. Electrical characteristics - parameter definitions**

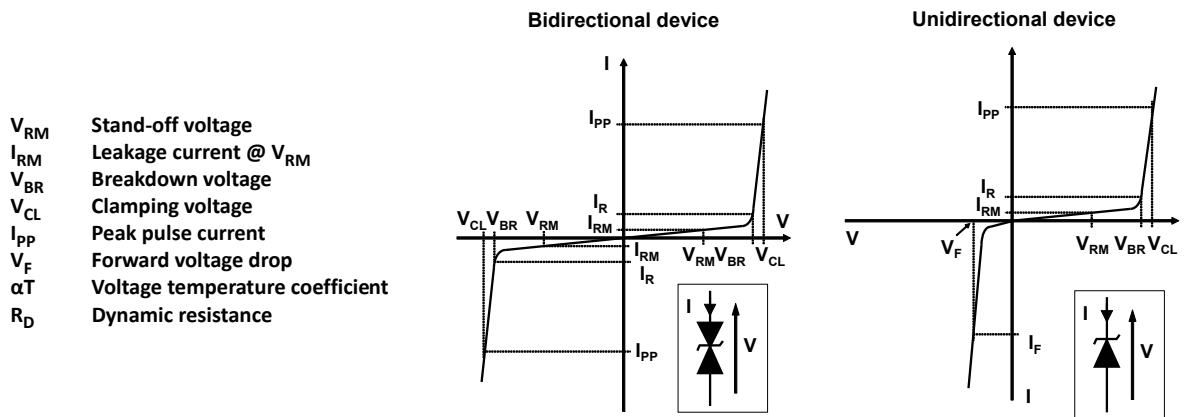

**Table 2. Electrical characteristics (T<sub>amb</sub> = 25 °C, unless otherwise specified)**

Order code	I <sub>RM</sub> max at V <sub>RM</sub>			V <sub>BR</sub> at I <sub>R</sub>				10 / 1000 μs			8 / 20μs			αT <sup>(1)</sup>
	25 °C	85 °C		Min.	Typ.	Max.		V <sub>CL</sub> <sup>(2)</sup>	I <sub>PP</sub> <sup>(3)</sup>	R <sub>D</sub>	V <sub>CL</sub> <sup>(2)</sup>	I <sub>PP</sub> <sup>(3)</sup>	R <sub>D</sub>	
								Max.		Max.	Max.			Max.
	μA	V		V			mA	V	A	Ω	V	A	Ω	10 <sup>-4</sup> /°C
SMA6T6V7AY/CAY	20	50	5.00	6.40	6.40	7.1	10	9.1	68.0	0.029	14.4	275	0.027	5.7
SMA6T7V6AY/CAY	20	50	6.50	7.20	7.60	8.0	10	10.2	56.0	0.04	15.2	266	0.027	6.1
SMA6T10AY/CAY	20	50	8.60	9.50	10.0	10.5	1	14.5	41.0	0.098	18.6	215	0.038	7.3
SMA6T12AY/CAY	0.2	1	10.2	11.4	12.0	12.6	1	16.7	36.0	0.114	21.7	184	0.049	7.8
SMA6T14AY/CAY	0.2	1	12.0	13.3	14.0	14.7	1	18.8	31.0	0.133	23.5	157	0.056	8.3
SMA6T15AY/CAY	0.2	1	12.8	14.3	15.0	15.8	1	21.2	28.0	0.193	27.2	147	0.078	8.4
SMA6T18AY/CAY	0.2	1	15.3	17.1	18.0	18.9	1	25.2	24.0	0.263	32.3	123	0.111	8.8
SMA6T22AY/CAY	0.2	1	18.8	20.9	22.0	23.1	1	30.6	20.0	0.375	39.3	102	0.159	9.2
SMA6T24AY/CAY	0.2	1	20.5	22.8	24.0	25.2	1	33.2	18.0	0.444	42.8	93.0	0.189	9.4
SMA6T28AY/CAY	0.2	1	24	26.7	28.1	29.5	1	37.8	16.0	0.516	44.3	80.0	0.184	9.6
SMA6T30AY/CAY	0.2	1	25.6	28.5	30.0	31.5	1	41.5	14.5	0.690	53.5	75.0	0.293	9.7
SMA6T33AY/CAY	0.2	1	28.2	31.4	33.0	34.7	1	45.7	13.1	0.840	59.0	68.0	0.357	9.8
SMA6T39AY/CAY	0.2	1	33.3	37.1	39.0	41.0	1	53.9	11.1	1.16	69.7	57.0	0.504	10.0
SMA6T47AY/CAY	0.2	1	40.0	44.4	46.7	49.1	1	62.8	9.70	1.42	73.6	48.0	0.511	10.1
SMA6T56AY/CAY	0.2	1	47.6	53.2	56.0	58.8	1	76.6	7.80	2.28	100	40	1.030	10.0
SMA6T68AY/CAY	0.2	1	58.1	64.6	68.0	71.4	1	92.0	6.50	3.17	121	33.0	1.50	10.4
SMA6T82AY/CAY	0.2	1	70.0	77.8	81.9	86.0	1	110	5.50	4.38	120	27	1.030	10.5

1. To calculate V<sub>BR</sub> or V<sub>CL</sub> versus junction temperature, use the following formulas:

- $V_{BR} \text{ at } T_J = V_{BR} \text{ at } 25 \text{ °C} \times (1 + \alpha T \times (T_J - 25))$
- $V_{CL} \text{ at } T_J = V_{CL} \text{ at } 25 \text{ °C} \times (1 + \alpha T \times (T_J - 25))$

2. To calculate maximum clamping voltage at other surge level, use the following formula:

- $V_{CLmax} = V_{BRmax} + R_D \times I_{PPappji}$  where I<sub>PPappji</sub> is the surge current in the application

3. Surge capability given for both directions for unidirectional and bidirectional types.

## 1.1 Characteristics (curves)

Figure 2. Pulse definition for electrical characteristics

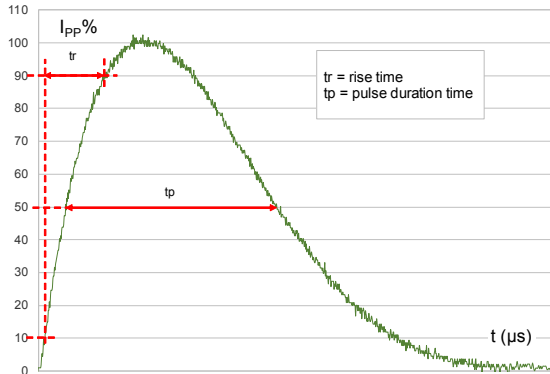

Figure 3. Relative variation of peak power versus initial junction temperature

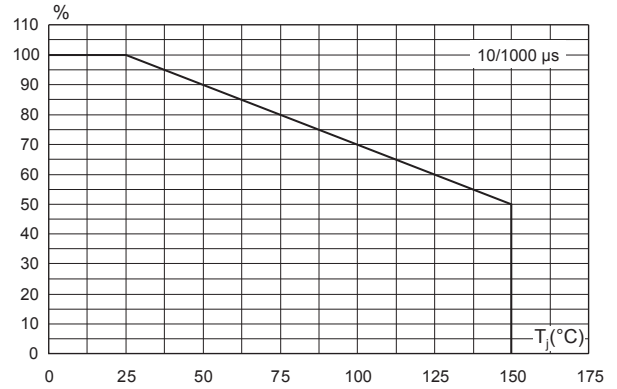

Figure 4. Maximum peak pulse power versus exponential pulse duration

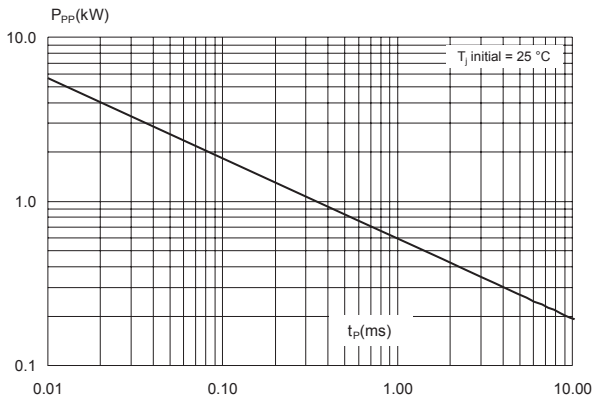
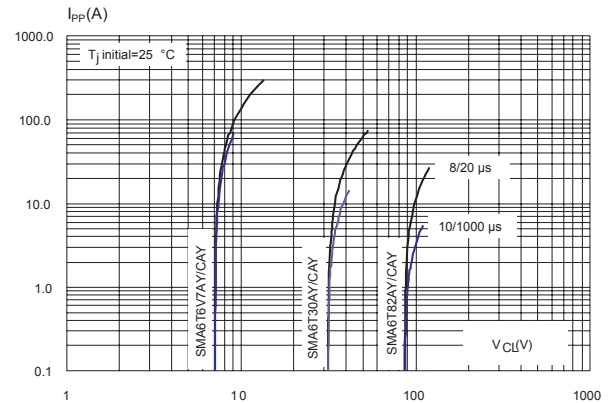
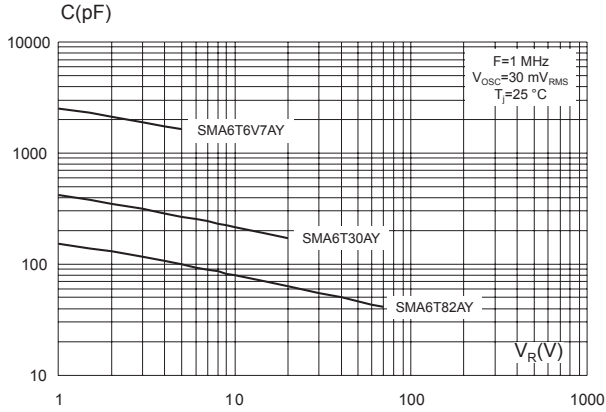
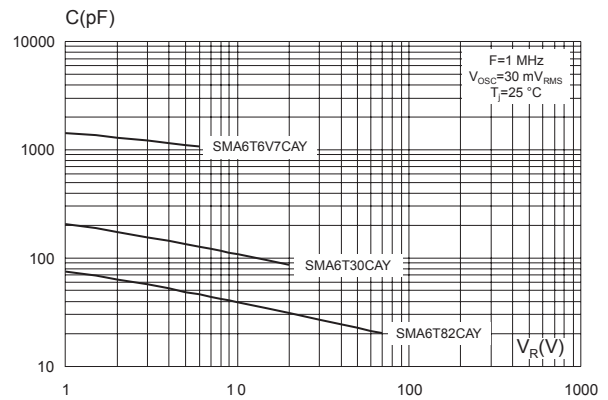
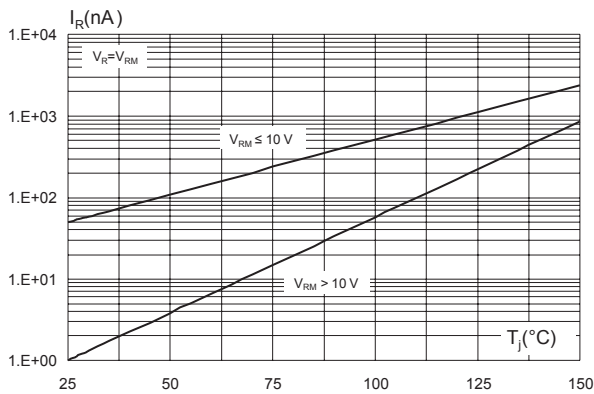
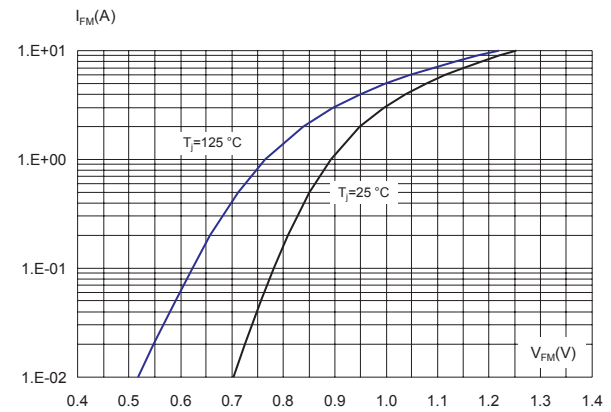
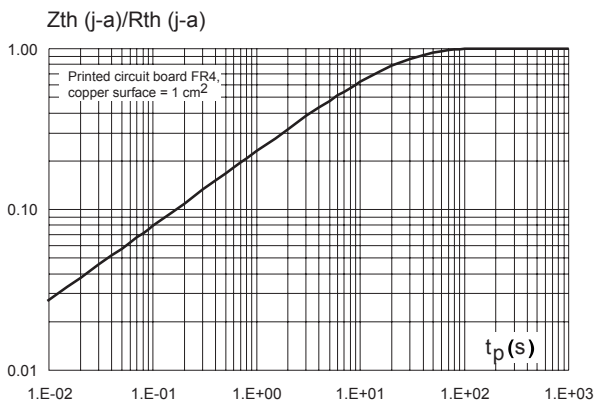
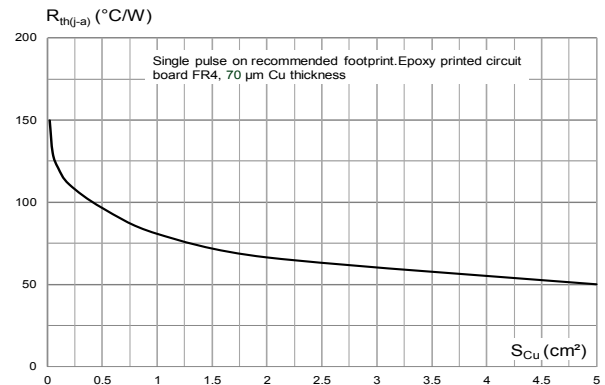
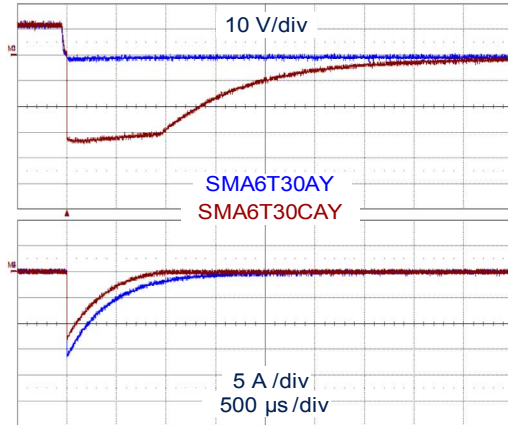

Figure 5. Maximum clamping voltage versus peak pulse current exponential waveform (maximum values)

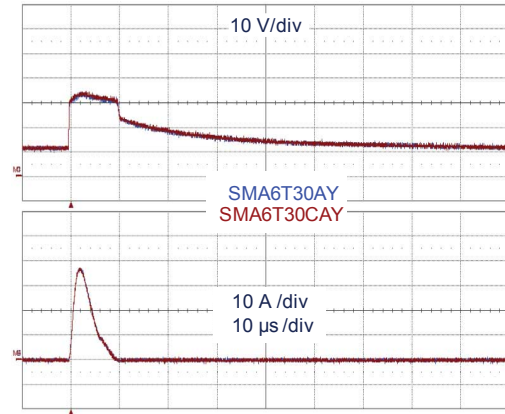

**Figure 6. Junction capacitance versus reverse applied voltage for unidirectional types**

**Figure 7. Junction capacitance versus reverse applied voltage for bidirectional types**

**Figure 8. Leakage current versus junction temperature**

**Figure 9. Peak forward voltage drop versus peak forward current**

**Figure 10. Relative variation of thermal impedance, junction to ambient, versus pulse duration**

**Figure 11. Thermal resistance junction to ambient versus copper surface under each lead**

**Figure 12. ISO7637-2 pulse 1:  $V_s = -150\text{ V}$  with 12 V battery**



**Figure 13. ISO7637-2 pulse 2a:  $V_s = +112\text{ V}$  with 12 V battery**



**Figure 14. ISO7637-2 pulse 3a:  $V_s = -220\text{ V}$  with 12 V battery**

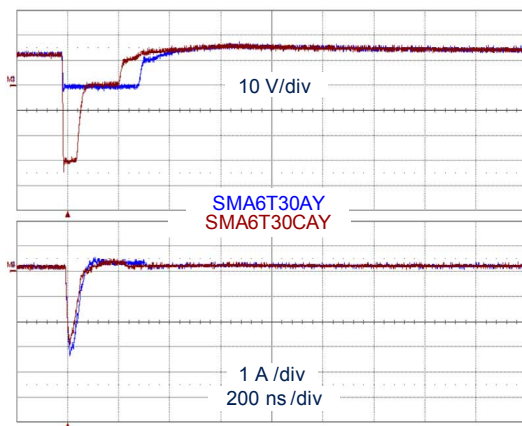

**Figure 15. ISO7637-2 pulse 3b:  $V_s = +150\text{ V}$  with 12 V battery**

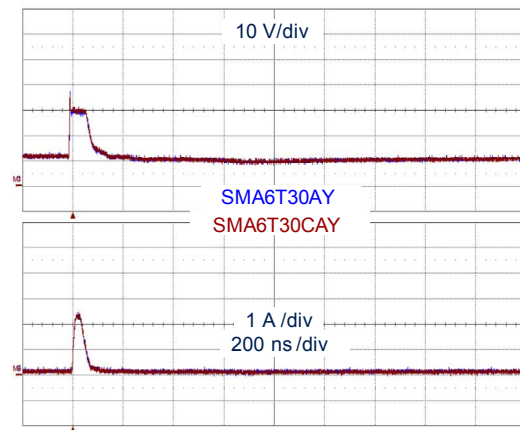

## 2 Package information

In order to meet environmental requirements, ST offers these devices in different grades of **ECOPACK®** packages, depending on their level of environmental compliance. ECOPACK® specifications, grade definitions and product status are available at: [www.st.com](http://www.st.com). ECOPACK® is an ST trademark.

### 2.1 SMA package information

Figure 16. SMA package outline

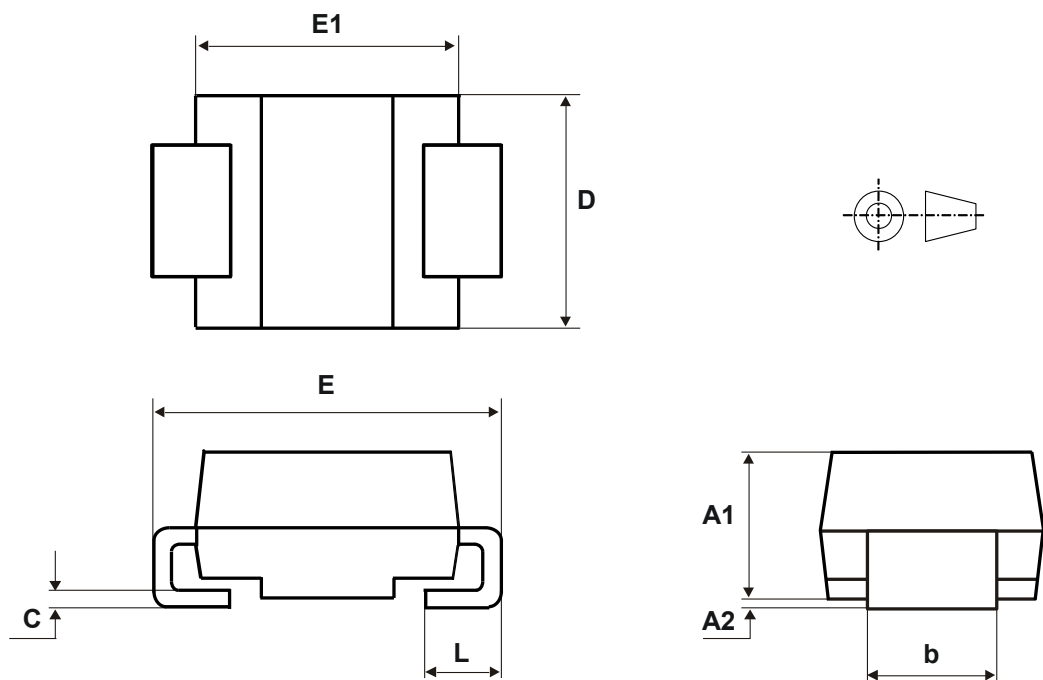

Table 3. SMA package mechanical data

Ref.	Dimensions			
	Millimeters		Inches	
	Min.	Max.	Min.	Max.
A1	1.90	2.45	0.074	0.097
A2	0.05	0.20	0.001	0.008
b	1.25	1.65	0.049	0.065
c	0.15	0.40	0.005	0.016
D	2.25	2.90	0.088	0.115
E	4.80	5.35	0.188	0.211
E1	3.95	4.60	0.155	0.182
L	0.75	1.50	0.029	0.060

Figure 17. SMA recommended footprint in mm (inches)

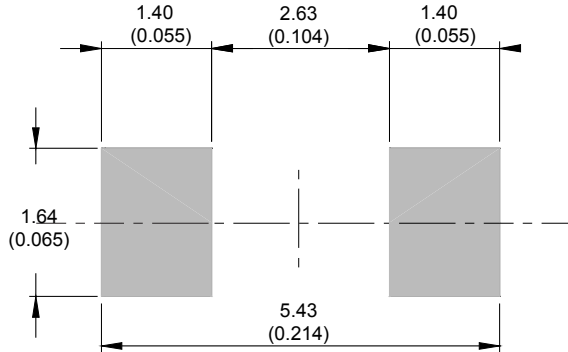

Figure 18. SMA marking

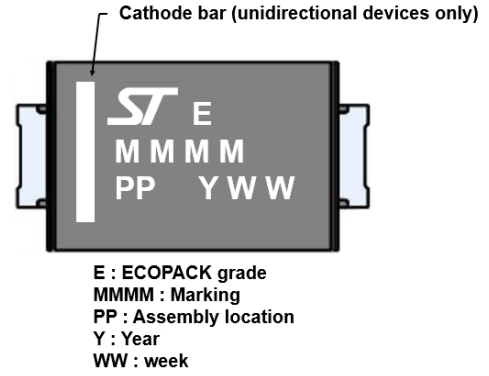
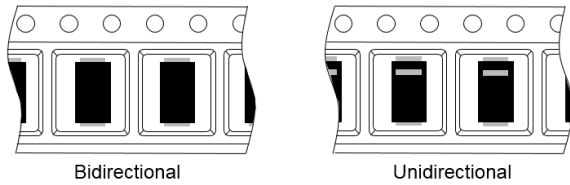

Figure 19. Package orientation in reel



Taped according to EIA-481  
Pocket dimensions are not on scale.  
Pocket shape may vary depending on package  
On bidirectional devices, marking and logo may not be always in the same direction.

Figure 20. Tape and reel orientation

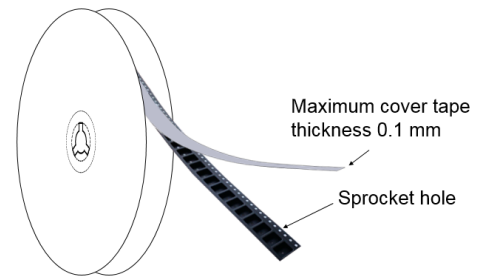

Figure 21. 13" reel dimension values

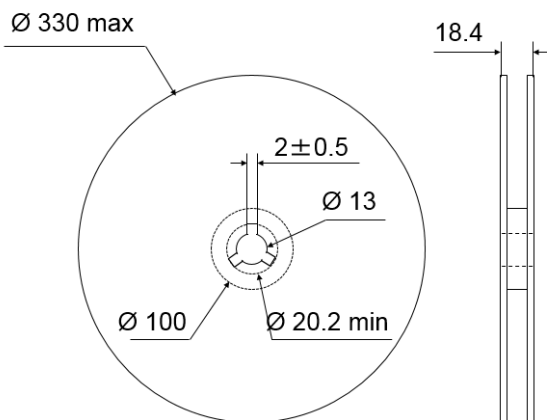

Figure 22. Inner box dimension values

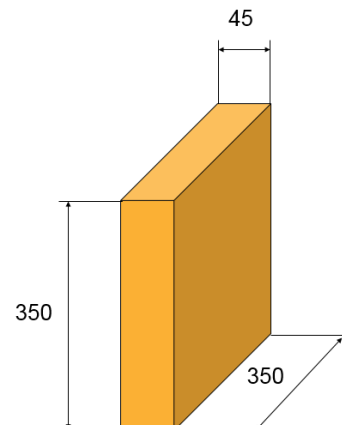
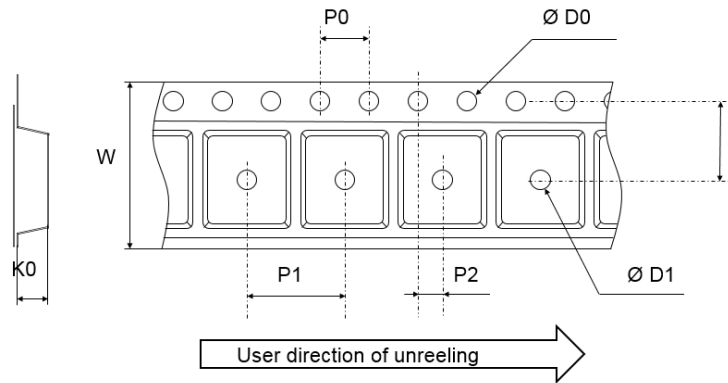



Figure 23. Tape outline



Note: Pocket dimensions are not on scale  
Pocket shape may vary depending on package

Table 4. Tape dimension values

Ref.	Dimensions		
	Millimeters		
	Min.	Typ.	Max.
D0	1.40	1.50	1.60
D1	1.50		
F	5.40	5.50	5.60
K0	2.26	2.36	2.46
P0	3.90	4.00	4.10
P1	3.90	4.00	4.10
P2	1.95	2.00	2.05
W	11.70	12.00	12.30

### 3 Ordering information

Figure 24. Ordering information scheme

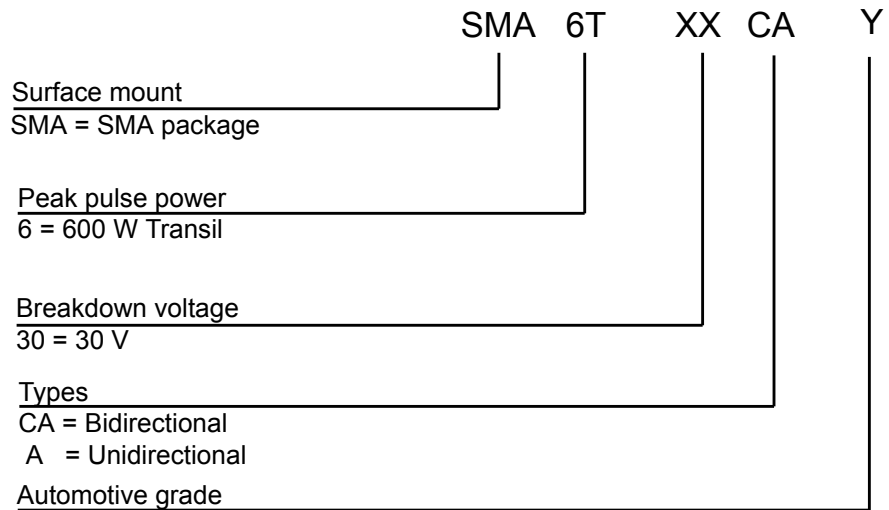

Table 5. Ordering information

Order code	Marking	Package	Weight	Base qty.	Delivery mode
SMA6TxxxAY/CAYSection 3	See Table 6. Marking.	SMA	0.072 g	5000	Tape and reel

**Table 6. Marking**

Order code	Marking	Order code	Marking
SMA6T6V7AY	6UAY	SMA6T6V7CAY	6BAY
SMA6T7V6AY	6UCY	SMA6T7V6CAY	6BCY
SMA6T10AY	6UDY	SMA6T10CAY	6BDY
SMA6T12AY	6UEY	SMA6T12CAY	6BEY
SMA6T14AY	6UFY	SMA6T14CAY	6BFY
SMA6T15AY	6UGY	SMA6T15CAY	6BGY
SMA6T18AY	6UHY	SMA6T18CAY	6BHY
SMA6T22AY	6UJY	SMA6T22CAY	6BJY
SMA6T24AY	6UKY	SMA6T24CAY	6BKY
SMA6T28AY	6UMY	SMA6T28CAY	6BMY
SMA6T30AY	6UNY	SMA6T30CAY	6BNY
SMA6T33AY	6UOY	SMA6T33CAY	6BOY
SMA6T39AY	6UQY	SMA6T39CAY	6BQY
SMA6T47AY	6URY	SMA6T47CAY	6BRY
SMA6T56AY	6USY	SMA6T56CAY	6BSY
SMA6T68AY	6UTY	SMA6T68CAY	6BTY
SMA6T82AY	6UUY	SMA6T82CAY	6BUY

## Revision history

**Table 7. Document revision history**

Date	Revision	Changes
15-Sep-2010	1	Initial release.
18-Oct-2011	2	Deleted old Table 2. Thermal parameter. Updated Table 2 and added order codes in Table 4. Updated Figure 5, Figure 10 and Figure 11.
27-Mar-2012	3	Added footnote on page 1.
25-Jan-2018	4	Updated <a href="#">Table 2. Electrical characteristics</a> ( $T_{amb} = 25\text{ °C}$ , unless otherwise specified).
07-Dec-2018	5	Updated <a href="#">Table 5. Ordering information</a> .

**IMPORTANT NOTICE – PLEASE READ CAREFULLY**

STMicroelectronics NV and its subsidiaries (“ST”) reserve the right to make changes, corrections, enhancements, modifications, and improvements to ST products and/or to this document at any time without notice. Purchasers should obtain the latest relevant information on ST products before placing orders. ST products are sold pursuant to ST’s terms and conditions of sale in place at the time of order acknowledgement.

Purchasers are solely responsible for the choice, selection, and use of ST products and ST assumes no liability for application assistance or the design of Purchasers’ products.

No license, express or implied, to any intellectual property right is granted by ST herein.

Resale of ST products with provisions different from the information set forth herein shall void any warranty granted by ST for such product.

ST and the ST logo are trademarks of ST. All other product or service names are the property of their respective owners.

Information in this document supersedes and replaces information previously supplied in any prior versions of this document.

© 2018 STMicroelectronics – All rights reserved