

Low Profile SMD Power Inductor



Model HA74

Features:

- Operating Temperature Range -50°C to $+155^{\circ}\text{C}$
- Temperature Rise, Maximum 40°C
- RoHS Compliant
- AEC-Q200 Certified



 All parts are Pb-free and comply with EU RoHS Directive 2011/65/EU with amendment (EU) 2015/863 (RoHS 3)

Specifications @ 25°C

Part Number	Inductance $\mu\text{H}^{(1)}$			Heating Current ⁽²⁾ (A) Typ	Isat ⁽³⁾ (Adc) Typ	DCR ⁽⁴⁾ (m Ω)		
	Min	Typ	Max			Min	Typ.	Max
HA74-054R7LFTR	3.76	4.70	5.64	3.60	2.90	60.0	74.0	88.0
HA74-055R6LFTR	4.48	5.60	6.72	3.50	2.80	72.0	81.0	90.0
HA74-056R8LFTR	5.44	6.80	8.16	3.00	2.50	106.0	116.0	126.0
HA74-05100LFTR	8.00	10.00	12.00	2.50	2.00	157.0	164.0	171.0
HA74-05120LFTR	9.60	12.00	14.40	2.40	2.00	175.0	190.0	205.0
HA74-05150LFTR	12.00	15.00	18.00	2.00	1.80	204.0	217.0	230.0
HA74-05180LFTR	14.40	18.00	21.6	1.80	1.60	265.0	275.0	285.0
HA74-05220LFTR	17.60	22.00	26.40	1.60	1.40	295.0	305.0	315.0
HA74-05270LFTR	21.60	27.00	32.40	1.50	1.20	385.0	400.0	415.0
HA74-05330LFTR	26.40	33.00	39.60	1.40	1.20	410.0	440.0	470.0

Notes:

(1) Inductance is measured at 100kHz, 0.1Vrms

(2) The Heating Current is the DC current which causes the component temperature to increase by approximately 40°C . This current is determined by soldering the component on a typical application PCB, and then applying the current to the device for 30 minutes

(3) The saturation current (Isat) is the approximate current at which the inductance will be decreased by 20% typical from its initial (zero DC) value

(4) DCR is measured at room temperature 25°C

General Note

TT Electronics reserves the right to make changes in product specification without notice or liability. All information is subject to TT Electronics' own data and is considered accurate at time of going to print.

Low Profile SMD Power Inductor

Model HA74



Outline Dimensions (mm)

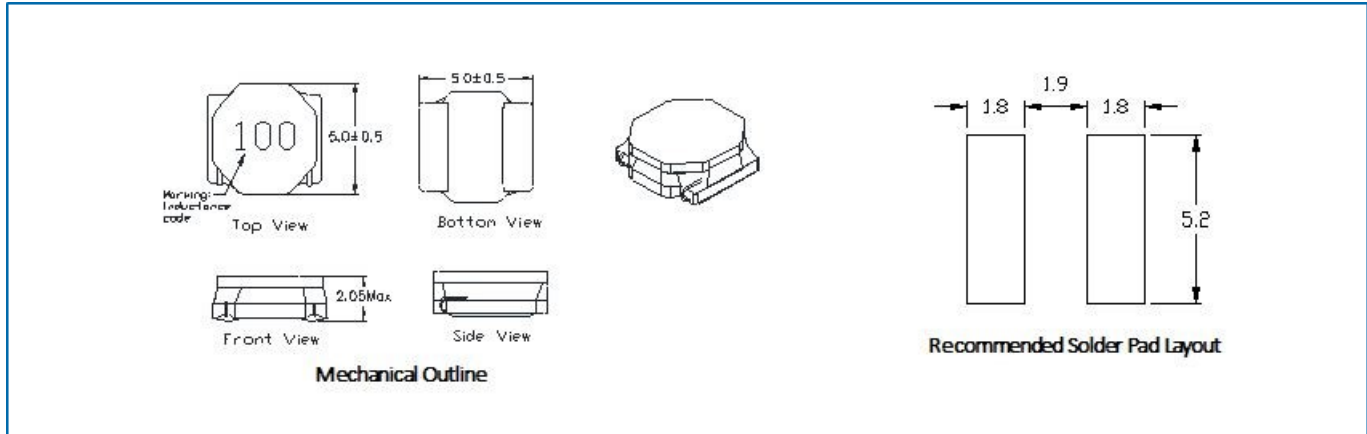

Electrical Characteristics @ 25°C

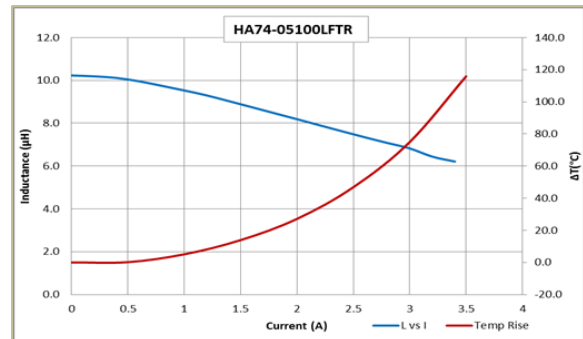
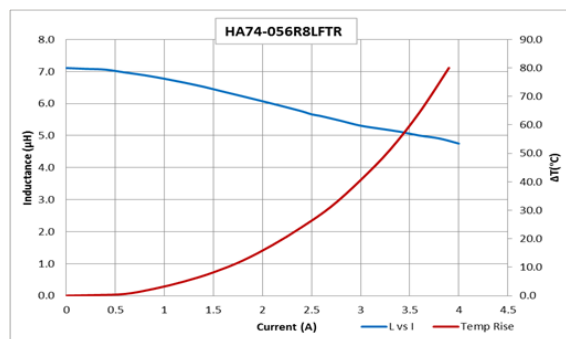
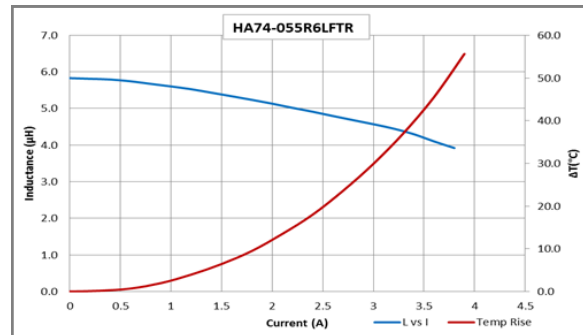
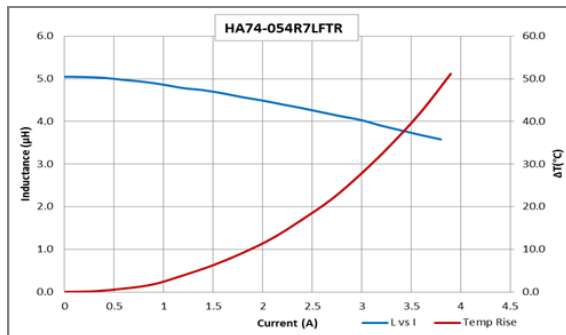

General Note
 TT Electronics reserves the right to make changes in product specification without notice or liability. All information is subject to TT Electronics' own data and is considered accurate at time of going to print.

TT Electronics | BI Technologies
 A-1445, Jalan Tanjung Api,
 25050 Kuantan, Pahang Darul Makmur, Malaysia
 Ph: +60 9 565 8888

Low Profile SMD Power Inductor

Model HA74



Electrical Characteristics @ 25°C

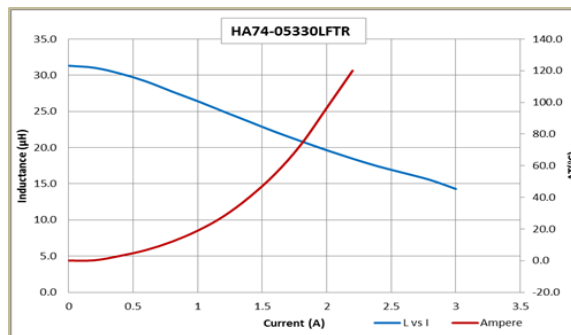
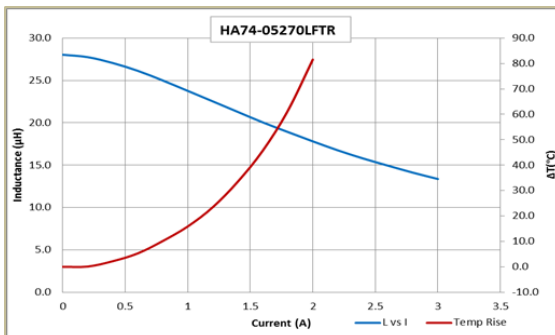
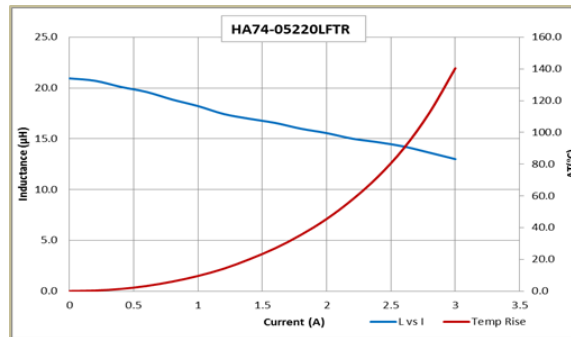
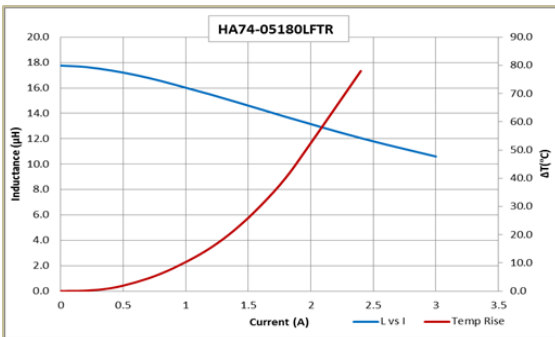
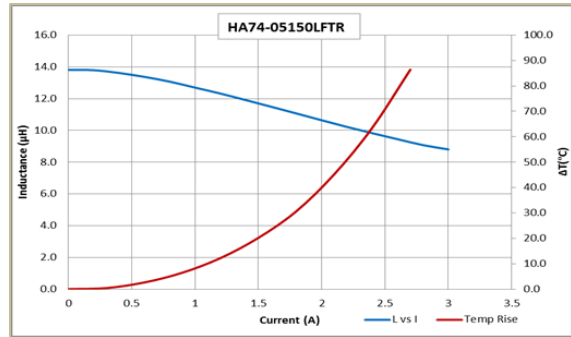
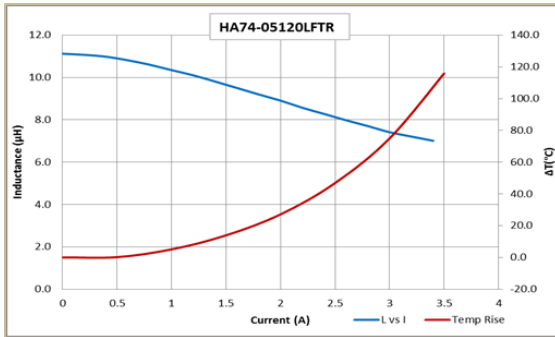

General Note
 TT Electronics reserves the right to make changes in product specification without notice or liability. All information is subject to TT Electronics' own data and is considered accurate at time of going to print.

TT Electronics | BI Technologies
 A-1445, Jalan Tanjung Api,
 25050 Kuantan, Pahang Darul Makmur, Malaysia
 Ph: +60 9 565 8888

Packaging and Ordering Information

HA74 - 05 100 LF TR

Model Series

Model Size : 05x05

Inductance Code:
First 2 digits are significant
Last digit denotes the number of trailing zeros
For values below 10 μ H, "R" denotes the decimal point

One reel	2000 pcs
One shipping carton	6 reels or 12000 pcs