

PLEASE CHECK WWW.MOLEX.COM FOR LATEST PART INFORMATION

Part Number: [1054301103](#)
Status: **Active**
Overview: [Nano-Fit Power Connectors](#)
Description: Nano-Fit Right-Angle Header, Surface Mount, 2.50mm Pitch, Single Row, 3 Circuits, 0.76µm Tin (Sn) Plating, Black, Glow-Wire Capable

Documents:

3D Model	Packaging Specification 1054301000-PK-000 (PDF)
Drawing (PDF)	Test Summary 1054050000-TS-000 (PDF)
Product Specification PS-105405-001-001 (PDF)	RoHS Certificate of Compliance (PDF)
Application Specification AS-105405-001-001 (PDF)	

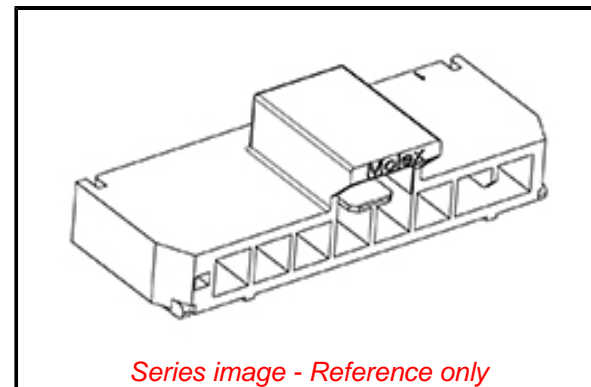

Series image - Reference only

General

Product Family	PCB Headers
Series	105430
3D Viewer	Yes
Application	Power, Wire-to-Board
CURRENT-MAX-NUMERIC	6.5
Overview	Nano-Fit Power Connectors
PITCH-MATING-NUMERIC	2.50
Product Name	Nano-Fit
UPC	191128929516

Physical

Breakaway	No
Circuits (Loaded)	3
Circuits (maximum)	3
Color - Resin	Black
Durability (mating cycles max)	25
Glow-Wire Capable	Yes
Keying to Mating Part	Yes
Lock to Mating Part	Yes
Material - Metal	Brass
Material - Plating Mating	Tin
Material - Plating Termination	Tin
Material - Resin	Liquid Crystal Polymer
Net Weight	0.680/g
Number of Rows	1
Orientation	Right Angle
PCB Locator	No
PCB Thickness - Recommended	1.60mm
Packaging Type	Embossed Tape on Reel
Pitch - Mating Interface	2.50mm
Pitch - Termination Interface	2.50mm
Plating min - Mating	0.762µm
Plating min - Termination	0.762µm
Polarized to Mating Part	Yes
Polarized to PCB	No
Temperature Range - Operating	-40° to +105°C
Termination Interface: Style	Surface Mount

Electrical

Current - Maximum per Contact	6.5A
Voltage - Maximum	250V AC (RMS)

Material Info

Reference - Drawing Numbers

EU ELV

Not Relevant

EU RoHS

Compliant

REACH SVHC

Not Contained Per
-ED/88/2018 (15
January 2019)

Halogen-Free

Status

Low-Halogen

For more information, please visit [Contact US](#)

China ROHS

ELV

RoHS Phthalates

China RoHS

Green Image

Not Relevant

Not Contained

Search Parts in this Series

[105430](#) Series

Mates With

Nano-Fit Receptacle Housing [105307](#)

Use With

Nano-Fit Crimp Terminal [105300](#)

Application Specification
Packaging Specification
Product Specification
Sales Drawing
Test Summary

AS-105405-001-001
1054301000-PK-000
PS-105405-001-001
SD-105430-001-000
1054050000-TS-000

This document was generated on 07/26/2019

PLEASE CHECK WWW.MOLEX.COM FOR LATEST PART INFORMATION