

# Solid State Relays Zero Switching Types RGH Solid State Contactor 'E' Connection

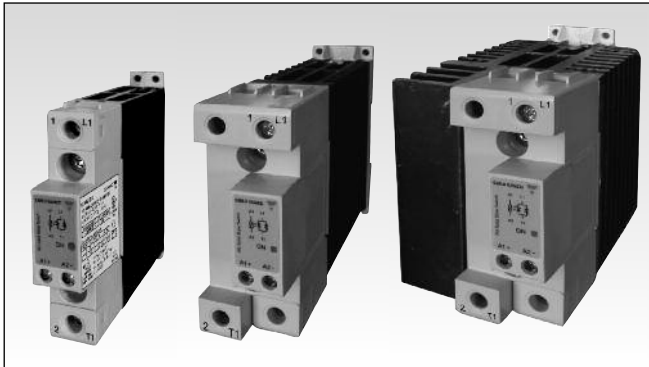

- Product width ranging from 17.5mm to 70mm
- Rated Operational voltage: Up to 600 VAC
- Rated Operational current: Up to 60 AAC @ 40°C
- Up to 6600 A<sup>2</sup>s for I<sup>2</sup>t and 1600Vp blocking voltage
- Control voltages: 4-32 VDC, 20-275 VAC (24-190 VDC)
- IP20 protection
- Design according to EN/IEC60947-4-2, EN/IEC60947-4-3, EN/IEC62314, UL508, CSA22-2 No14-10
- Integrated voltage transient protection with Varistor
- RoHS compliant
- Short circuit current rating: 100kA

## Product Description

This range of Solid State contactors offers the possibility of 1600Vp blocking voltage as well as the use of a less expensive means for short circuit protection due to the use of semiconductors with high I<sup>2</sup>t ratings combined with a small

width dimension for the product which can go as narrow as 17.5mm for the 20A version. The nominal current ratings are at 40°C.

Specifications are stated at 25°C unless otherwise stated.

## Ordering Key **RGH 1 A 60 A 31 K K E**

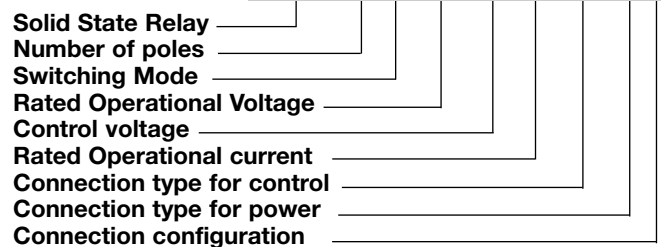

## Ordering Key

1Phase SSR with heatsink	Rated Voltage	Control Voltage	Rated Current	I <sup>2</sup> t	Connection Control	Power	Connection configuration
<b>RGH1A: ZC</b>	60: 600V +10% - 15%, 1600Vp	D: 4-32VDC A: 20-275VAC, 24-190VDC	2: 20AAC 3: 30AAC 4: 40AAC 6: 60AAC	0: Standard 1: High	K: Screw M: Pluggable Spring-loaded	K: Screw G: Box Clamp	E: Contactor

## Selection Guide (ZC = Zero Cross Switching)

Rated Output	Blocking Voltage	Connection Voltage	Control Voltage Control/ Power	Rated Operational Current @ 40°C (I <sup>2</sup> t value in brackets)		
				20 AAC (1800 A <sup>2</sup> s)	20 AAC (6600 A <sup>2</sup> s)	30 AAC (6600 A <sup>2</sup> s)
600VAC, ZC	1600Vp	Screw/ Screw	4-32VDC	RGH1A60D20KKE	RGH1A60D21KKE	RGH1A60D31KKE
		Spring/ Screw	4-32VDC	RGH1A60D20MKE	RGH1A60D21MKE	RGH1A60D31MKE
		Screw/ Screw	20-275VAC, 24-190VDC	RGH1A60A20KKE	RGH1A60A21KKE	RGH1A60A31KKE
		Spring/ Screw	20-275VAC, 24-190VDC	RGH1A60A20MKE	RGH1A60A21MKE	RGH1A60A31MKE
Rated Output	Blocking Voltage	Connection Voltage	Control Voltage Control/ Power	Rated Operational Current @ 40°C (I <sup>2</sup> t value in brackets)		
				40 AAC (1800 A <sup>2</sup> s)	40 AAC (6600 A <sup>2</sup> s)	60 AAC (6600 A <sup>2</sup> s)
600VAC, ZC	1600Vp	Screw/ Box clamp	4-32VDC	RGH1A60D40KGE	RGH1A60D41KGE	RGH1A60D60KGE
		Spring/ Box clamp	4-32VDC	-	RGH1A60D41MGE	-
		Screw/ Box clamp	20-275VAC, 24-190VDC	RGH1A60A40KGE	RGH1A60A41KGE	RGH1A60A60KGE
		Spring/ Box clamp	20-275VAC, 24-190VDC	-	RGH1A60A41MGE	-



## Output Voltage Specifications

Operational voltage range	42-600 VAC, +10% -15% on maximum
Blocking voltage	1600 Vp
Internal varistor	680 V

## Environmental Specifications

Operating Temperature	-40°C to 80°C (-40°F to +176°F)
Storage Temperature	-40°C to 100°C (-40°F to +212°F)
RoHS (2002/95/EC)	Compliant
Impact resistance (EN 50155, EN 61373)	15/11 g/ms
Vibration resistance (2-100Hz, IEC60068-2-26, EN50155, EN61373)	2g per axis
Relative humidity	95% non-condensing @ 40°C
UL flammability rating (housing)	UL 94 V0

## General Specifications

Latching voltage (across L1-T1)	≤20V	Pollution degree	2 (non-conductive pollution with possibilities of condensation)
Operational frequency range	45 to 65Hz	Over-voltage category	III (fixed installations)
Power factor	> 0.5 @ Vrated	Isolation	
Finger Protection	IP20	Input to Output	4000Vrms
Control input status	continuously ON Green LED, when control input is applied	Input&Output to Case	4000Vrms

## Input specifications

	RGH..D.. <sup>1</sup>	RGH..A..
Control voltage range	4 - 32 VDC	20 - 275 VAC, 24 (-10%) - 190VDC
Pick-up voltage	3.8 VDC	20VAC/DC
Drop-out voltage	1 VDC	5VAC/DC
Maximum Reverse voltage	32 VDC	-
Response time pick-up ZC (RGH1A..)	0.5 cycle + 500µs @ 24VDC	2 cycles @ 230VAC/110VDC
Response time drop-out	0.5 cycle + 500µs @ 24VDC	0.5 cycle + 40ms @ 230VAC/ 110VDC
Input current @ 40°C	See diagrams below	See diagrams below

### RG..D..

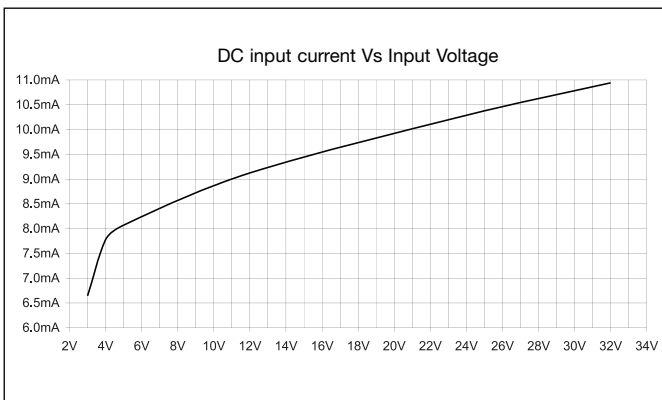

### RG..A..

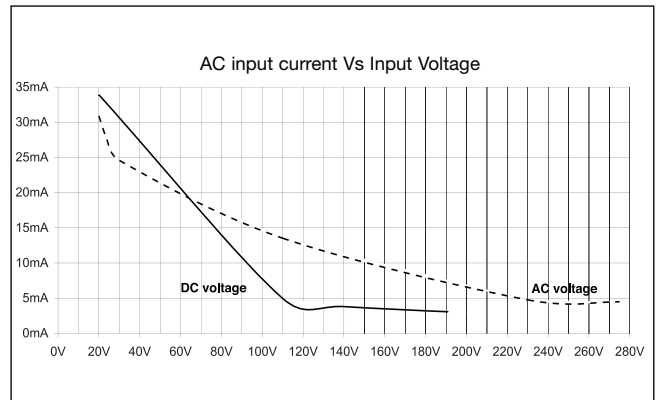

1: DC control to be supplied by a Class 2 power source

**Motor Ratings: HP (UL508) / kW (IEC60947-4-2) @ 40°C**

	115 VAC	230 VAC	400 VAC	480 VAC	600 VAC
RGH..20/21	½HP / 0.18kW	1-½HP / 0.37kW	2HP / 0.75kW	3HP / 1.1kW	3HP / 1.5kW
RGH..31	¾HP / 0.37kW	2HP / 1.1kW	3HP / 1.5kW	5HP / 2.2kW	5HP / 3.7kW
RGH..40	¾HP / 0.37kW	2HP / 1.1kW	3HP / 1.5kW	5HP / 2.2kW	5HP / 3.7kW
RGH..41	1½HP / 0.56kW	3HP / 1.5kW	5HP / 2.2kW	7½HP / 3.7kW	10HP / 4kW
RGH..60	2HP / 0.75kW	3HP / 1.5kW	5HP / 4kW	7½HP / 4kW	10HP / 5.5kW

**Output Specifications (@ 25°C unless otherwise specified)**

	RGH..20	RGH..21	RGH..31	RGH..40	RGH..41	RGH..60
Rated operational current AC-51 rating @ Ta=25°C	25.5 AAC	25.5 AAC	30 AAC	43.7 AAC	49 AAC	75 AAC
AC-51 rating @ Ta=40°C	20 AAC	20 AAC	30 AAC	40 AAC	40 AAC	60 AAC
AC-53a rating @ Ta=40°C	5 AAC	5 AAC	10 AAC	10 AAC	13 AAC	18 AAC
Number of motor starts (x:6, Tx:6s, F:50%) at 40°C <sup>2</sup>	30	30	30	30	30	30
Min. operational current	250 mAAC	400 mAAC	400 mAAC	250 mAAC	400 mAAC	400 mAAC
Rep. overload current - (Motor Rating) PF = 0.4 - 0.5 UL508: T <sub>AMB</sub> =40°C, t <sub>ON</sub> =1s, t <sub>OFF</sub> =9s, 50cycles	60 AAC	60 AAC	84 AAC	84 AAC	126 AAC	144 AAC
Maximum transient surge current (I <sub>TSM</sub> )	600 Ap	1150 Ap	1150 Ap	600 Ap	1150 Ap	1150 Ap
Maximum off-state leakage current	3 mA	3 mA	3 mA	3 mA	3 mA	3 mA
I <sup>2</sup> t (10ms) Minimum	1800 A <sup>2</sup> s	6600A <sup>2</sup> s	6600A <sup>2</sup> s	1800A <sup>2</sup> s	6600A <sup>2</sup> s	6600A <sup>2</sup> s
Critical dv/dt (@ T <sub>j</sub> init = 25°C)	1000 V/us	1000 V/us	1000 V/us	1000 V/us	1000 V/us	1000 V/us

<sup>2</sup> Overload current profile definition:  
x: multiple of AC53a rating, Tx: duration of current surge, F: duty cycle

**Output Power Dissipation**

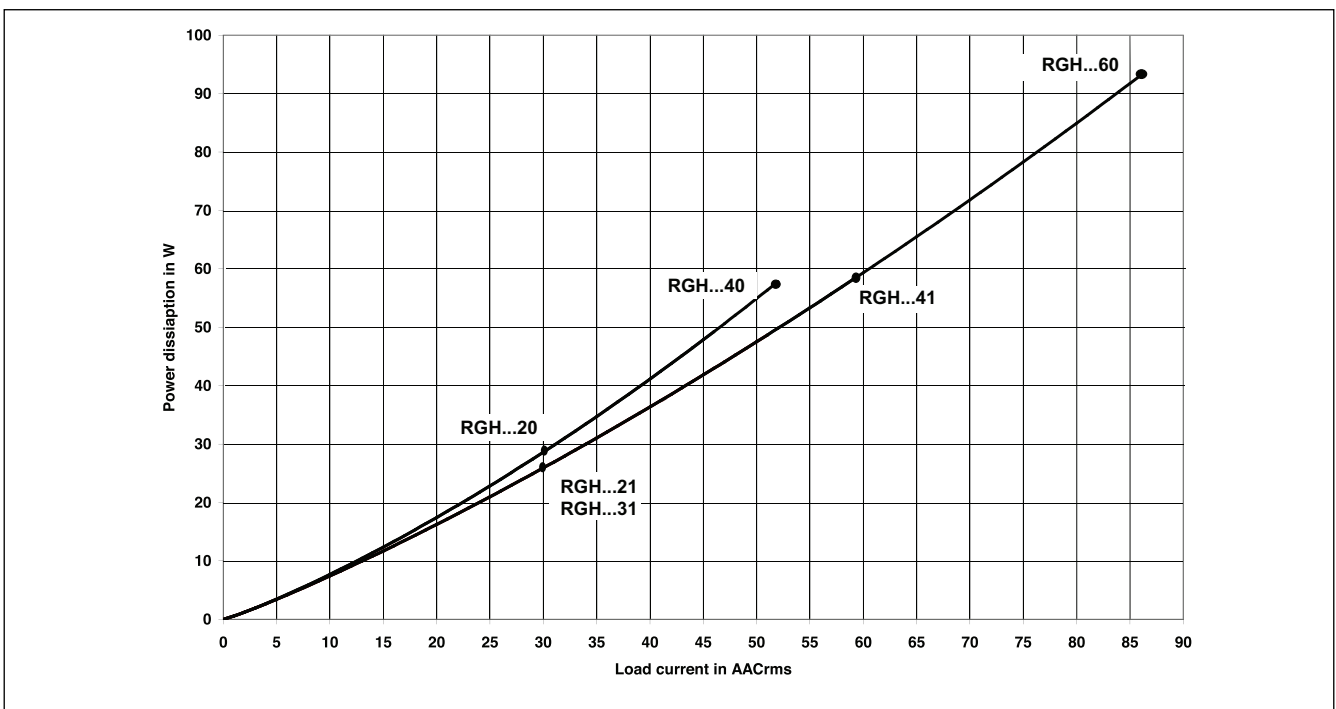

## Current Derating

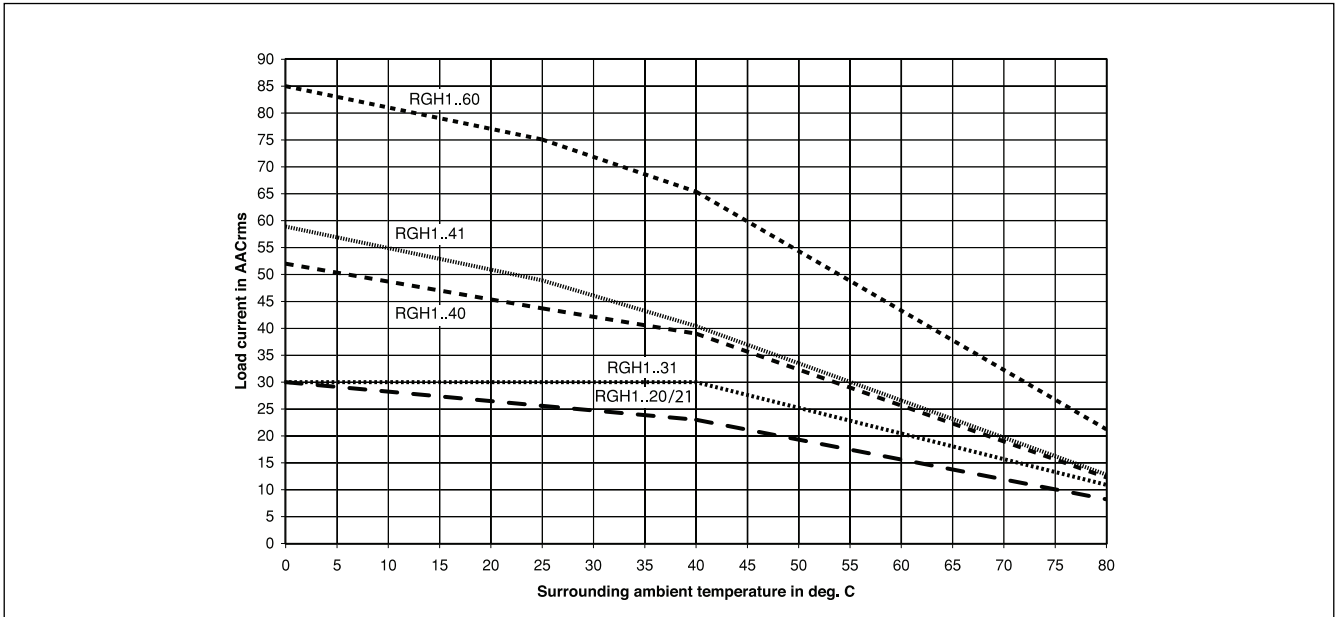

## Agency Approvals and Conformances

<b>Conformance</b>	IEC/EN 62314	<b>Agency Approvals</b>	UL508 Listed (E172877)
	IEC/EN 60947-4-2		cUL Listed (E172877)
	IEC/EN 60947-4-3		VDE (pending)
		<b>Short Circuit Current rating</b>	100kA, UL508

## Electromagnetic Compatibility

<b>EMC Immunity</b>	IEC/EN 61000-6-2	<b>Radiated Radio Frequency Immunity</b>	IEC/EN 61000-4-3
<b>Electrostatic Discharge (ESD) Immunity</b>	IEC/EN 61000-4-2	10V/m, 80 - 1000 MHz	Performance Criteria 1
Air discharge, 8kV	Performance Criteria 1	10V/m, 1.4 - 2.0GHz	Performance Criteria 1
Contact, 4kV	Performance Criteria 1	3V/m, 2.0 - 2.7GHz	Performance Criteria 1
<b>Electrical Fast Transient (Burst) Immunity</b>	IEC/EN 61000-4-4	<b>Conducted Radio Frequency Immunity</b>	IEC/EN 61000-4-6
Output: 2kV, 5kHz	Performance Criteria 1	10V/m, 0.15 - 80 MHz	Performance Criteria 1
Input: 1kV, 5kHz	Performance Criteria 1	<b>Voltage Dips Immunity</b>	IEC/EN 61000-4-11
<b>Electrical Surge Immunity</b>	IEC/EN 61000-4-5	0% for 10ms/20ms,	Performance Criteria 2
Output, line to line, 1kV	Performance Criteria 1	40% for 200ms	Performance Criteria 2
Output, line to earth, 2kV	Performance Criteria 1	70% for 500ms	Performance Criteria 2
Input, line to line, 1kV	Performance Criteria 2	<b>Voltage Interruptions Immunity</b>	IEC/EN 61000-4-11
Input, line to earth, 2kV	Performance Criteria 2	0% for 5000ms	Performance Criteria 2
<b>EMC Emission</b>	EN/IEC 61000-6-4	<b>Radio Interference</b>	
<b>Radio Interference</b>		<b>Field Emission (Radiated)</b>	IEC/EN 55011
<b>Voltage Emission (Conducted)</b>	IEC/EN 55011	30 - 1000MHz	Class A (industrial)
0.15 - 30MHz	Class A (industrial) with filters - see filter information		
	IEC/EN 60947-4-2, 60947-4-3		
	Class A (no filtering needed)		

## Terminal Layout and Dimensions

RGH1A...20KKE, RGH1A...21KKE

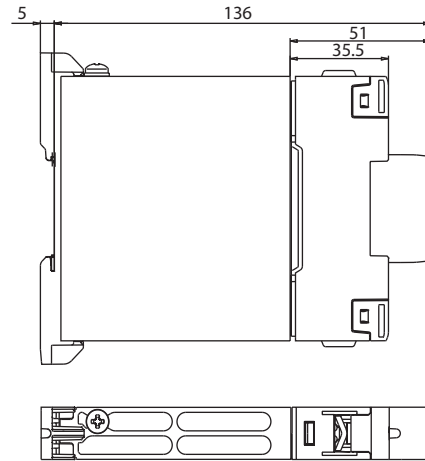
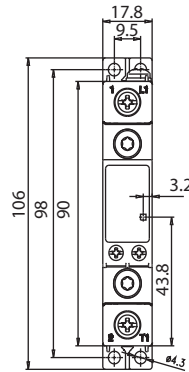
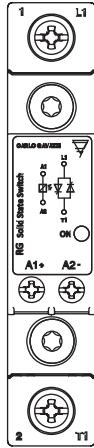

RGH1A...20MKE, RGH1A...21MKE

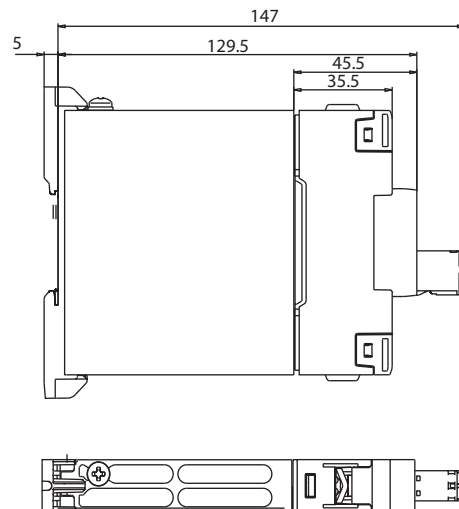
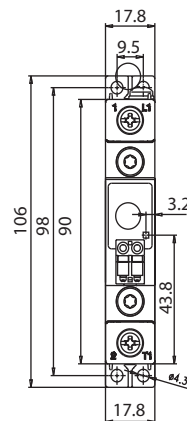
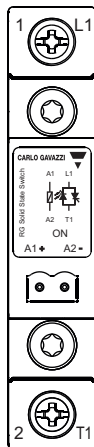

RGH1A...31KKE

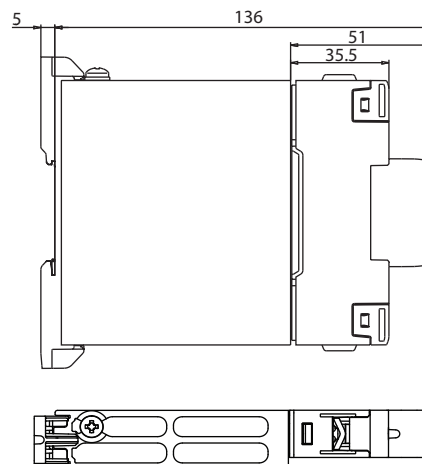
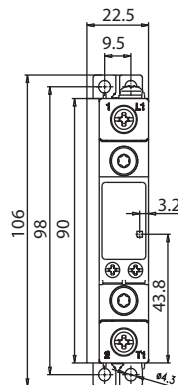
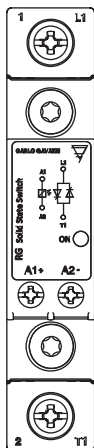

- 1/L1: Supply connection
- 2/T1: Load connection
- A1(+): Positive control signal
- A2(-): Control ground
- ⊕ : Protective earth

\* Housing width tolerance +0.5mm, -0mm...as per DIN43880  
All dimensions in mm

## Terminal Layout and Dimensions (cont.)

RGH1A...31MKE

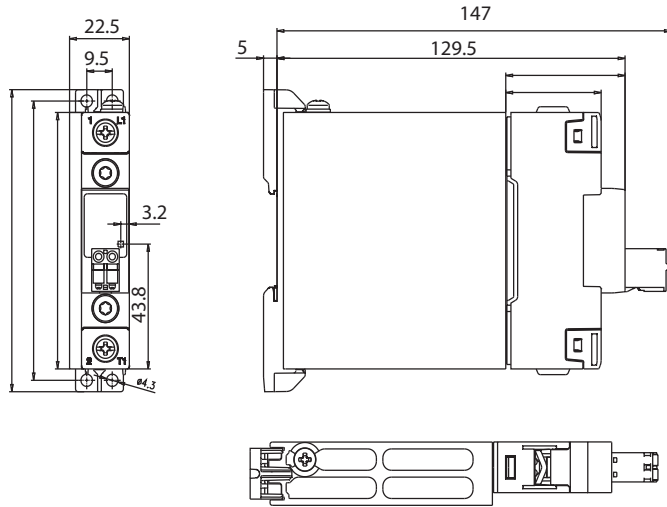
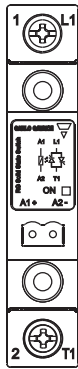

RGH1A...40KGE, RGH1A...41KGE

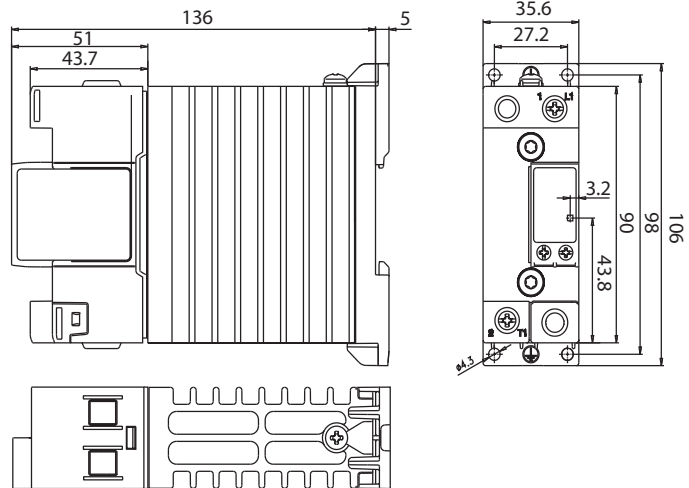
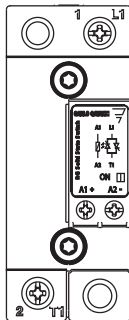

RGH1A...41MGE

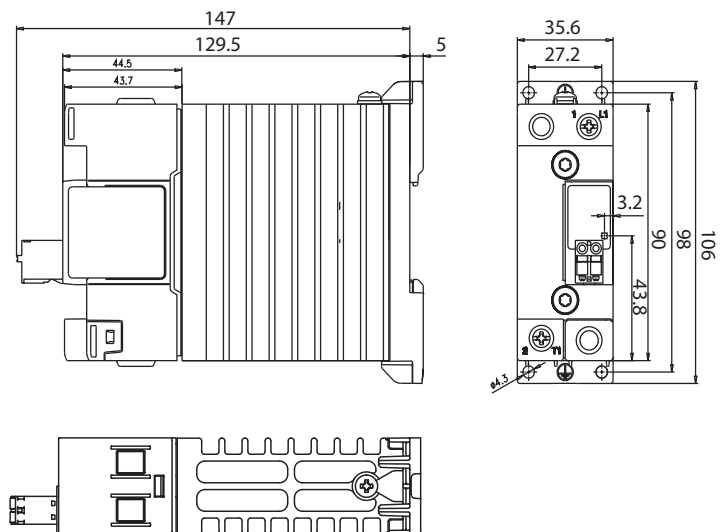
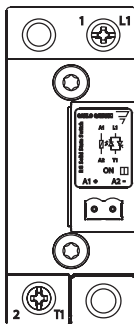

- 1/L1: Supply connection
- 2/T1: Load connection
- A1(+): Positive control signal
- A2(-): Control ground
- ⊕ : Protective earth

\* Housing width tolerance +0.5mm, -0mm...as per DIN43880  
All dimensions in mm

## Terminal Layout and Dimensions (cont.)

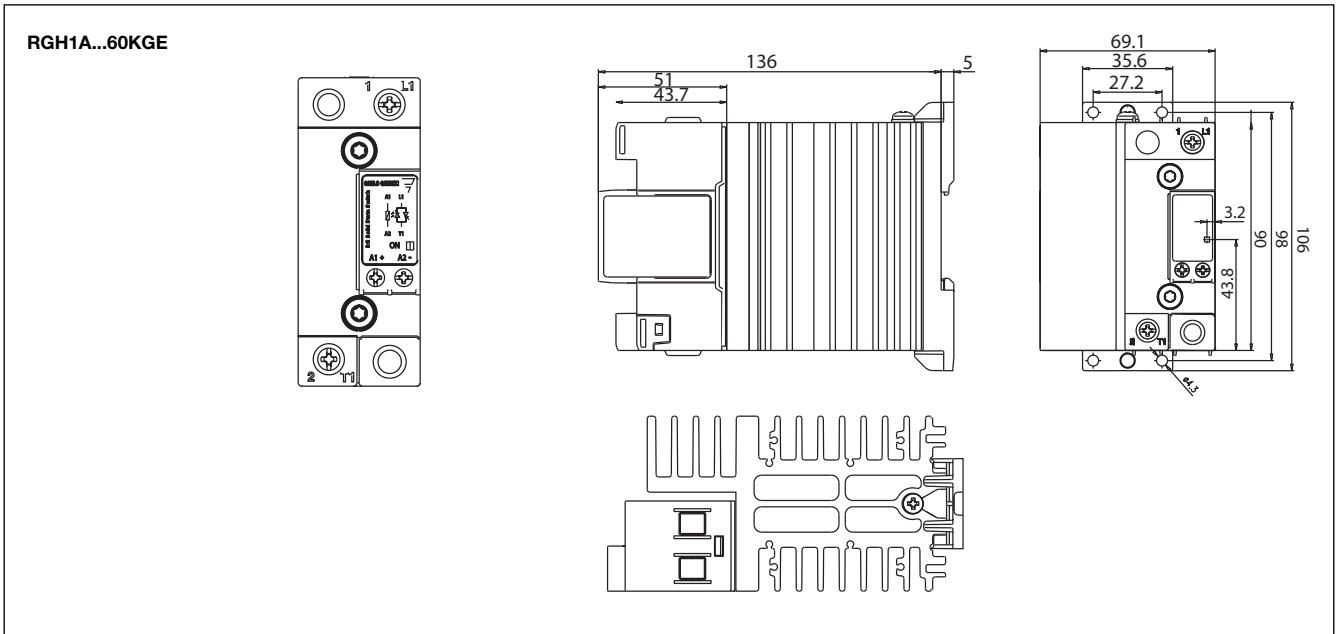

## Filtering - EN / IEC 55011 Class A compliance (for class B compliance contact us)

Part Number	Suggested filter for compliance	Maximum Heater current
RGH1A60..20	150 nF / 760 V / X1	20A
RGH1A60..21	220 nF / 760 V / X1	20A
RGH1A60..31	220 nF / 760 V / X1	30A
RGH1A60..40/41	330 nF / 760 V / X1	40A
RGH1A60..60	330 nF / 760 V / X1 470 nF / 760 V / X1	40A 65A

Note:

- Control input lines must be installed together to maintain products' susceptibility to Radio Frequency interference.
- Use of AC solid state relays may, according to the application and the load current, cause conducted radio interferences. Use of mains filters may be necessary for cases where the user must meet E.M.C requirements. The capacitor values given inside the filtering specification tables should be taken only as indications, the filter attenuation will depend on the final application.
- Performance Criteria 1: No degradation of performance or loss of function is allowed when the product is operated as intended.
- Performance Criteria 2: During the test, degradation of performance or partial loss of function is allowed. However when the test is complete the product should return operating as intended by itself.
- Performance Criteria 3: Temporary loss of function is allowed, provided the function can be restored by manual operation of the controls.

## Filter Connection Diagrams

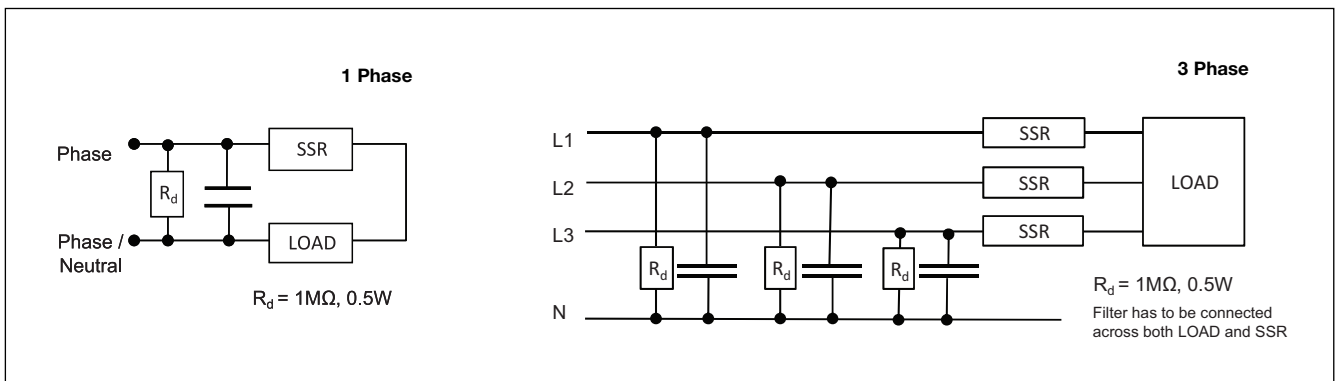

## Connection Diagram

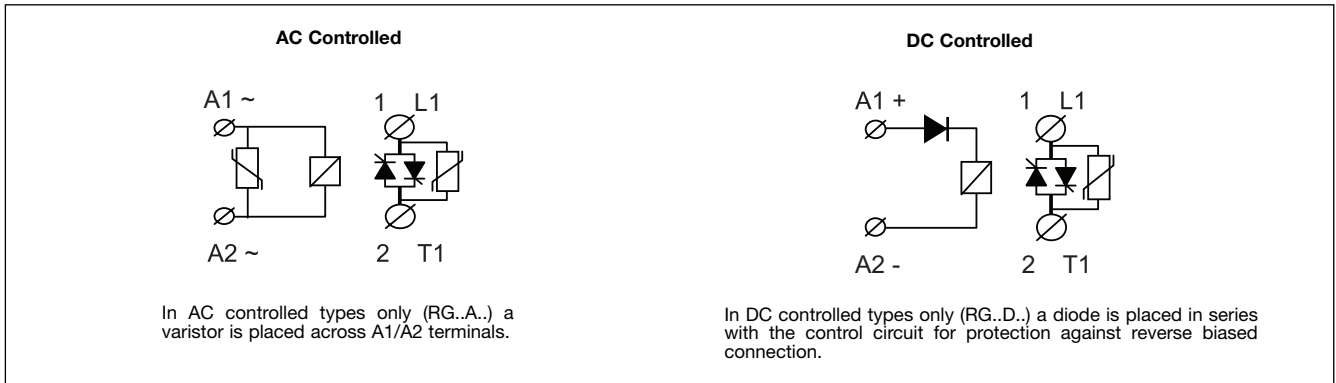

## Connection Specifications

### POWER CONNECTIONS: 1/L1, 2 /T2

Use 75°C copper (Cu) conductors

**RGH..20/21; RGH..31**    **RGH..40/41; RGH..60**

Stripping Length (X)	12mm	11mm
Connection type	M4 screw with captivated washer	M5 screw with box clamp

### Rigid (Solid & Stranded) UL/ cUL rated data

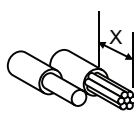
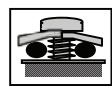
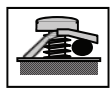
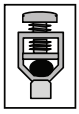
			
	2 x 2.5..6 mm <sup>2</sup> 2 x 14.. 10 AWG	1 x 2.5..6 mm <sup>2</sup> 1 x 14.. 10 AWG	1 x 6..25mm <sup>2</sup> 1 x 10.. 3 AWG

### Flexible with end sleeve

	2 x 2.5..4mm <sup>2</sup> 2 x 14.. 12 AWG	1 x 2.5..4mm <sup>2</sup> 1 x 14.. 12 AWG	1 x 2.5..16mm <sup>2</sup> 1 x 14.. 6 AWG
---	--	--	--



### Flexible without end sleeve

	2 x 2.5.. 6mm <sup>2</sup> 2 x 14.. 10 AWG	1 x 2.5.. 6mm <sup>2</sup> 1 x 14.. 10 AWG	1 x 4.. 25mm <sup>2</sup> 1 x 12.. 3 AWG
---	---	---	---

Torque specifications	2 Nm (17.7 in-lb). M4, Pozidriv 2	2.5 Nm (22 in-lb). M5, Pozidriv 2
		

Aperture for termination lug	12.3mm	-
------------------------------	--------	---

### Protective Earth Connection

	RGH..20, 21: M4, 1.5Nm (13.3 in-lb)
	RGH..31, 40, 41 60: M5, 1.5Nm (13.3 in-lb)

Note: Protective Earth connection must be connected whenever the product is intended to be used in Class 1 applications according to EN/IEC 61140.

### CONTROL CONNECTIONS: A1(+), A2(-) for RGH...K.E

#### Torque specifications

	0.5 Nm (4.4 in-lb) M3, Pozidriv 1 Use 60/75°C copper (Cu) conductors 8mm
---	--

#### Stripping Length (X)

#### Rigid (Solid & Stranded) UL/ cUL rated data

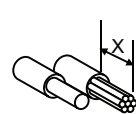
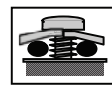
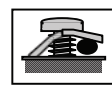
		
	2 x 0.5..2.5mm <sup>2</sup> 2 x 18..12 AWG	1 x 0.5..2.5mm <sup>2</sup> 1 x 18..12 AWG

#### Flexible with end sleeve



	2 x 0.5..2.5mm <sup>2</sup> 2 x 18..12AWG	1 x 0.5..2.5mm <sup>2</sup> 1 x 18..12AWG
--	--	--

### CONTROL CONNECTIONS: A1(+), A2(-) for RGH...M.E

Use 60/75°C copper (Cu) conductors

Stripping Length (X)	12 - 13mm
----------------------	-----------

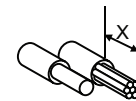
#### Rigid (Stranded) UL/ cUL rated data

	
	1 x 0.2...2.5mm <sup>2</sup> 1 x 24...12 AWG



## Installation Instructions

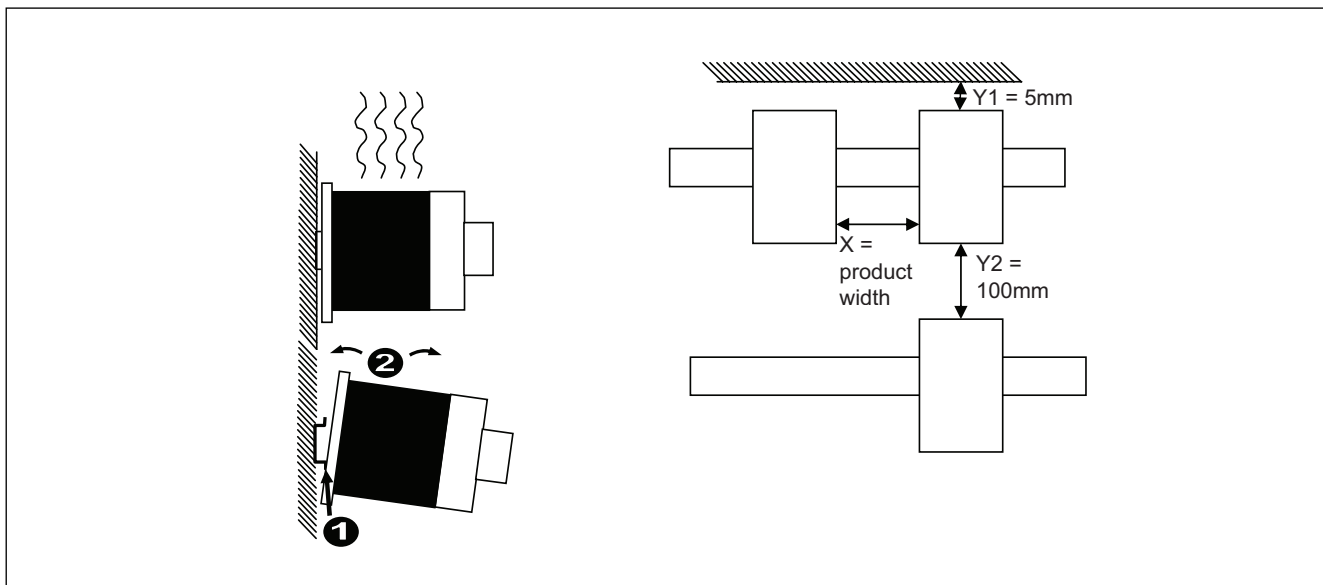

## Short Circuit Protection

### Protection Co-ordination, Type 1 vs Type 2:

Type 1 protection implies that after a short circuit, the device under test will no longer be in a functioning state. In type 2 co-ordination the device under test will still be functional after the short circuit. In both cases, however the short circuit has to be interrupted. The fuse between enclosure and supply shall not open. The door or cover of the enclosure shall not be blown open. There shall be no damage to conductors or terminals and the conductors shall not separate from terminals. There shall be no breakage or cracking of insulating bases to the extent that the integrity of the mounting of live parts is impaired. Discharge of parts or any risk of fire shall not occur.

The product variants listed in the table hereunder are suitable for use on a circuit capable of delivering not more than 100,000 A rms Symmetrical Amperes, 600 Volts maximum when protected by fuses. Tests at 100,000 A were performed with Class J fuses, fast acting; please refer to the table below for maximum allowed ampere rating of the fuse. Use fuses only.

### Co-ordination type 1 (UL508)

Part No.	Max. size [A]	Class	Current [kA]	Voltage [VAC]
RGH..20	30	J	100	Max. 600
RGH..21	30	J	100	Max. 600
RGH..31	30	J	100	Max. 600
RGH..40	30	J	100	Max. 600
RGH..41	40	J	100	Max. 600
RGH..60	40	J	100	Max. 600

### Co-ordination type 2 (IEC EN 60947-4-2/ -4-3)

Part No.	Ferraz Shawmut		Siba		Current [kA]	Voltage [VAC]
	Max size [A]	Part number	Max size [A]	Part number		
RGH..20	50	A70QS50-4	-	-	100	Max. 600
RGH..21	100	A70QS100-4	100	50 194 20.100	100	Max. 600
RGH..31	100	A70QS100-4	100	50 194 20.100	100	Max. 600
RGH..40	50	A70QS50-4	-	-	100	Max. 600
RGH..41	100	A70QS100-4	100	50 194 20.100	100	Max. 600
RGH..60	100	A70QS100-4	100	50 194 20.100	100	Max. 600

## Protection with Miniature Circuit Breakers

Solid State Relay type	Model no. for Z - type M. C. B. (rated current)	Model no. for B - type M. C. B. (rated current)	Wire cross sectional area [mm <sup>2</sup> ]	Minimum length of Cu wire conductor [m] <sup>3</sup>	
RGH..20, RGH..40	S201 - Z10 (10A)	S201-B4 (4A)	1.0	7.6	
			1.5	11.4	
			2.5	19.0	
	S201 - Z16 (16A)	S201-B6 (6A)	1.0	5.2	
			1.5	7.8	
			2.5	13.0	
			4.0	20.8	
	S201 - Z20 (20A)	S201-B10 (10A)	1.5	12.6	
			2.5	21.0	
	S201 - Z25 (25A)	S201-B13 (13A)	2.5	25.0	
			4.0	40.0	
	S202 - Z25 (25A)	S202-B13 (13A)	2.5	19.0	
			4.0	30.4	
	RGH..21 RGH..31 RGH..41 RGH..60	S201 - Z20 (20A)	S201-B10 (10A)	1.5	4.2
				2.5	7.0
4.0				11.2	
S202 - Z20 (20A)	S202-B10 (10A)	1.5	1.8		
		2.5	3.0		
		4.0	4.8		
S201 - Z32 (32A)	S201-B16 (16A)	2.5	13.0		
		4.0	20.8		
		6.0	31.2		
S202 - Z32 (32A)	S202-B16 (16A)	2.5	5.0		
		4.0	8.0		
		6.0	12.0		
		10.0	20.0		
S202 - Z50 (50A)	S202-B25 (25A)	4.0	14.8		
		6.0	22.2		
		10.0	37.0		

3. between MCB and SSR Relay (including return path which goes back to the mains).

Note: A prospective current of 6kA and a 230/400V power supply system is assumed for the above suggested specifications. For cables with different cross section than those mentioned above please consult Carlo Gavazzi's Technical Support Group.