

## General Description

The MAX17843 evaluation kit (EV kit) demonstrates the capabilities of the MAX17843 12-channel, high-voltage smart sensor data-acquisition interface IC. Vertical headers (P2, P3, P5, and P6) allow for the connection of multiple EV kits, supporting up to a 32-device (max) daisy-chain configuration.

## Benefits and Features

- Battery-Cell String Emulation
- UART Interface
- Windows XP®, Windows Vista®, Windows® 7-, and Windows 10-Compatible Software
- Proven PCB Layout
- Fully Assembled and Tested

## MAX17843 EV Kit Files

FILE	DESCRIPTION
MAX17843_EvKit_Installer.exe	GUI

Ordering Information appears at end of data sheet.

## Quick Start

The following procedure describes the setup and testing of a two-module, distributed, daisy-chained system using the MAX17843 IC. The user can choose to configure as many EV kit modules as needed, based on their system and testing requirements.

## Required Equipment

- Two MAX17843 EV kits
- One MAX17841B EV kit (includes a MINIQUSB command module)
- Maxim command module (MINIQUSB)
  - MINIQUSB board
  - MINIQUSB-XHV board (do not use this board)
- Two 9V to 60V DC power supplies (refer to the MAX17843 IC data sheet for recommended operating ranges)
- User-supplied Windows XP®, Windows Vista®, Windows® 7, Windows® 10-compatible PC with a spare USB port

**Note:** In the following sections, software-related items are identified by bolding. Text in **bold** refers to items directly from the EV kit software. Text in **bold and underlined** refers to items from the Windows operating system.

*Windows, Windows XP, and Windows Vista are registered trademarks and registered service marks of Microsoft Corporation.*

## Procedure

The MAX17843 EV kit is fully assembled and tested. Follow the steps below to verify board operation.

**Caution: Do not enable the power supplies until all connections are completed.**

- 1) Install the EV kit software on your computer by running the MAX17843\_EvKit\_Installer.exe file.
- 2) Connect the MINIQUSB module to the J3 and J4 headers on the MAX17841B EV kit.
- 3) Connect the USB cable from the PC to the MINIQUSB board. A **Building Driver Database** window pops up in addition to a **New Hardware Found** message if this is the first time the EV kit board is connected to the PC. If a window is not seen like the one described above after 30s, remove the USB cable from the MINIQUSB and reconnect it. Administrator privileges are required to install the USB device driver on Windows XP, Windows Vista, Windows 7, and Windows 10.
- 4) Appropriate FTDI drivers may need to be downloaded and installed from the website at <http://www.ftdichip.com/Drivers/D2XX.html>.
- 5) Ensure that all jumper shunts and switches are configured as shown in [Table 1](#), [Table 2](#), and [Table 3](#).
- 6) Configure the DC power supplies for 18V and disable their outputs.
- 7) Connect the grounds of each power supply together, and then connect this common ground to AGND on the MAX17841B EV kit.
- 8) Connect the first 18V supply between the PACK+ and PACK- PCB pads on the first MAX17843 EV kit.
- 9) Connect the second 18V supply between the PACK+ and PACK- PCB pads on the second MAX17843 EV kit.
- 10) Connect the six 2-wire blue crossover cables as described below:
  - Connect P1 on the MAX17841B EV kit to P6 on the first MAX17843 EV kit
  - Connect P2 on the MAX17841B EV kit to P5 on the first MAX17843 EV kit
  - Connect P2 on the first MAX17843 EV kit to P6 on the second MAX17843 EV kit
  - Connect P3 on the first MAX17843 EV kit to P5 on the second MAX17843 EV kit
- 11) Connect the single, 2-wire red loopback cable from P2 to P3 on the second MAX17843 EV kit.
- 12) Enable the DC power supply.
- 13) Start the MAX17843 EV kit software by opening its icon in the **Start | Programs** menu. The EV kit software automatically establishes a connection with the EV kit. Once the status bar at the bottom of the window displays **MAX17841 Detected** ([Figure 1](#)), proceed to the next step.
- 14) If checked, uncheck the **MAX17841 SHDN** checkbox in the upper left box ([Figure 1](#)).
- 15) Select the **Initialization** tab.
- 16) Click the **Wake Up** button ([Figure 2](#)).
- 17) Click the **Hello All** button ([Figure 2](#)).
- 18) Click the **Set First Address** button ([Figure 3](#)).
- 19) Verify that the **Device Addresses** grid contains two device addresses ([Figure 3](#)).
- 20) The EV kit is now ready for further evaluation.

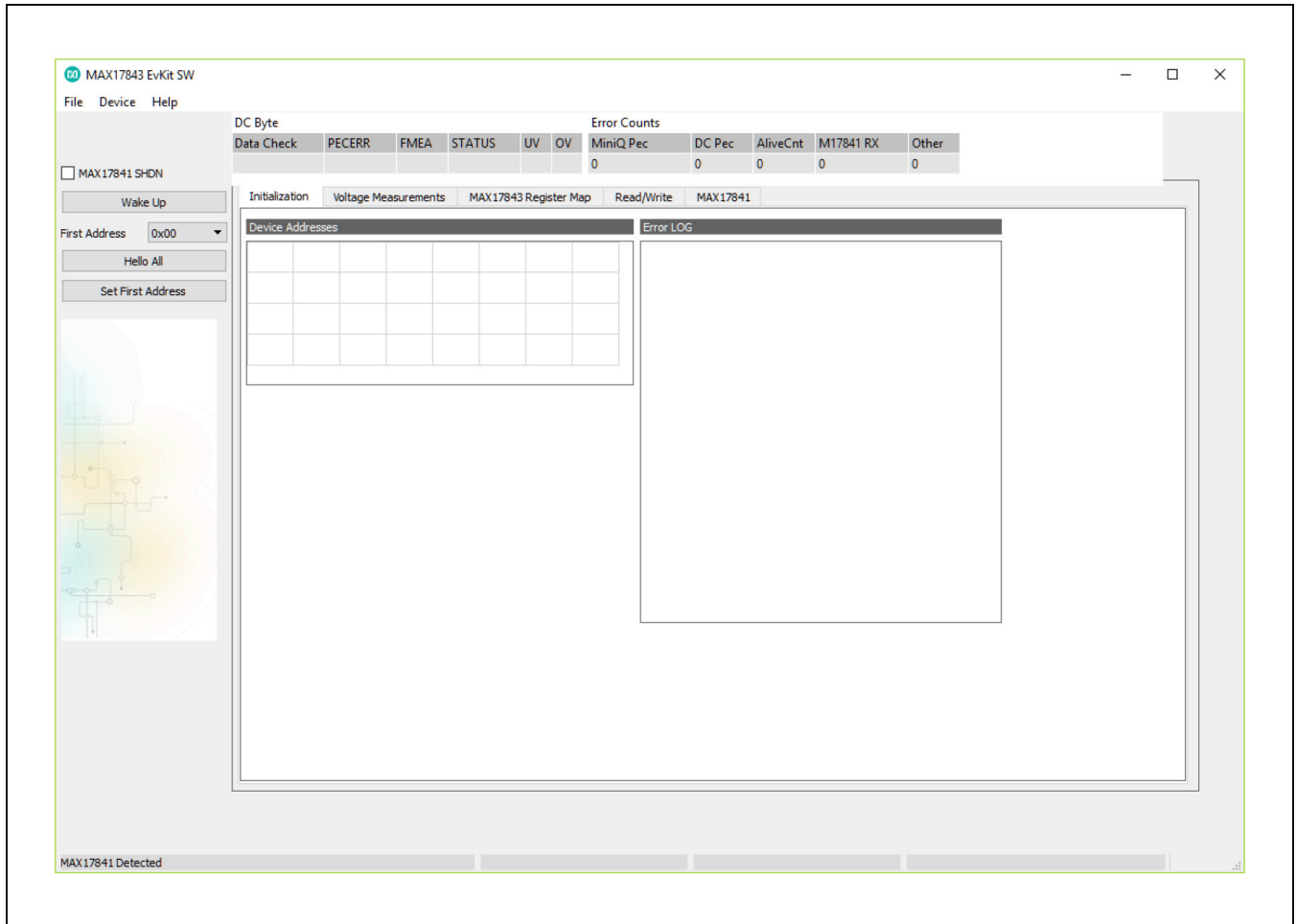

Figure 1. MAX17843 EV Kit Software (Installation Tab—MAX17841 Detected)

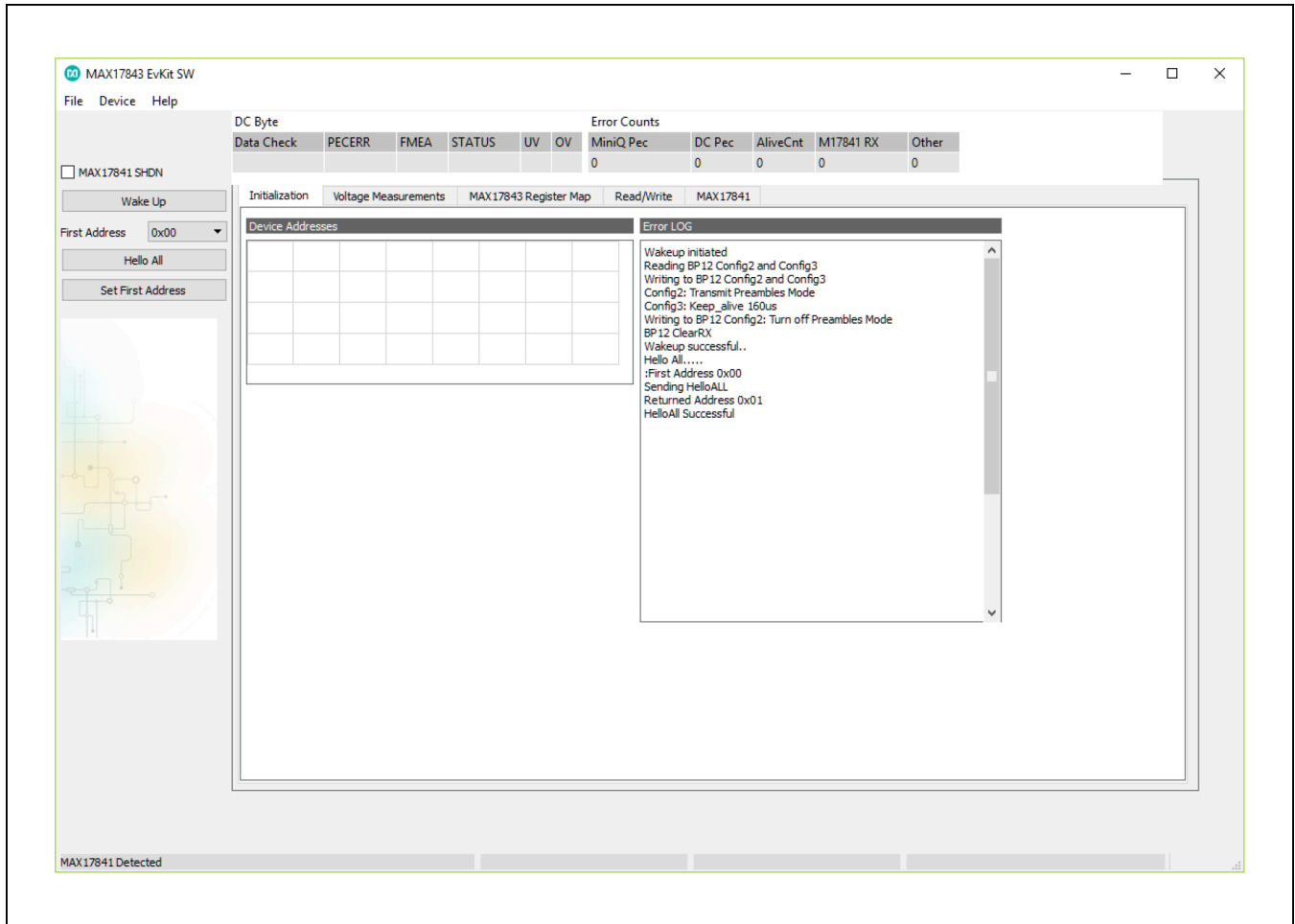

Figure 2. MAX17843 EV Kit Software (Installation Tab—Wake Up and Hello All)



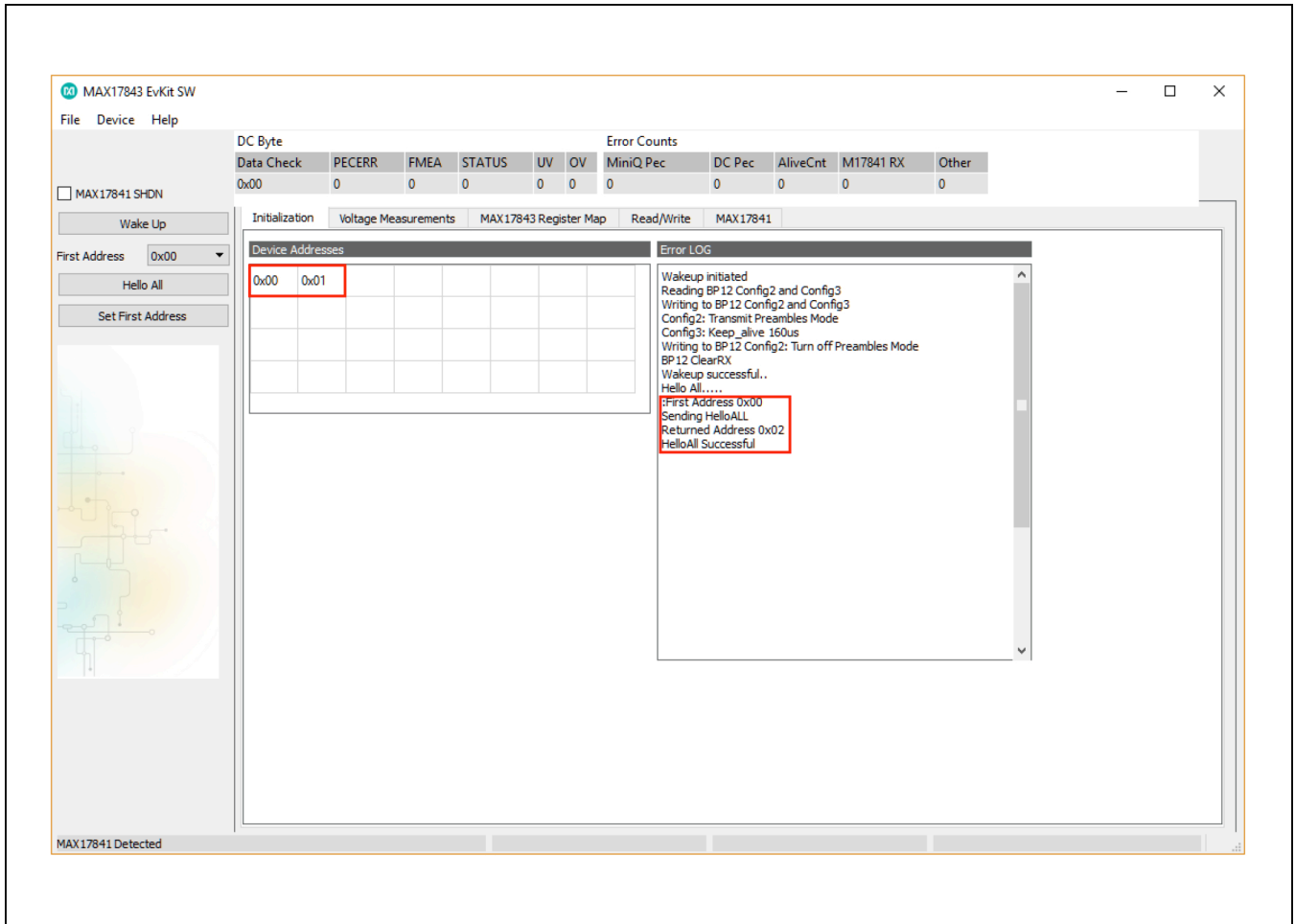

Figure 3. MAX17843 EV Kit Software (Installation Tab—Set First Address)

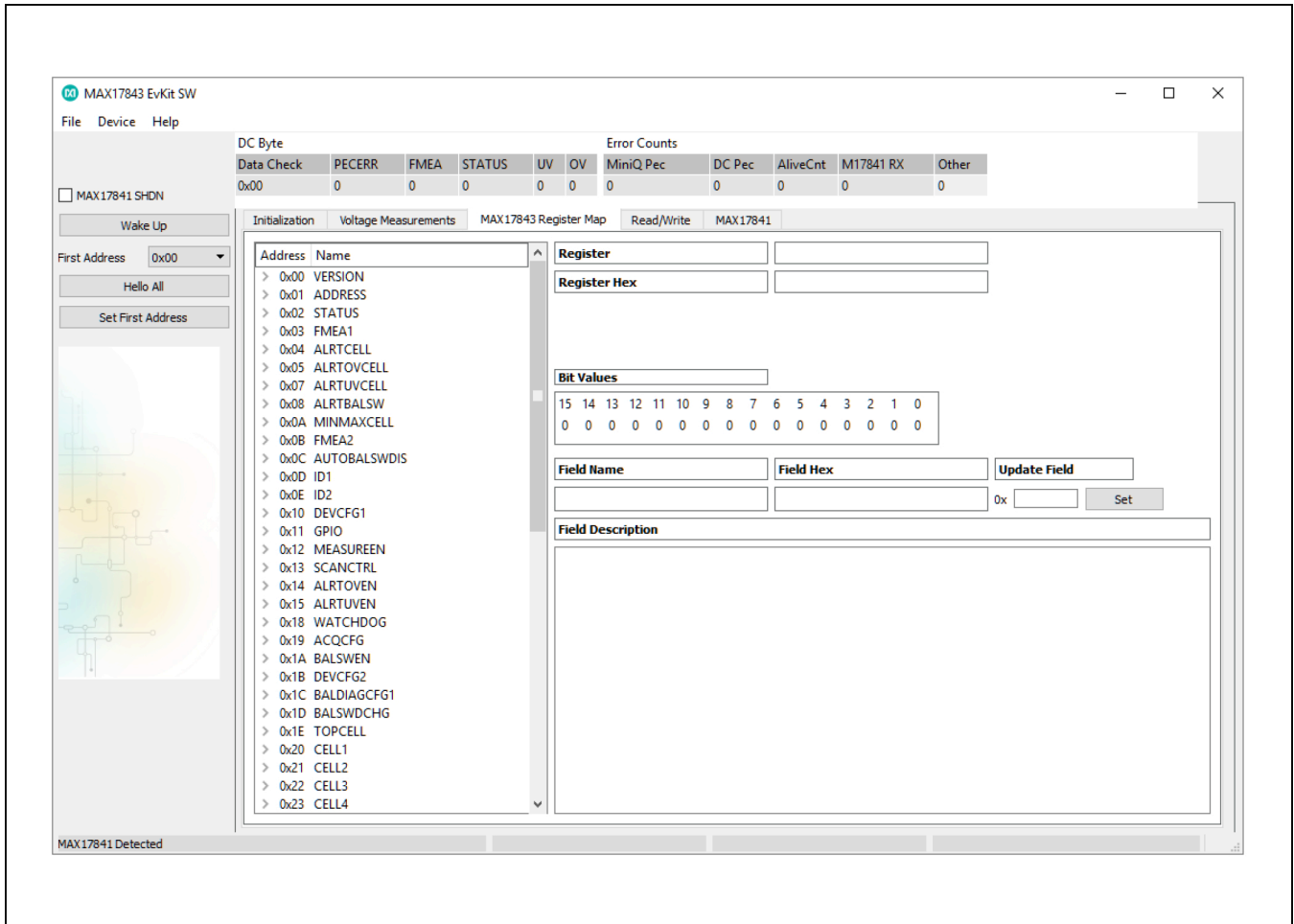

Figure 4. MAX17843 EV Kit Software (MAX17843 Register Map Tab)

**Table 1. MAX17843 EV Kit Default Jumper Settings**

JUMPER	SHUNT POSITION
JU0-JU3, JU15-JU18, CELL2-CELL12	On one pin only
JU14, JU19	Installed

**Table 2. MAX17841B EV Kit Default Jumper Settings**

JUMPER	SHUNT POSITION
JU1-JU4, JU6, JU7	On one pin only
JU5	1-2

**Table 3. MAX17843 EV Kit Quick Start Switch Settings**

SWITCH	SETTING
SW1	ON (actuators toward the top)

**Notes:**

- 1) The default position of SW1 is OFF (actuators towards the bottom) and this setup is for the battery input on P1.
- 2) The optional position of SW1 is ON (actuators towards the top) and this setup is for an external power-supply input between BAT0 and BAT12 with the 2kΩ resistor ladder.

### Detailed Description of Software

The MAX17843 EV kit is evaluated in conjunction with the MAX17843 graphical user interface (GUI) evaluation software. The GUI provides a friendly environment for reading and writing to all device registers, as well as executing several device commands. The GUI is divided into two sections: group boxes and command tabs.

The upper-left group box provides shutdown/enabling of the MAX17841B device, **Wake Up**, **Hello All**, and **Set First Address** buttons (Figure 1).

The **Initialization** tab (Figure 1) provides the **Device Address** grid and the **Error LOG** status box, which displays a summary of bus activity when the Wake Up and HELLOALL commands are executed. The **Error LOG** also provides descriptions of errors that occur during read, write, and scan operations.

The **Read/Write** tab (Figure 1) provides controls for executing the WRITEDEVICE, WRITEALL, READDEVICE, and READALL commands.

The **Voltage Measurements** tab (Figure 1) enables initiating and monitoring the ADC scanning of the connected devices.

The **MAX17843 Register Map** tab (Figure 1) provides a grid that is used to display the contents of the registers. This tab also includes bit-field descriptions for each register. The user can write to the registers of the first MAX17843 in the daisy-chain. Refer to the MAX17843 IC data sheet for additional register and interface details.

The **MAX17841** tab (Figure 1) provides access to the MAX17841B device registers, as well as bit-field information.

The software also provides a few functions to facilitate the evaluation process. These include the capability to save ADC measurements to a file, and the ability to save/load register configurations to/from a file. When evaluating the EV kit, the MAX17843 and MAX17841B IC data sheets should also be referenced for additional details.

### System Initialization

The MAX17843 EV kit daisy-chain is initialized using the controls provided in the main interface of the MAX17843 EV kit software GUI. The initialization sequence is provided below to begin operation:

- 1) Verify jumper configuration. See the *Device Startup* section.
- 2) Uncheck the **MAX17841 SHDN** checkbox (Figure 1).
- 3) Click the **Wake Up** button below the checkbox to execute a sequence that will wake up the MAX17843 devices in the daisy-chain.
- 4) Select the address of the first device in the daisy-chain from the **First Address** drop-down list above the **Hello All** button (Figure 2), which can usually be left as 0x00.
  - Refer to the *HELLOALL Command* section in the MAX17843 IC data sheet for additional details.
- 5) Click the **Hello All** button.
  - This command sends out the HELLOALL command, along with the chosen first device address. It also determines how many devices are in the daisy-chain based on the address byte that was returned by the last device.
- 6) Click the **Set First Address** button (Figure 3).
  - This control writes the address of the first device to the upper 8 bits of each device’s 16-bit ADDRESS register. This control uses the WRITEALL command. This control also updates the **Device Addresses** grid, as shown in Figure 3.

The daisy-chain has been initialized once all devices have been programmed with the address of the first device. The software is now fully operational, with all active devices configurable. Refer to the *UART Interface* section in the MAX17843 IC data sheet for additional configuration recommendations.

**Table 4. ADDRESS Register**

ADDRESS REGISTER ADDRESS							
BIT 7	BIT 6	BIT 5	BIT 4	BIT 3	BIT 2	BIT 1	BIT 0
0	0	0	0	0	0	0	1
ADDRESS REGISTER (UPPER 8 BITS)							
BIT 15	BIT 14	BIT 13	BIT 12	BIT 11	BIT 10	BIT 9	BIT 8
0	0	0	FA4	FA3	FA2	FA1	FA0
ADDRESS REGISTER (LOWER 8 BITS)							
BIT 7	BIT 6	BIT 5	BIT 4	BIT 3	BIT 2	BIT 1	BIT 0
0	0	0	DA4	DA3	DA2	DA1	DA0

### Grid Initialization

When the **Set First Address** sequence is complete, the software updates the grids on the **Device Addresses Grid** box (Figure 3).

### Device Addresses Grid

The **Device Addresses** grid is initialized after clicking the **Set First Address** button (Figure 3). The grid contains the addresses of all detected devices in the daisy-chain. For the two-device daisy-chain procedure with a start address of 0x00, the grid would be displayed as shown in Figure 3.

### Register Content

The **Read/Write** tab in the MAX17843 EV Kit Software GUI (Figure 5) includes a box that displays the contents of the selected device registers. This section is updated to contain 'n' number of rows, where 'n' equals the total number of detected devices.

For a two-device daisy-chain, the register content box is configured with two rows, as shown in Figure 5.

### Device Communication

The following sections describe the methods to read and write from the MAX17843 GUI. For information on how the commands are structured, refer to the MAX17843 IC data sheet.

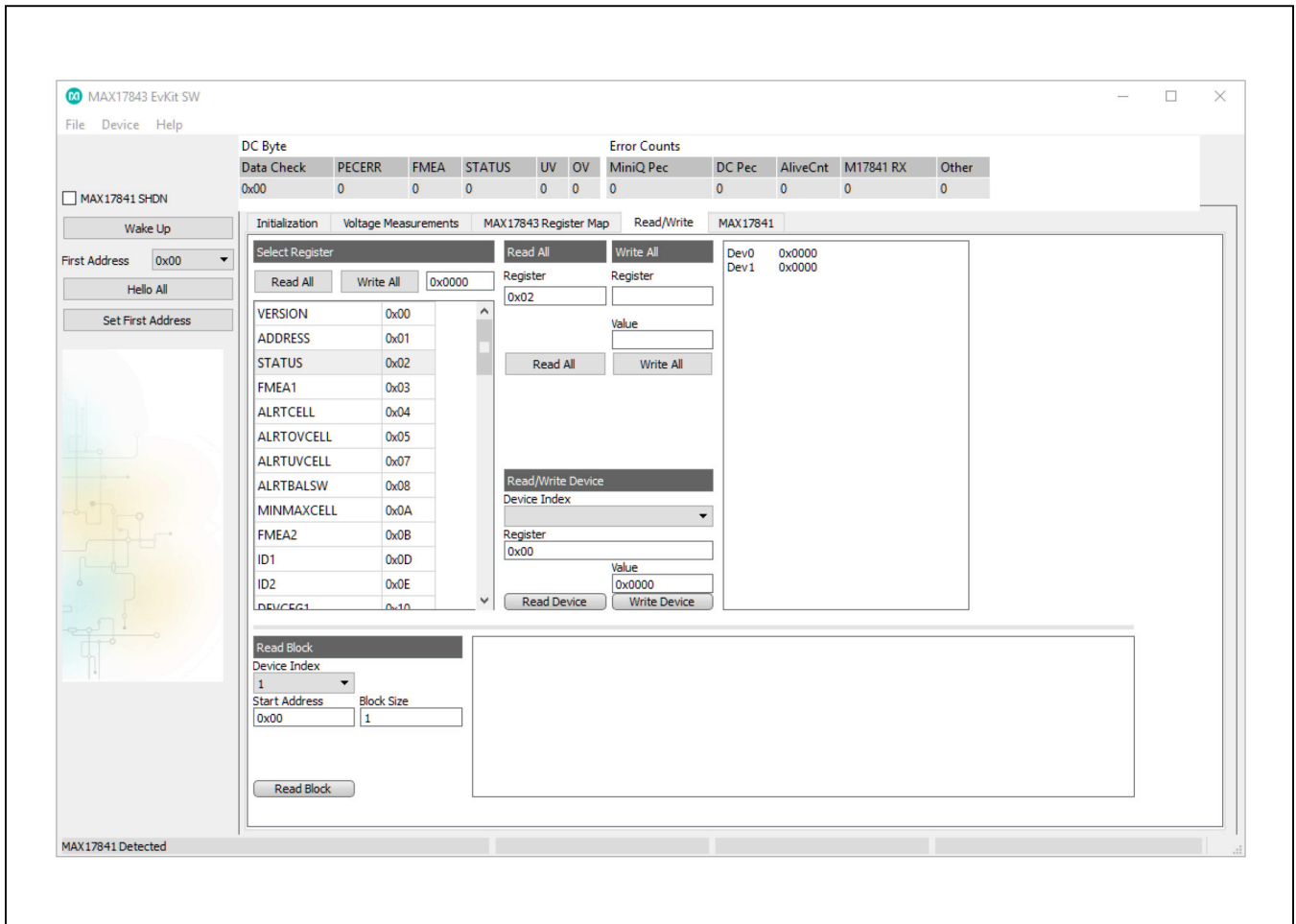

Figure 5. MAX17843 EV Kit Software (Read/Write Tab)

## Write Registers

A specific device in the daisy-chain can be written to by using the **Read/Write Device** section within the **Read/Write** tab shown in [Figure 5](#). To perform a write to a specific register of a single device:

- 1) Select the device to be written to from the **Device Index** drop-down list.
- 2) Enter the register address of the desired register to be written to in the **Register** edit box.
- 3) Enter the hex value (#####) into the **Value** edit box.
- 4) Click the **Write Device** button.

The **Read/Write** tab can also be used to write a desired value into the active register of all the devices in the daisy-chain. There are two options for performing a **Write All**. The first option is performed using the complete list of registers under the **Select Register** section ([Figure 5](#)).

- 1) Select the register to be written to from the complete list of registers by clicking on the name of the desired register.
- 2) Enter the hex value (#####) into the edit box directly to the right of the **Write All** button ([Figure 6](#)).
- 3) Click the **Write All** button ([Figure 6](#)).

The second option to perform a **Write All** uses the **Read All and Write All** section ([Figure 6](#)) of the **Read/Write** tab.

- 4) Select the register to be written to by entering its address in the **Register** edit box under **Write All** section.
- 5) Enter the hex value (#####) in the **Value** edit box directly above the **Write All** button.
- 6) Click the **Write All** button.

## Read Registers

A specific device in the daisy-chain can be read by using the **Read/Write Device** section within the **Read/Write** tab shown in [Figure 6](#). To perform a read of a specific register of a single device:

- 1) Select the device to read from the **Device Index** drop-down list.
- 2) Enter the address of the desired register to be read in the **Register** edit box.
- 3) Click the **Read Device** button.

The **Read/Write** tab can also be used to read the active register of all devices in the daisy-chain. There are two options for performing a **Read All**. The first option is performed by clicking the name of the desired register from the complete list of registers ([Figure 6](#)).

- 1) Click on the register to be read from.
- 2) Click the **Read All** button above the register list.

The second option for performing a **Read All** uses the **Read All and Write All** sections ([Figure 6](#)) in the **Read/Write Device** tab.

- 1) Select the register to be read by entering its address in the Register edit box under Read All section.
- 2) Click the Read All button.

Finally, a **Read Block** ([Figure 6](#)) is used to read multiple consecutive registers within a specified device. To perform a read of a specific set of registers of a single device:

- 1) Select the device to be read from the **Device Index** drop-down list.
- 2) Enter the address of the first register in the **Start Address** edit box.
- 3) Enter the desired amount of registers to be read in the **Block Size** field.
- 4) Click the **Read Block** button.

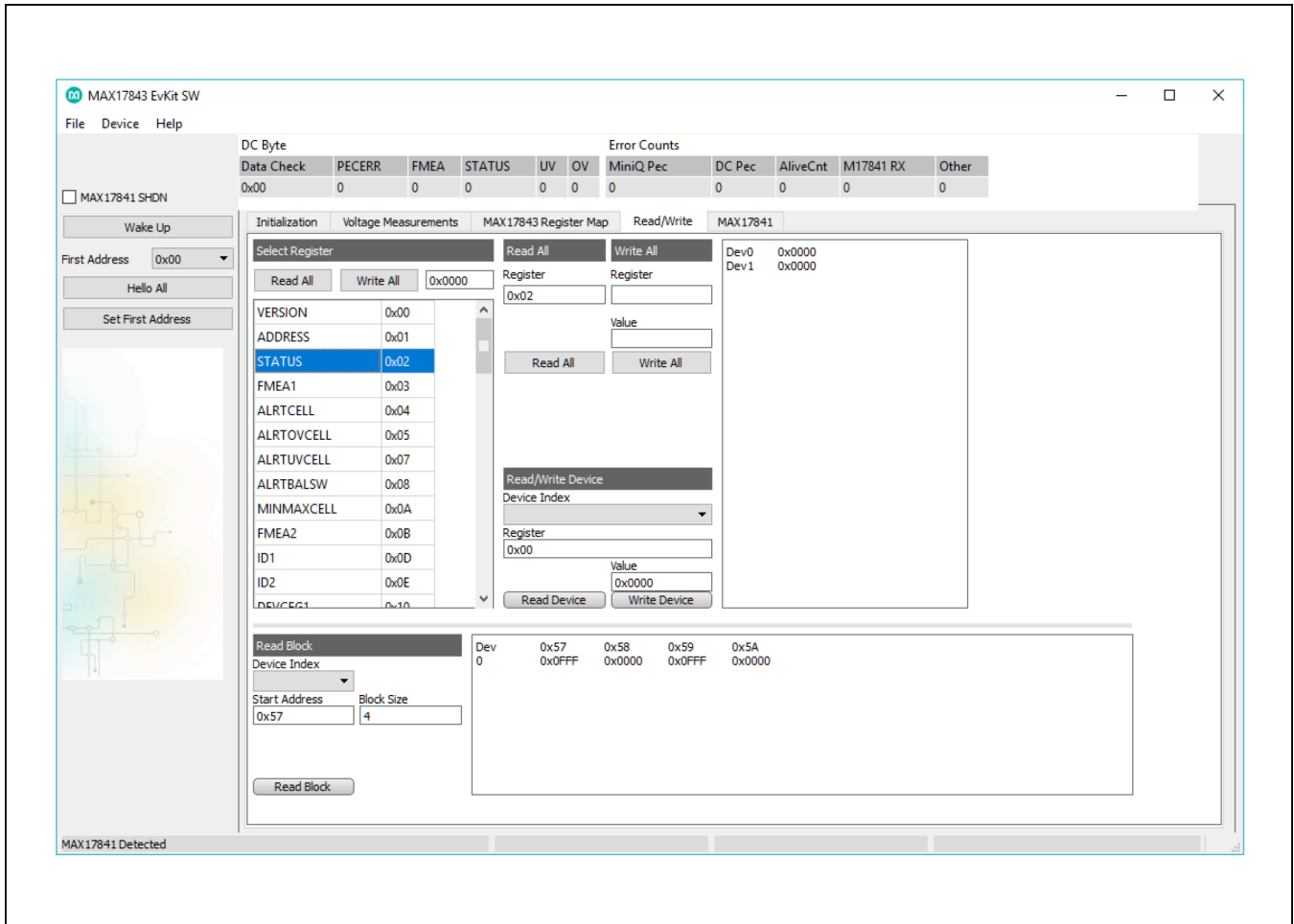

Figure 6. MAX17843 Evaluation Kit Software (Read/Write Tab—Select Register from List and Write All)

**Table 5. Read Controls**

CONTROL NAME	CONTROL TYPE	FUNCTION
Read Device	Button	Reads the active MAX17843 register of the active MAX17843 device.
Read All	Button	Reads the active MAX17843 register of all devices.

**Table 6. Scan Controls**

CONTROL NAME	CONTROL TYPE	FUNCTION
Start ADC Scanning	Checkbox	When checked, a scan of the ADC is initiated.
Single Scan	Button	Performs a single ADC scan.
Oversample Config	Drop-down list	Sets the desired number of oversampling.
Polarity	Drop-down list	Selects Unipolar or Bipolar mode.

### Register Tabs

The device registers are organized into two tabs: The **MAX17843 Register Map** tab and **Read/Write** tab. The **Read/Write Device** tab provides full access to read/write to each device in the daisy-chain, whereas the **MAX17843 Register Map** tab provides register and bit information and the ability to read/write to the first MAX17843 in the daisy chain.

### Voltage Measurements Tab

The **Voltage Measurements** tab (Figure 7) displays the results for the ADC conversions on cells 1–12, as well as the results from the TOTAL, MIN/MAX (cells with minimum and maximum voltage) , BLOCK, AIN1, AIN2, and DIAG registers. The **Enable All (MeasureEn)** button at the bottom-right side is used to enable ADC scanning of the associated measurement.

The scan section at the bottom-right side of the GUI provides controls for configuring the scan settings.

### STATUS Field

All device alerts are monitored under the STATUS field at the top of the MAX17843 EV Kit Software GUI (Figure 7). If a STATUS field is set to “1”, it indicates a device or associated external circuit error. This should be checked by reading the STATUS Register (0x02) from the **Read/Write** tab. The STATUS register read details what needs to be done in case of a STATUS flag. Refer to the MAX17843 IC data sheet for details on the STATUS register.

### Measurement and Voltage Alerts

**Alert Status (ALRTCELL, ALRTOVCELL, ALRTUV-CELL):** Refer to the **Measurement Alerts** and **Voltage Alerts** sections in the MAX17843 IC data sheet for additional information.

When performing a read of these alert registers, each alert must be cleared as described in the MAX17843 IC data sheet to continue with the evaluation.

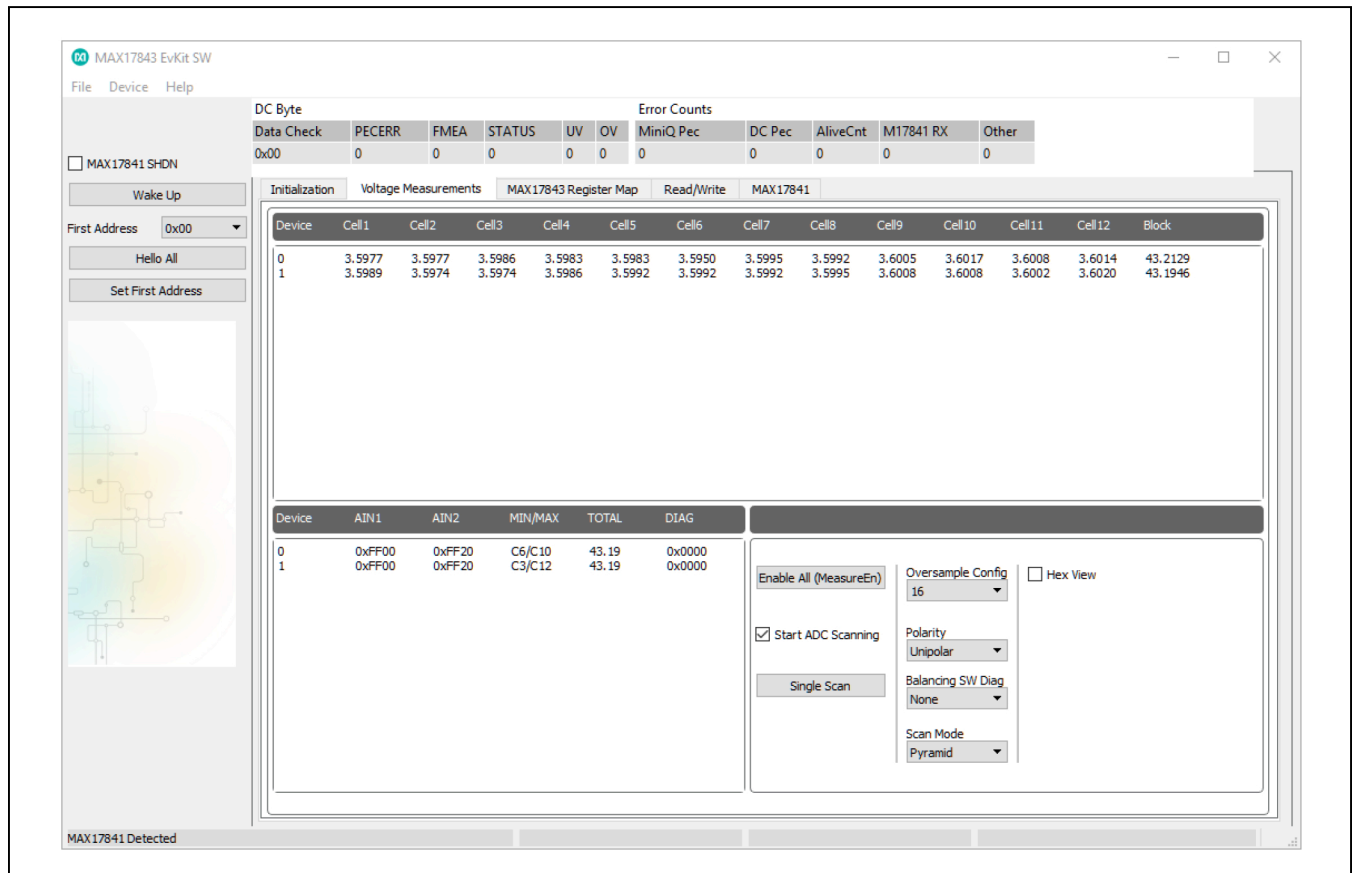

Figure 7. MAX17843 Evaluation Kit Software (Voltage Measurements Tab)

The undervoltage (ALRTUV) and overvoltage (ALRTOV) alerts can be individually enabled for any cell and auxiliary (AIN) input. The alert enables are in the ALRTOVEN (0x14) and ALRUVTEN (0x15) registers. The ALRTCELL Register Alerts (0x04) are generated from the results of ALRTOVCELL (0x05) or ALRTUVCELL (0x06) Registers. Thus, to disable an ALRTCELL alert, both the overvoltage and under voltage alerts for that cell must be disabled from ALRTOVEN Register (0x14) and ALRTUVEN Register (0x15) respectively.

### Configuration Settings

The configuration of different settings of the MAX17843 can be classified as follows (Table 7 lists the main configurations and their functions): General-Purpose I/O (GPIO), ADC Acquisition Time (ACQCFG), Watchdog Configuration (WATCHDOG), Device Configuration (DEVCFG), Measurement Enable (MEASUREEN), top cell (TOPCELL) and balancing switch discharge configuration (BALSWDCHG).

**Table 7. Configuration Settings**

<b>General-Purpose I/O (GPIO)</b>		
GPIO as Input	Register 0x11	Configures the GPIO pin as an input; bits D[15:12]
GPIO as Output	Register 0x11	Configures the GPIO pin as an output; bits D[15:12]
GPIO Logic State	Register 0x11	Displays current state of the GPIO pin; bits D[15:12]
<b>ADC Acquisition Time (ACQCFG)</b>		
Acquisition Time	Register 0x19	6-bit acquisition time for AUXIN1/AUXIN2
<b>Watchdog Configuration (WATCHDOG)</b>		
Timer Value	Register 0x18	Sets the cell-balancing timer
Timer Pre-divider	Register 0x18	Sets the step size of the cell-balancing timer
<b>Device Configuration (DEVCFG)</b>		
Scan Timeout	Register 0x13	Enables/disables the watchdog timeout
Packet Error Checking	Register 0x11	Enables/disables the packet error checking
Double Buffering	Register 0x10	Enables/disables double buffering of the measurement registers
ADC Data Path Test	Register 0x57 Register 0x58 Register 0x59 Register 0x5A	Enables/disables ADC data-path diagnostic test
Alive Counter	Register 0x10	Enables/disables alive counter
<b>Measurement Enable (MEASUREEN)</b>		
CELL1–CELL12	Register 0x12	Selects which cell to enable for measurement
Set All >>	Register 0x12	Enables all cells for measurement
Clear All >>	Register 0x12	Disables all cells for measurement
BLOCK	Register 0x12	Enables block-voltage measurement
AIN1, AIN2	Register 0x12	Selects which AUX (i.e., AUXIN1 or AUXIN2) to enable for measurement
<b>TOPCELL</b>		
TOPCELL Position	Register 0x1E	Configures the top cell position if less than 12 channels are used
<b>Balancing Switch Discharge (BALSWDCHG)</b>		
BALSWDCHG	Register 0x1D	Balancing Switch Discharge configuration



**BALSW**

Some of the BALSW configurations frequently used include: CELLTEST, BALSWEEN, balancing diagnostic (BALDIAGCFG1), and Balancing-Switch Thresholds (see [Table 8](#)).

**Model/Version/ADC Test**

The content of the device ADDRESS register (0x01) and device model VERSION (0x00) register can also be read.

You can read the ID1 (0x0D) and ID2 (0x0E) registers for verification of valid device IDs.

Model and Version Number: The lower nibble of the VERSION register (VER [3:0]) contains the IC’s die version number. The upper 12 bits (MOD [15:4]) contain the model number, which is set to 0x843 (1000 01000011). The VERSION register is a read-only register.

**Table 8. Cell and Balancing-Switch Controls**

<b>Cell Input Test Switches (CELLTEST)</b>		
CTSTEN0–CTSTEN12	Register 0x52	Enables unconnected cell-input detection
<b>Cell-Balancing Switch Enable (BALSWEEN)</b>		
BAL1–BAL12	Register 0x1A	Enables external cell balancing
<b>Balancing Diagnostic (BALDIAGCFG1)</b>		
CELLxxEN_M	Register 0x1C	Selects which cell to enable for measurement
Cell Input Mux Selection	Register 0x51	Selects multiplexer (HV-MUX, ALT-MUX)
Scan Polarity	Register 0x13	Selects ADC mode (unipolar, bipolar)
<b>Balancing-Switch Thresholds</b>		
Short-Circuit Threshold	Register 0x4B	Sets the threshold voltage
Voltage Low Threshold	Register 0x4C	Sets the threshold voltage
Voltage High Threshold	Register 0x4D	Sets the threshold voltage

**Table 9. VERSION Register**

<b>BIT 15</b>	<b>BIT 14</b>	<b>BIT 13</b>	<b>BIT 12</b>	<b>BIT 11</b>	<b>BIT 10</b>	<b>BIT 9</b>	<b>BIT 8</b>
1	0	0	0	0	1	0	0
<b>BIT 7</b>	<b>BIT 6</b>	<b>BIT 5</b>	<b>BIT 4</b>	<b>BIT 3</b>	<b>BIT 2</b>	<b>BIT 1</b>	<b>BIT 0</b>
0	0	1	1	VER [3:0]			

**ADC Scan**

An ADC scan measures all enabled cell inputs, all enabled auxiliary inputs, and the self-diagnostics channel (if enabled). The acquisition is completed once the SCANDONE bit in the SCANCTRL register is set. The DEVCFG1 register (0x10) is used to configure which ADC is selected. The default is the ADC1. ADC2 can be selected from ADCSELECT bit in DEVCFG1 register (0x10). The following procedure outlines the steps to set up and initiate single or continuous ADC scanning.

**Setup:**

- Enable the cells to measure
- Enable the self-diagnostics and auxiliary inputs to measure

**Initiate a Single ADC Scan (Figure 8):**

- Select the Voltage Measurements tab
- Click the Single Scan button

**Note:** The SCANDONE bit is automatically set before a read is done on the **Voltage Measurements** tab

**Initiate Continuous ADC Scanning (Figure 9):**

- Select the Voltage Measurements tab.
- Check the Start ADC scanning checkbox.

**Note:** To save the data during a continuous ADC scan, perform the steps in the Log Scanned Data section.

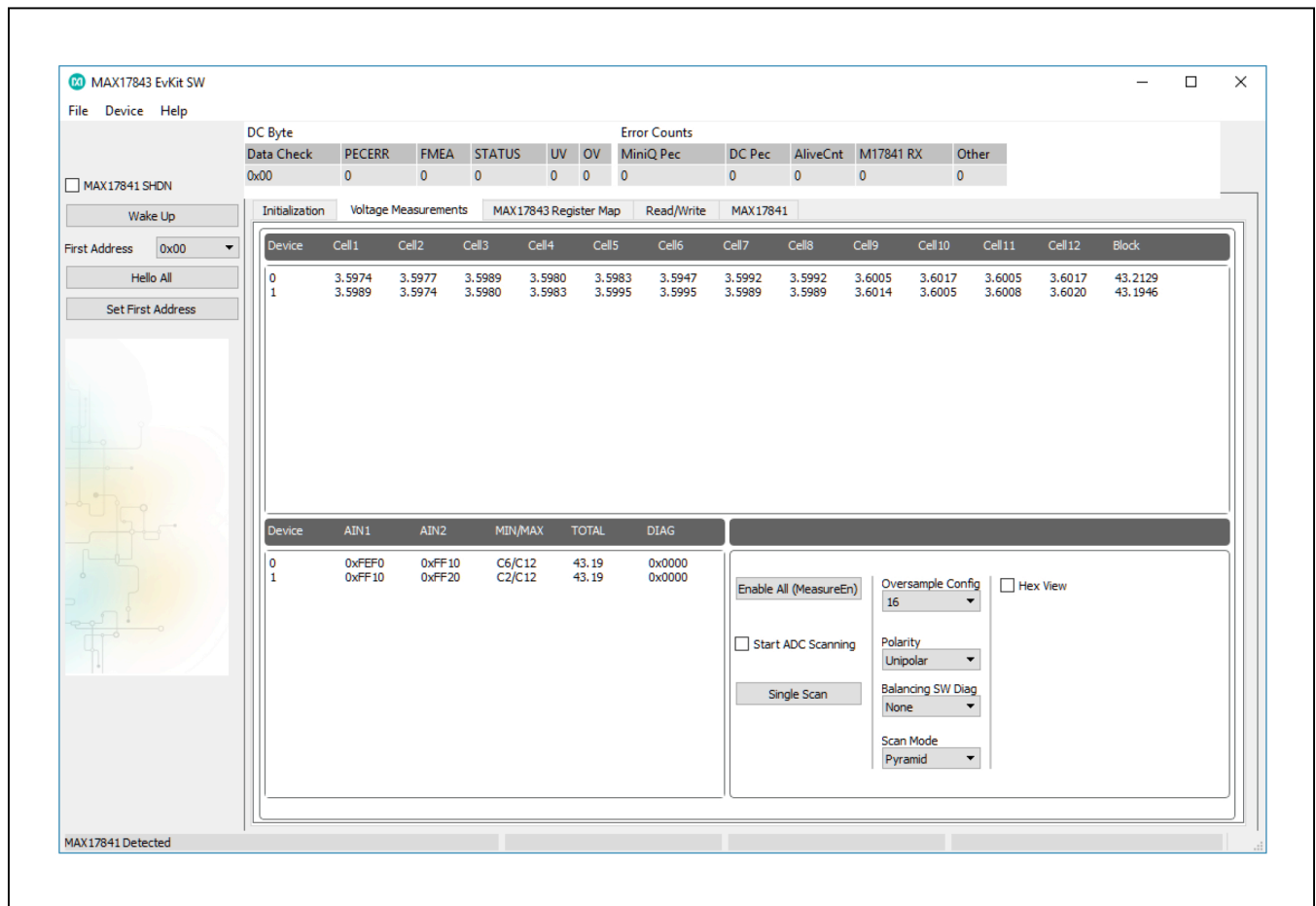

Figure 8. MAX17843 Evaluation Kit Software (Voltage Measurements Tab—Single Scan)

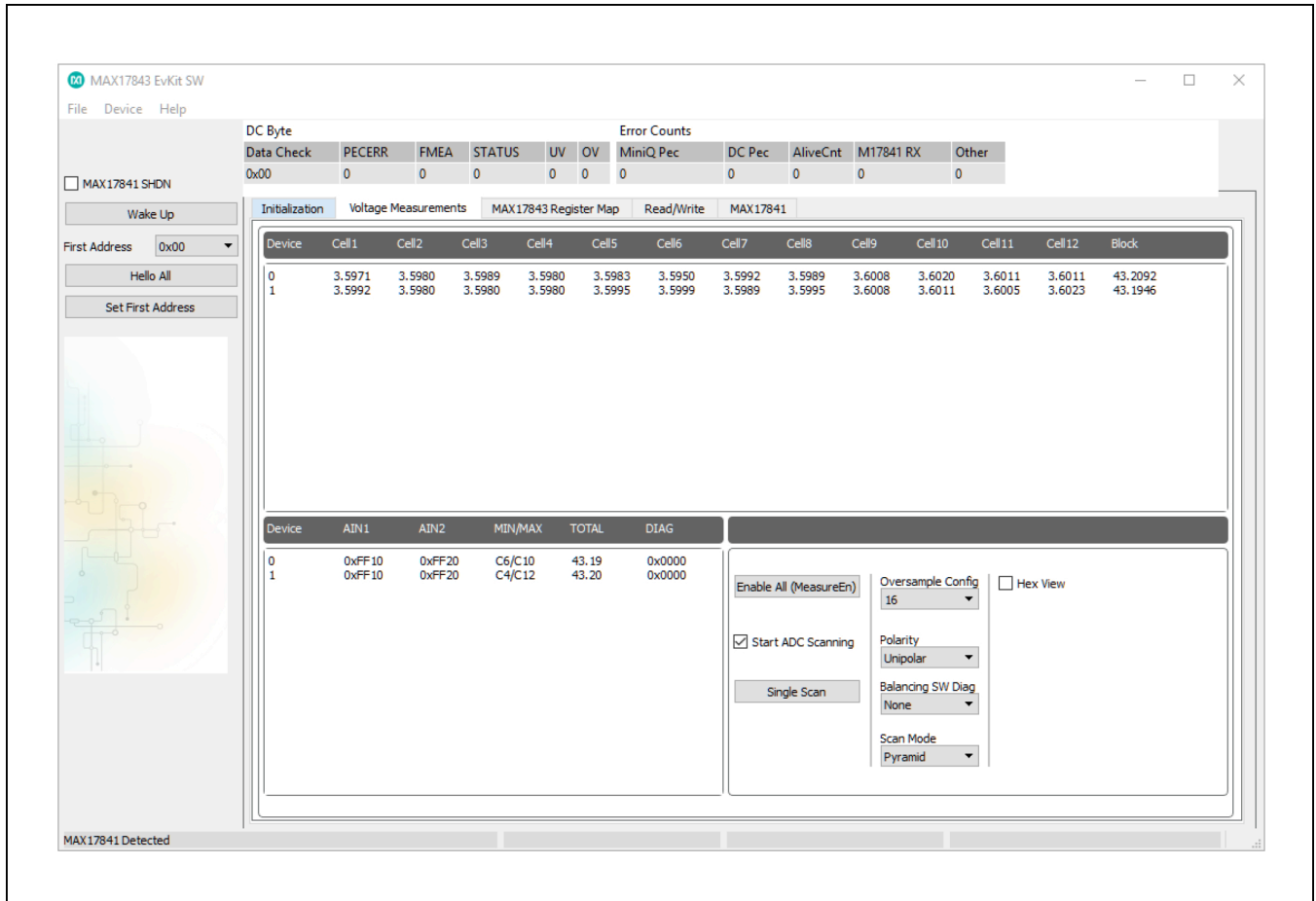

Figure 9. MAX17843 Evaluation Kit Software (Voltage Measurements Tab—Start ADC Scanning)

**Log Scanned Data**

The MAX17843 EV kit software allows the data measured during continuous ADC scanning to be saved to file. This feature is available by selecting the **File | Log Scan Data** menu item. The steps below explain how to setup data logging:

- Perform the steps listed in the *ADC Scan* section.
- Select the **File | Log Scan Data** menu item. The window shown in [Figure 10](#).

- Enter the number of ADC scans to log and the file path and root name ([Figure 11](#)), then click the **OK** button.
- Once n number of scans has completed, data can be retrieved from the **File Path** location. The file name is appended with date and time stamp.

At the completion of this process, data logging is disabled, but the continuous ADC scanning continues until the **Start ADC Scanning** checkbox is unchecked. The file generated by the software logs the measured data of the enabled channels for all devices in the daisy-chain.

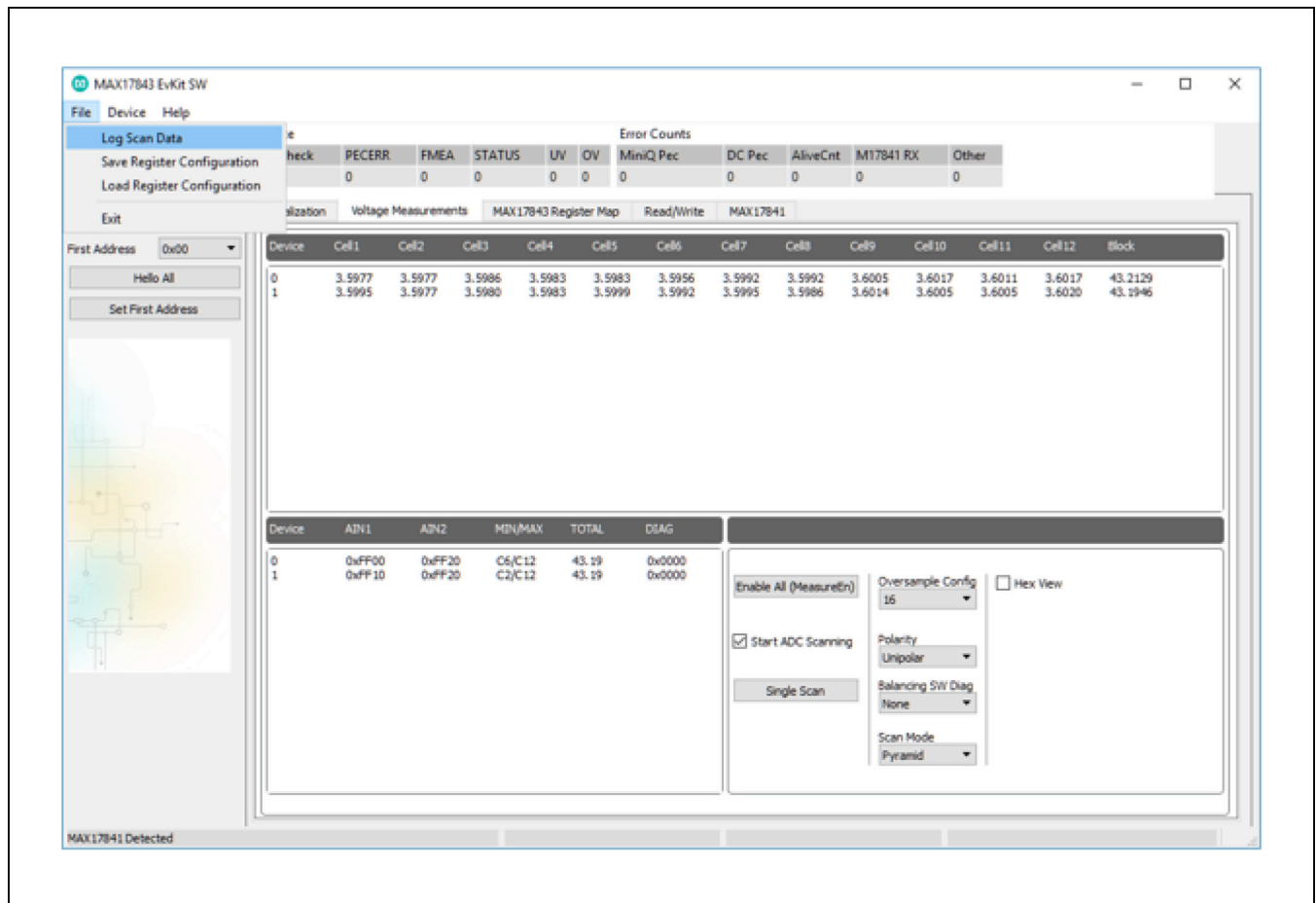

Figure 10. MAX17843 Evaluation Kit Software (File Menu Item—Log Scan Data)

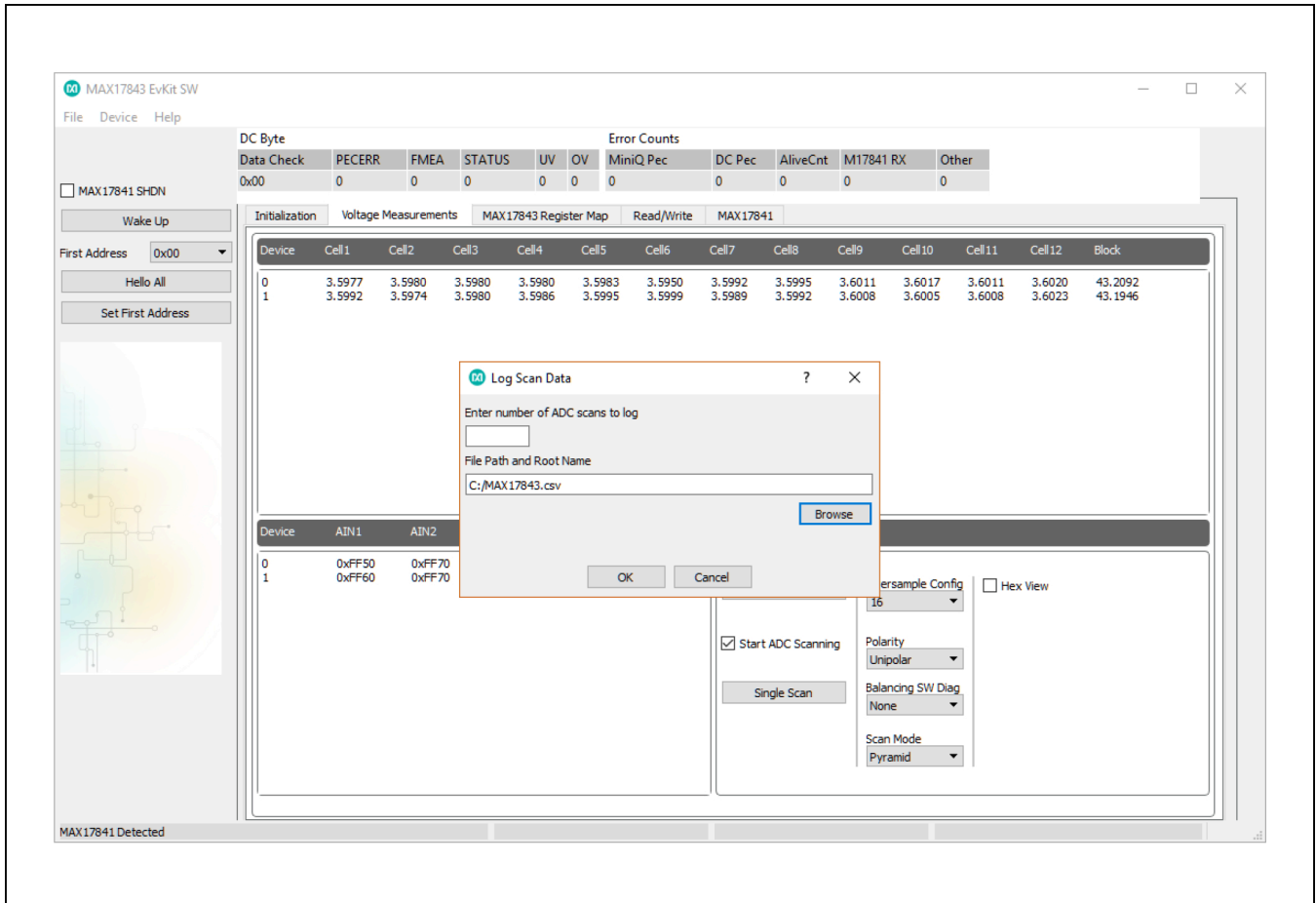

Figure 11. MAX17843 Evaluation Kit Software (Voltage Measurements Tab—Enter Number of Scans and Choose File Path Dialog Box)

### Save/Load Register Configuration

The GUI features a **Save Register Configuration** and **Load Register Configuration** function. This allows all current register configurations and GUI control settings to be saved and loaded later. When saving, the software first performs a read of all the registers of each device in the daisy-chain to obtain their current configurations. Once complete, a **Save All Data** dialog box appears (Figure 12) asking for a file name and type. When loading, a **Load Configuration** file window appears asking for a file to open. The load function writes the data from the file to the registers of all the devices in the daisy-chain.

### PEC Byte

The MAX17843 EV kit software supports packet-error-checking (PEC) display by implementing a CRC-8 algorithm to maintain data integrity with the devices in the daisy-chain. The software generates the PEC byte when performing a write to a MAX17843 device and verifies the PEC byte received from the devices after a read operation. For details on how to make a PEC calculation, refer to *PEC Errors* section in the MAX17843 IC data sheet.

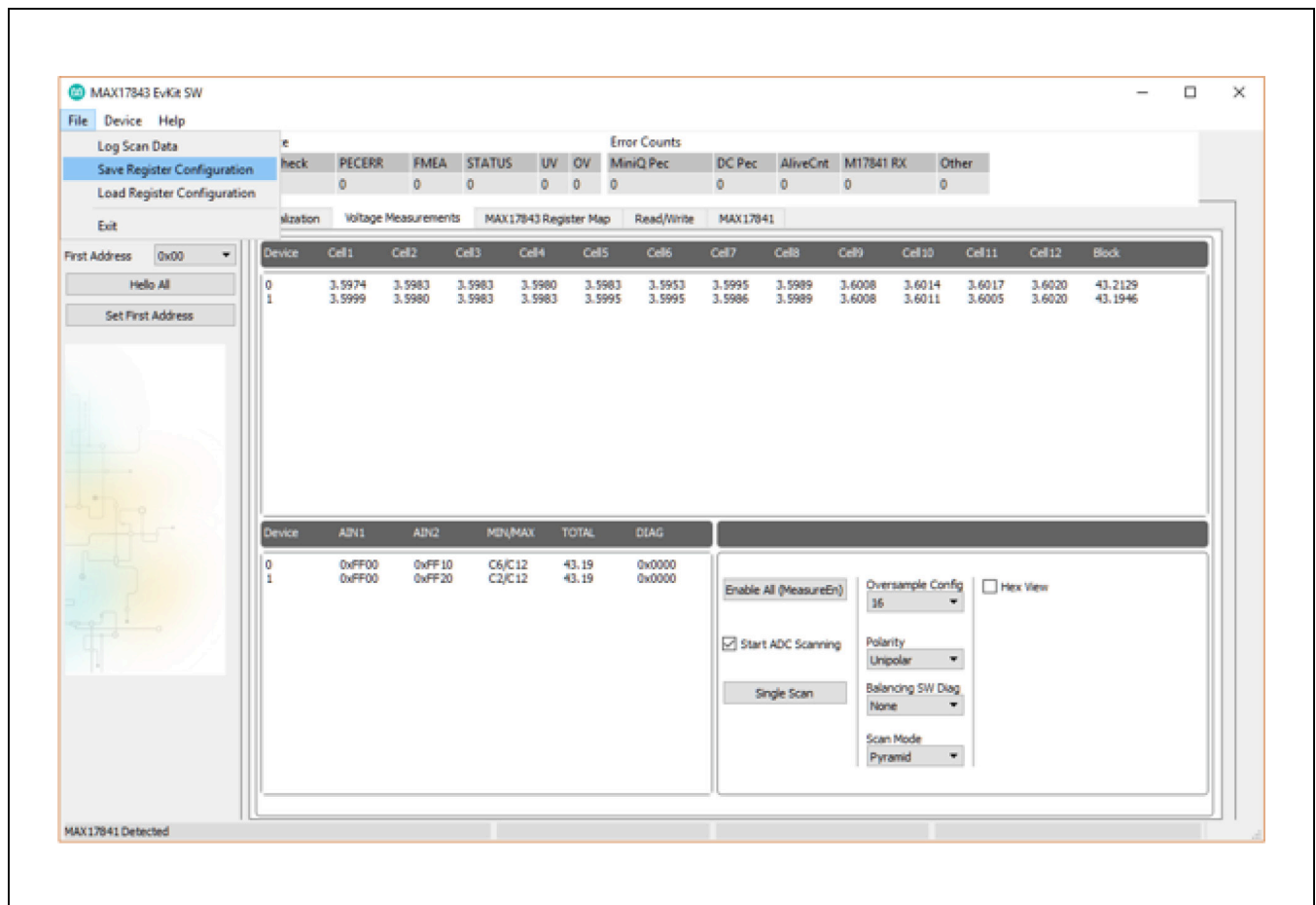

Figure 12. MAX17843 Evaluation Kit Software (Voltage Measurements Tab—Save/Load Register Configuration)

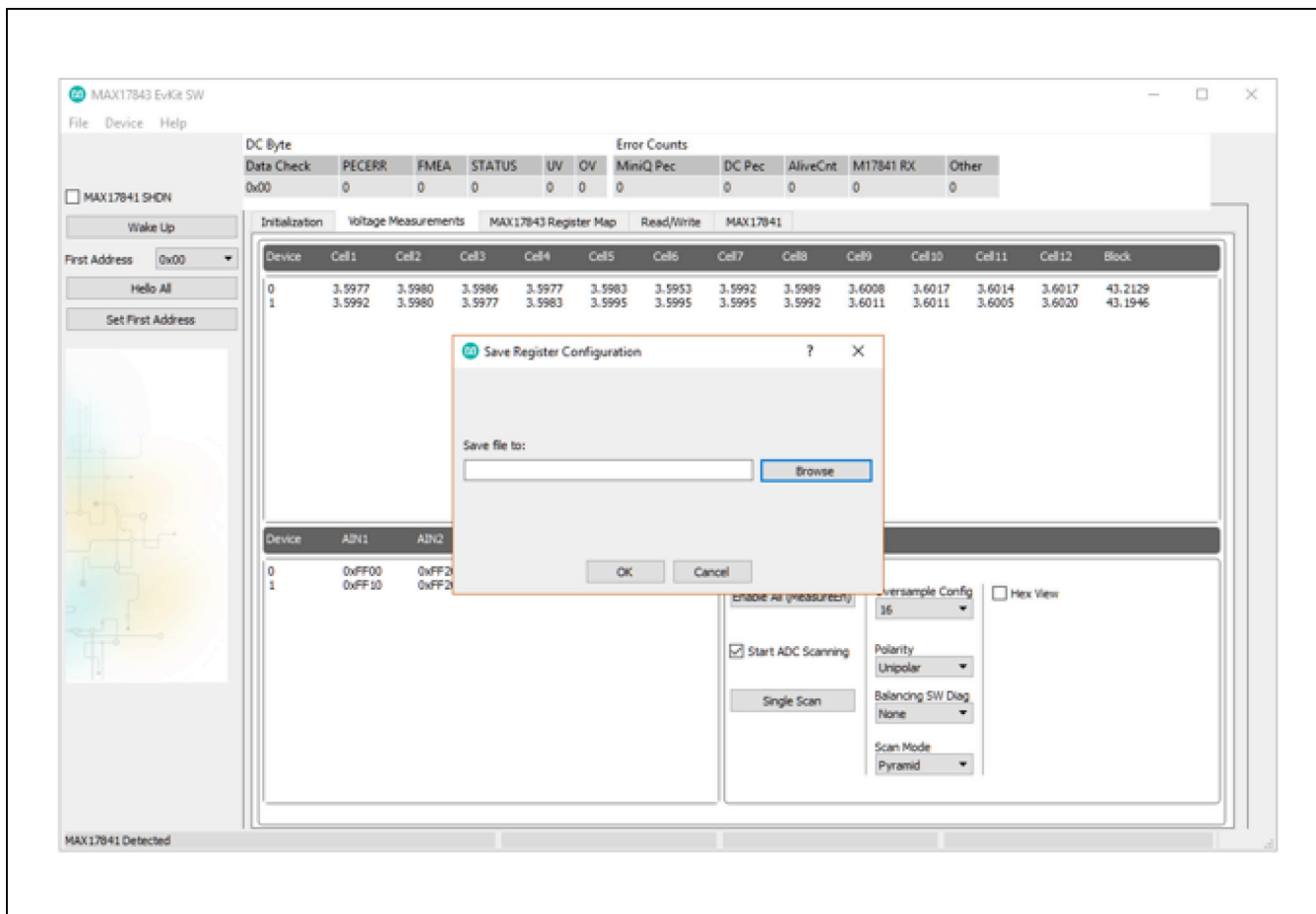

Figure 13. MAX17843 Evaluation Kit Software (Voltage Measurements Tab—Save Register Configuration Dialog Box)

### Detailed Description of Hardware

The MAX17843 evaluation kit (EV kit) demonstrates the capabilities of the MAX17843 12-channel, high-voltage smart sensor data-acquisition interface IC. Vertical headers (P2–P6) allow for the connection of multiple EV kits, supporting a 32-device (max) daisy-chain capability.

The MAX17843 device can be configured to operate with 3–12 battery cells. The cells can be directly connected to the EV kit, or can be routed through the P1 header. See the *Battery Cells* section. The EV kit also facilitates utilizing the auxiliary pins and accessing the general-purpose input/output (GPIO) pins.

### Device Startup

To start up the EV kit, apply 9V (min) across the PACK+ and PACK- PCB pads and then follow the startup sequence below:

- 1) Connect the six, 2-wire, blue crossover cables, as follows:
  - Connect P1 on the MAX17841B EV kit to P6 on the first MAX17843 EV kit.
  - Connect P2 on the MAX17841B EV kit to P5 on the first MAX17843 EV kit.
  - Connect P2 on the first MAX17843 EV kit to P6 on the second MAX17843 EV kit.
  - Connect P3 on the first MAX17843 EV kit to P5 on the second MAX17843 EV kit.
- 2) Connect the single, 2-wire red loopback cable from P2 to P3 of the second MAX17843 EV kit.
- 3) Connect a pack voltage across the PACK+ and PACK- pads.
- 4) Connect a battery voltage across the BAT0–BAT12 pads (battery cells or external power supply).

- 5) Connect the MINIQUSB command module to the MAX17841B EV kit’s J3 and J4 headers.
- 6) Using the provided USB cable, connect the MINIQUSB command module to a PC.
- 7) Start the MAX17843 EV kit software.
- 8) Ensure that the MAX17841 SHDN checkbox ([Figure 1](#)) on the MAX17843 software GUI is not checked.
- 9) Click the **Wake Up** button in the MAX17843 software.

**Note:** The MAX17841B’s  $\overline{\text{SHDN}}$  pin is pulled up to +3.3V by the MINIQUSB’s K1 GPIO pin.

Once the wake-up routine is completed, the SHDN pin of each MAX17843 device on the daisy-chain should rise to approximately 8.5V. The devices are now enabled and ready for communication.

### Battery Cells

When evaluating the MAX17843 EV kit, the cell-stack voltage is provided by cascading 3–12 battery cells, or by applying a DC voltage between the BAT0–BAT12 pads. The following sections explain how to configure the EV kit and connect the battery cells.

### Cell Configuration

- 1) Configure switch SW1 according to [Table 10](#).
- 2) When using a DC power supply, the cascaded 2kΩ resistors provide divided-down voltages to the cell input pins. This, in effect, emulates the connection of 12 battery cells.
- 3) Configure jumpers CELL2–CELL12 according to the number of battery cells (actual or emulated) connected to the system (see [Table 11](#)).

**Table 10. Switch Descriptions (SW1)**

SW1	CELL-STACK VOLTAGE	CONNECTION
All off*	2–12 battery cells	Cells cascaded between BAT0-BAT12
All on	DC power supply to emulate battery	See step 10 in the Quick Start, Procedure section

\*Default position.



**Table 11. Jumper Descriptions (CELL2–CELL12)**

NO. OF CELLS	SHUNT POSITION										
	CELL 2	CELL 3	CELL 4	CELL 5	CELL 6	CELL 7	CELL 8	CELL 9	CELL 10	CELL 11	CELL 12
3	Off	Off	On	On	On	On	On	On	On	On	On
4	Off	Off	Off	On	On	On	On	On	On	On	On
5	Off	Off	Off	Off	On	On	On	On	On	On	On
6	Off	Off	Off	Off	Off	On	On	On	On	On	On
7	Off	Off	Off	Off	Off	Off	On	On	On	On	On
8	Off	Off	Off	Off	Off	Off	Off	On	On	On	On
9	Off	Off	Off	Off	Off	Off	Off	Off	On	On	On
10	Off	Off	Off	Off	Off	Off	Off	Off	Off	On	On
11	Off	Off	Off	Off	Off	Off	Off	Off	Off	Off	On
12*	Off	Off	Off	Off	Off	Off	Off	Off	Off	Off	Off

\*Default position.

### Cell Connections

When using actual or emulated battery cells, keep in mind the following cell-connection requirements (see [Table 12](#) for an 8-cell example):

- 3 cells (min) must be connected to each MAX17843 device
- 12 cells (max) can be connected to each MAX17843 device
- The BAT0\_ to BAT1\_ cell inputs must always be populated with a battery cell
- The remaining cells are populated between BAT 1\_ and BAT 2\_, BAT 2\_ and BAT 3\_, and so on, until all cells are connected
- All unused cell inputs must be shorted together, using the appropriate CELL2–CELL12 jumpers

When DC power supplies are used to emulate battery cells, set their output in the 9V to 60V range. Connect the power supplies between the PACK+ and PACK- PCB pads and ensure that a shunt is installed on jumpers JU14 and JU19.

When using actual battery cells, connect them across the appropriate BAT PCB pads, or route them through the P1 connector (see [Table 13](#)).

**Table 12. 8-Cell Connections**

CELL	+ TERMINAL	- TERMINAL
1	BAT1_	BAT0_
2	BAT2_	BAT1_
3	BAT3_	BAT2_
4	BAT4_	BAT3_
5	BAT5_	BAT4_
6	BAT6_	BAT5_
7	BAT7_	BAT6_
8	BAT8_	BAT7_
—	BAT9_ shorted to BAT8_	
—	BAT10_ shorted to BAT9_	
—	BAT11_ shorted to BAT10_	
—	BAT12_ shorted to BAT11_	

**Daisy-Chain**

The MAX17843 EV kit includes a UART bus system that allows cascading of up to 32 MAX17843 devices. The EV kit facilitates the device cascading by routing the UART bus between the P2/P3 and P5/P6 connectors. These connectors are used to cascade multiple EV kit boards together. Table 14 provides the pinouts for the inter board connectors on the EV kit.

**Auxiliary Inputs**

The auxiliary inputs of the MAX17843 devices are routed to jumpers JU0 and JU1. This allows the auxiliary analog inputs to measure external resistance-temperature detector (RTD) components. A negative temperature coefficient (NTC) RTD can be configured with the AUXIN1 or AUXIN2 analog inputs to accurately monitor module or battery-cell temperature. When the auxiliary inputs are not used, a shunt can be installed on its associated jumper, providing a known pin state (AGNDA).

**Maxim Command Module (MINIQUSEB)**

The MINIQUSEB module is powered by the host PC’s USB port. Refer to the MINIQUSEB User Guide for additional information. See Table 19 for a pin-to-pin association between the MINIQUSEB module and the EV kit’s J3 header.

**Table 13. P1 Header Cell Connections**

CELL	+ TERMINAL	- TERMINAL
1	P1-1	P1-3
2	P1-3	P1-5
3	P1-5	P1-7
4	P1-7	P1-9
5	P1-9	P1-11
6	P1-11	P1-13
7	P1-13	P1-15
8	P1-15	P1-17
9	P1-17	P1-19
10	P1-19	P1-21
11	P1-21	P1-23
12	P1-23	P1-25

**Table 14. Headers (P2/P3, P5/P6)**

PIN	NET
<b>P2 HEADER</b>	
1	TXUP_A
2	TXUN_A
<b>P3 HEADER</b>	
1	RXUP_A
2	RXUN_A
<b>P5 HEADER</b>	
1	TXLN_A
2	TXLP_A
<b>P6 HEADER</b>	
1	RXLN_A
2	RXLP_A

**Table 15. Auxiliary Jumpers (JU0, JU1)**

AUXILIARY INPUT (DEVICE)	JUMPER*
AUXIN1A (U1)	JU0
AUXIN2A (U1)	JU1

\*To use the auxiliary input, remove the shunt from the jumper.

**Table 16. MAX17841B EV Kit J3 Header**

PIN	NAME
1	GND
2	INT
3	GPIO7
4	COMP_OUT
5	GPIO8
6	ALRMUV
7	DIN
8	ALRMOV
9	CS
10	MCLR
11	SCLK
12	USHDN
13	DOUT
14	NC
15	VDD
16	NC

### 16-Pin Header Footprints

Table 20 provides the complete pinouts for each of the 16-pin single-row headers (J1–J4) provided on the MAX17842 EV kit. Between the headers is a MAX17843 device that is fanned out to the four 16-pin headers.

### J4 and J5 Headers

The J4 and J5 header footprints provide direct access to the MAX17843 IC.

**Table 17. MAX17843 EV Kit Headers (J1–J4)**

PIN NO.	PIN NAME			
	J1	J2	J3	J4
1	NC1	GPIO0	SW0	SW8
2	AGND	NC	C0	C8
3	SHDNL	NC19	SW1	SW9
4	AGND	TXLP	C1	C9
5	VAA	TXLN	SW2	SW10
6	TXUN	VDDL2	C2	C10
7	TXUP	AGND/GNDL2	SW3	SW11
8	AGND/GNDL1	RXLP	C3	C11
9	VDDL1	RXLN	SW4	SW12
10	AGND/GNDL3	NC26	C4	C12
11	VDDL3	NC27	SW5	VBLKP
12	RXUN	CTG	C5	NC60
13	RXUP	AUXIN2	SW6	HV
14	GPIO3	AUXIN1	C6	DCIN
15	GPIO2	AGND	SW7	CPP
16	GPIO1	THRM	C7	CPN

### Test Procedures

For all diagnostics and other testing details, refer to MAX17843 IC data sheet. Following are various test procedures for guidance.

#### A. Overvoltage- and Undervoltage-Threshold Testing

With the ASIC communicating normally to the host in a single ASIC configuration, configure the OV and UV set and clear thresholds in the threshold registers (OVTHSET and UVTHSET) of MAX17843 and check if the appropriate alerts are set. The detailed procedures follow (also see [Figure 14](#) and [Table 12](#)).

A variable 80V, 10A power supply is used to power up the MAX17843; the module voltage was initially set to 36V (3V/cell).

##### Test Procedure:

- 1) ASIC ready to measure (cell-measurement channels enabled, device addresses configured).
- 2) Start measurement.
- 3) Read cell voltages.
- 4) Enable alerts for all cells in ALRTOVEN and ALRTUVEN registers.
- 5) Confirm cell voltages are as expected by clicking **Single Scan** button in the **Voltage Measurements** tab on the screen.
- 6) Confirm that STATUS, ALRTCELL, ALRTOVCELL, and ALRTUVCELL registers read 0x0000 by reading the register values.

- 7) Either import or set the following configuration in the **Read/Write Device** tab:
  - OVTHSET (Overvoltage Set) configured to 4.2V (Hex = 0xD708).
  - OVTHCLR (Overvoltage Clear) configured to 3.8V (Hex = 0xC28C).
  - UVTHSET (Undervoltage Set) configured to 2.4V (Hex = 0x7AE0).
  - UVTHCLR (Undervoltage Clear) configured to 2.7V (Hex = 0x8A3C).
  - Some voltage thresholds and their corresponding hexadecimal conversion are given for reference (see [Table 21](#)).

**Table 18. Voltage Thresholds**

VOLTAGE THRESHOLD (V)	HEXADECIMAL
1.0	3330
1.5	4CCC
2.0	6664
2.5	8000
3.0	9998
3.5	B330
4.0	CCCC
4.5	D708

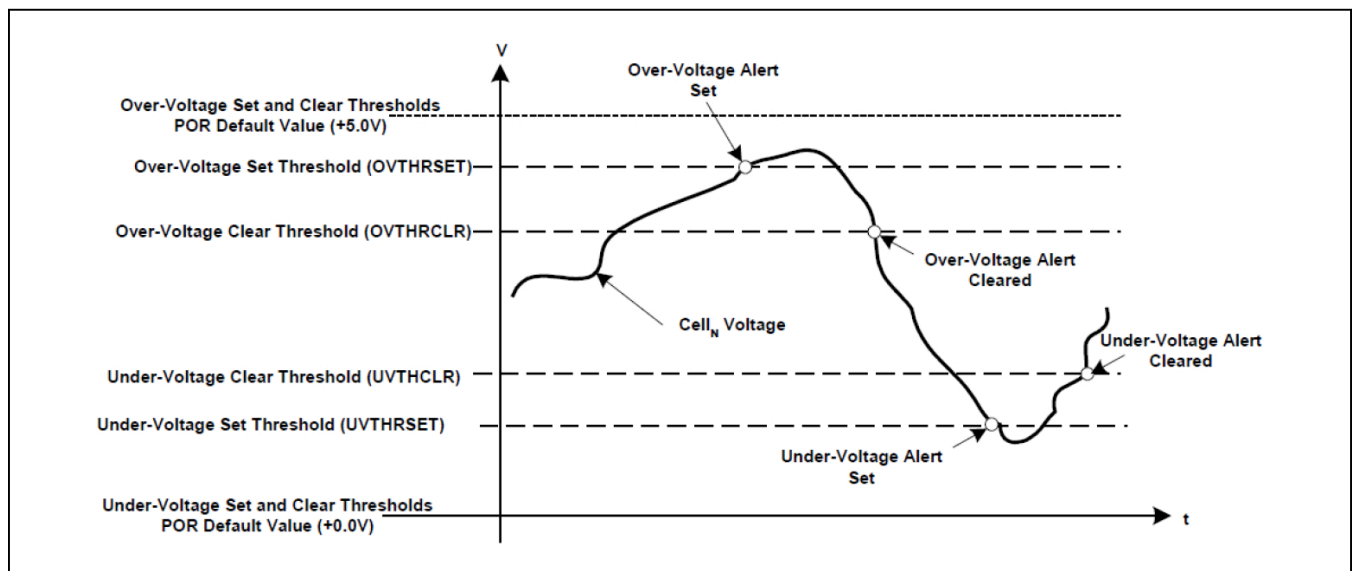

Figure 14. Programmable Overvoltage and Undervoltage Thresholds Diagram

- 8) Write these values in the appropriate registers using the **Write All** button in the **Read/Write Device** tab.
- 9) Select the registers and confirm that values are written appropriately by refreshing a **Single Scan** and then reading the register content.
- 10) Ensure all Overvoltage Alert Enables and Undervoltage Alert Enables are configured properly.
- 11) Select the ALRTOVEN and ALRTUVEN registers and confirm the registers are updated appropriately after a **Scan** refresh.
- 12) Steadily increase the supply voltage up to approximately 52V so that each cell reads greater than 4.2V.
- 13) Refresh the new readings on the **Voltage Measurements** tab.
- 14) Refresh the **Scan**.
- 15) The ALRTOV bit in the STATUS register should be set to '1'. Also, all the ALRTOV [12:1] in the ALRTOVCELL register should be set to '1' and bits ALRTCELL [12:1] in ALRTCELL register should be set to '1'.
- 16) In the MAX17843 Evaluation Kit Software GUI, at the top OV flag also sets to 1 under the **OV** field (Figure 15).
- 17) Now, steadily decrease the supply voltage to 42V (3.5V/cell).
- 18) Repeat steps 13 and 14.
- 19) The ALRTOV bit in the STATUS register should be cleared to '0'. Also, all the ALRTOV [12:1] in the ALRTOVCELL register should be set to cleared and bits ALRTCELL [12:1] in ALRTCELL register should be set to cleared to '0'.
- 20) In the MAX17843 Evaluation Kit Software GUI, at the top OV flag also gets cleared to 0 under the **OV** field (Figure 16).
- 21) Decrease the supply voltage steadily down to 24V so that each cell reads less than 2.4V.
- 22) Refresh the new readings on the **Voltage Measurements** tab.
- 23) Refresh the **Scan**.
- 24) The ALRTUV bit in the STATUS register should be set to '1'.
- 25) Also, all the ALRTUV [12:1] in the ALRTUVCELL register should be set to '1' and bits ALRTCELL [12:1] in ALRTCELL register should be set to '1'.
- 26) In the MAX17843 Evaluation Kit Software GUI, at the top UV flag also gets set to 1 under the **UV** field.
- 27) Steadily increase the supply voltage to 36V (3.0V/cell).
- 28) Repeat steps 22 and 23.
- 29) The ALRTUV bit in the STATUS register should be cleared to '0'. Also, all the ALRTUV [12:1] in the ALRTUVCELL register should be set to cleared and bits ALRTCELL [12:1] in ALRTCELL register should be cleared to '0'.
- 30) In the MAX17843 Evaluation Kit Software GUI, at the top UV flag also should be cleared to "0" under the **UV** field.

This verifies the **OV/UV Set** and **Clear** thresholds for MAX17843. The OV or UV alert can be selected for any specific cell the user wants to monitor the voltage.

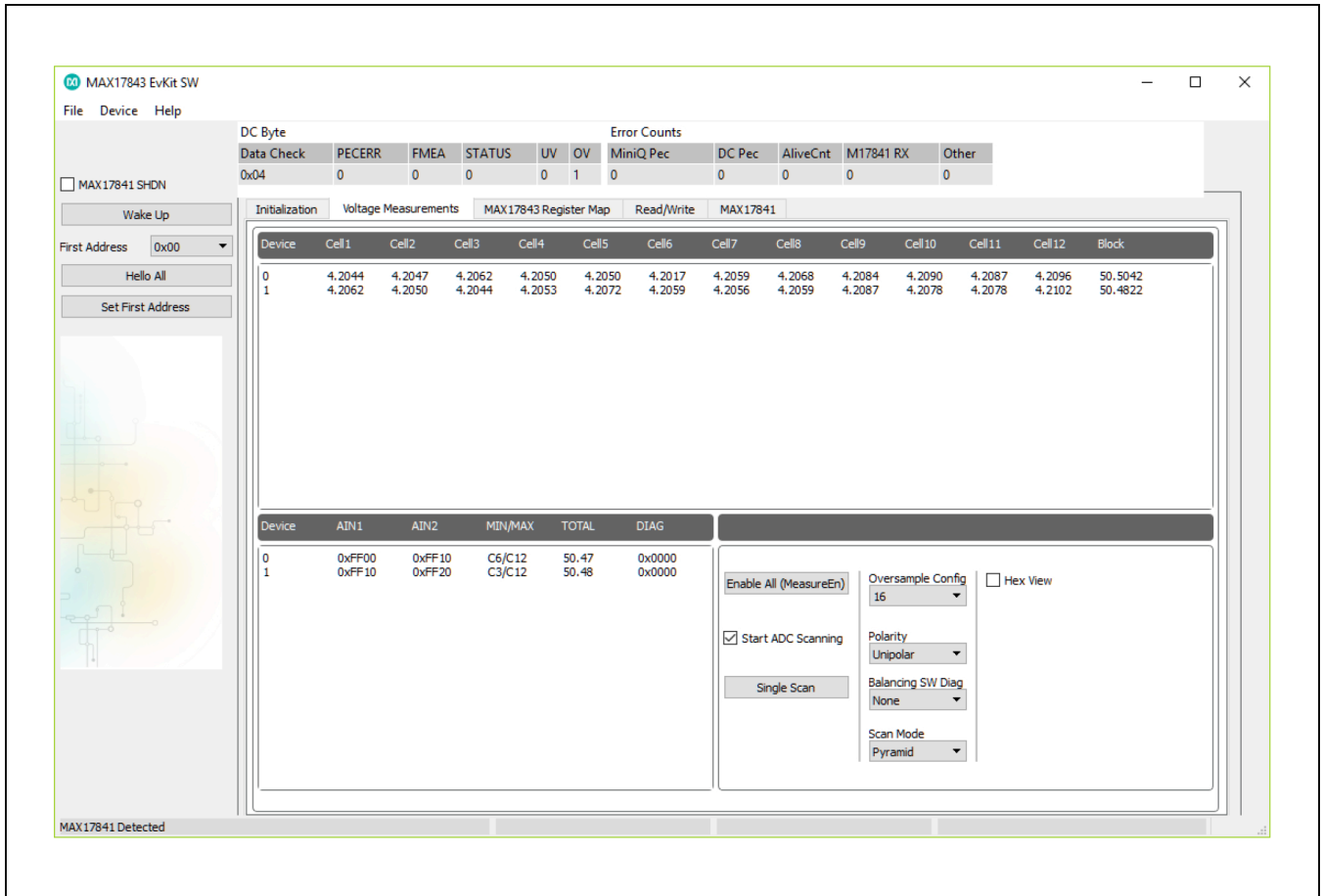

Figure 15. MAX17843 Evaluation Kit Software (Voltage Measurements Tab—OV Flag)

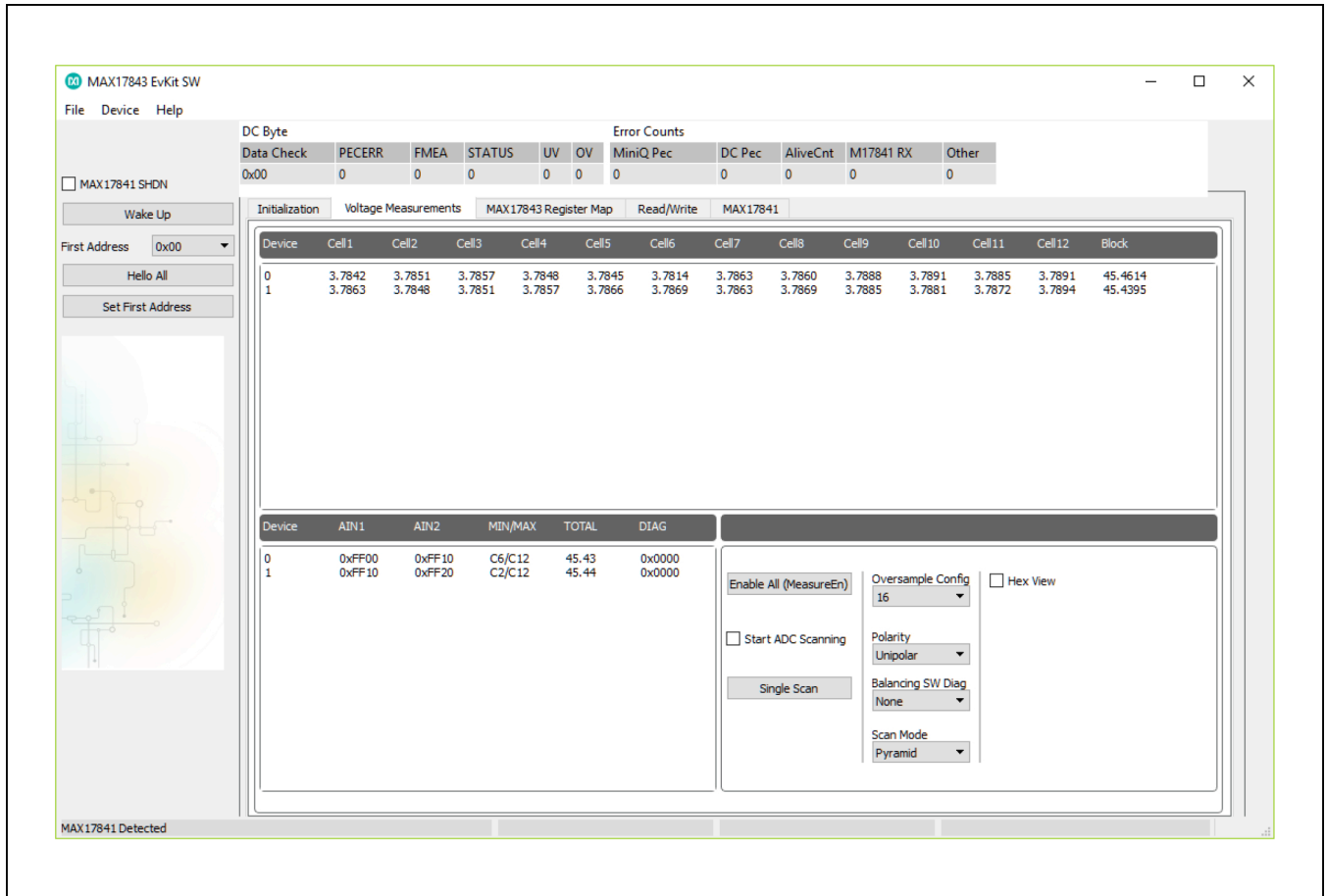

Figure 16. MAX17843 Evaluation Kit Software (Voltage Measurements Tab—OV Flag Cleared)

**B) Cell-Balancing Testing**

With the ASIC communicating normally to the host in a single ASIC configuration, cell balancing, along with the Watchdog Timer configuration is tested. The detailed procedure follows:

12 Li-Ion cells were connected to the MAX17843 device. Module voltage was 45.55V.

**Test Procedure:**

- 1) ASIC ready to measure (cell measurement channels enabled, device addresses configured)
- 2) Confirm cell voltages are as expected by clicking **Single Scan**.
- 3) Enable and configure the Odd-balancing switches from the **BALSWEN**.
- 4) Confirm the BALSWEN register reads 0x0555 by reading the register value (all the odd cell-balancing switches will be turned on).
- 5) Go to the **Voltage Measurements** tab and read the voltages.
- 6) All the odd cell voltages will show a drop in the voltages by a few (this drop depends on battery impedance and the parasitic I\*R drop in the path of that measurement).
- 7) Enable and configure the even balancing switches from the **BALSWEN**.
- 8) Confirm the BALSWEN register reads 0x0AAA by reading the register value (all the even cell-balancing switches will be turned on).
- 9) Go to the **Voltage Measurements** tab and read the voltages.
- 10) All the even-cell voltages will show a drop in the voltages (this drop depends on battery impedance and the parasitic I\*R drop in the path of that measurement).

**C) Die Temperature Diagnostic Testing**

With the ASIC communicating normally to the host in a single ASIC configuration, die temperature diagnostic test was carried out. The procedure regarding the same is listed as follows:

12 Li-Ion cells were connected to MAX17843 device. Module voltage is 45.55V.

**Test Procedure:**

- 1) ASIC ready to measure (cell-measurement channels enabled, device addresses configured).
- 2) Confirm cell voltages are as expected in the **Voltage Measurements** tab.
- 3) In the **Read/Write** tab, configure the DIAGSEL [2:0] bits in the DIAGCFG register (0x51) to select the die temperature. This is done by doing a WRITEALL of the value 0x0006 into the DIAGCFG register (0x51).
- 4) Select the **Die temperature** option (0b110) from the register and configure the device.
- 5) The user will see the result by reading the DIAG register (0x50).
- 6) In this case, since the part was tested at room temperature, the DIAG showed a value of 21.86°C when converted from the DIAG register results.
- 7) Refer to the *Die Temperature Measurement* section in the MAX17843 IC data sheet for die temperature conversions from results of DIAG register into °C.

**Ordering Information**

PART	TYPE
MAX17843EVKIT#	EV Kit

#Denotes RoHS compliant.



MAX17843 EV Kit Bill of Materials

QTY	REFERENCE DESIGNATOR	DESCRIPTION	PART NO.	Y = Lead-free & RoHS Compliant R = RoHS Compliant Only N = Non-Compliant	COMPONENT (* = Sampled)
6	AGND (x6)	Multipurpose Test Points, Black	EH0400		
1	C1, C57, C58, C63	2200pF ±5%, 630V COG ceramic capacitors, auto grade (1206)	EC2493		
3	C2, C84, C102	0.47µF ±10%, 16V X7R ceramic capacitors (0603)	ECM0581	Y	*
1	C3	1µF ±10%, 16V X7R ceramic capacitors (0603)	ECM0602	Y	*
1	C5	2.2µF ±10%, 100V X7R ceramic capacitors (1210)	ECM0711	Y	*
13	C6-C17, C25	0.1µF ±10%, 100V X7R ceramic capacitors, automotive grade (0605)	ECM0826	Y	*
1	C18	100pF ±5%, 50V COG ceramic capacitors (0402)	ECM0122	Y	*
1	C21	1000pF ±10%, 25V X7R ceramic capacitors, automotive grade (0603)	ECM0912	Y	*
1	C23	4.7µF ±10%, 50V X7R ceramic capacitors (1210)	ECM0643		
1	C24	0.1µF ±10%, 100V X7R ceramic capacitors, automotive grade (0603)	ECM0864	Y	*
1	C27	0.47µF ±10%, 100V X7S ceramic capacitors, automotive grade (0805)	ECM0581		
1	C40	1µF ±10%, 100V X7R ceramic capacitors (1206)	ECM0799		
24	C41-C52, C67-C78	0.1µF ±10%, 100V X7R ceramic capacitors, automotive grade (0805)	ECM0826	Y	*
4	C53, C54, C79, C81	15pF ±5%, 100V COG ceramic capacitors, automotive grade (0603)	ECM0896	Y	*
2	C55, C56	0.01µF ±5%, 50V COG ceramic capacitors (0603)			
3	C1001, C1002, C1003	0.1µF ±10%, 50V X7R ceramic capacitors (0603)	ECM0445		
4	D1, D2, D7, D11	ESD protection diodes (SOT-23)	ED0781		
4	D9, D10, D12, D13	1A, 150V diodes POWERD®123	ED0884	Y	
2	D14, D27	Unidirectional ESD protection diodes (SOD323)	ED0782		
2	D28, D29	Dual Switching Common Cathode Diode	ED0885	Y	
	DCIN, THRM, VDDL1, VDDL1, VDDL3, VDDL4, VAA, VAA, GPIO3_A, GPIO2_A, GPIO1_A, GPIO0_A, HV, TXUP, TXUN, RXUP, RXUN, TXLP, TXLN, RXLP, RXLN, TXLP_A, TXLN_A, RXLP_A, RXLN_A, /SHDN1				
30		Multipurpose Test Points, Red	EH0384	Y	
1	J5	26 pin dual row (2x13) headers (0.1in centers)	EH0205	Y	
21	JU0, JU1, JU2, JU3, JU14, JU15, JU16, JU17, JU18, JU19 CELL2, CELL3, CELL4, CELL5, CELL6, CELL7, CELL8, CELL9, CELL10, CELL11, CELL12	2 pin headers (0.1in centers)	EH0072	Y	
16	PACK+, PACK-, BAT0-BAT12, AGND	20G tinned copper Bus wire formed into "U" stepped loops (0.25" off the PC board)	EBUSS20W	Y	
1	P1	15-circuit CLK-Mate Vertical PCB Receptacle, 1.50mm pitch	EH1172		
6	P2, P3, P5, P6, P8, P9	2-circuit CLK-Mate Vertical PCB Receptacle, 1.50mm pitch	EH1174		
1	R1	100Ω ±5% resistors (1206)	ER0512061000		
1	R2	1kΩ ±5% resistors (0603)	ER0506031001		

MAX17843 EV Kit Bill of Materials (continued)

QTY	REFERENCE DESIGNATOR	DESCRIPTION	PART NO.	Y = Lead-free & RoHS Compliant R = RoHS Compliant Only N = Non-Compliant	COMPONENT (* = Sampled)
13	R3-R15	1kΩ ±1%, resistors (0603)	ER0106031001		
2	R80,R87	1kΩ ±1%, resistors (0603)	ER0106031001		
13	R16-R27, R30	120, 1W resistors (2512)	ER1073		
12	R28, R29, R56, R67, R60, R61, R64, R65, R75, R76	10kΩ ±1%, resistors (0603)	ER0106031002		
4	R32, R33, R34, R35	150kΩ ±5% resistors (0402)	ER0504021503		
10	R36, R37, R38, R39, R79, R85, R105, R106, R111, R1016	0Ω resistors (0603)	ER0506030R00		
4	R40, R62, R63, R66	100kΩ ±5%, resistors (0603)	ER0506031003		
12	R42-R53	2.0kΩ ±0.1% resistors (0605)	ER0998		
4	R31, R41, R58, R59	100Ω ±1% resistors (1206)	ER0112061000		
8	R54, R55, R77, R78, R67, R68, R70, R72	26.1kΩ ±1% resistors (1206)	ER01120626R1		
8	R69, R71, R83, R84, R85, R86, R93, R94	0Ω resistors (1206)	ER0512060R00		
4	R73, R74, R81, R82	1.5kΩ ±1% resistors (1206)	ER0112061501		
1	R110	10.0kΩ ±1% resistor (0805)	ER01080510R0		
1	SW1	12 position SPST DIP switches	EH0834	Y	
1	U1	Daisy-Chainable Analog Front End (64L LOFP)	MAX17843BGGCB/V+	Y	*
2	U2, U3	FMB3906A Dual PNP SSOT-6	EQ1344		
21	-	Shunts	EH0071	Y	
1	-	PCB: MAX17843EVKIT	MAX17843EVKIT#		
<b>NOT INSTALLED COMPONENTS</b>					
0	C4	Not installed, ceramic capacitors (2220)			
0	C19, C20	Not installed, 0.01µF ±5%, 50V C0G ceramic capacitors (0603)			
0	C22	Not installed, ceramic capacitor (1210)			
0	C26	Not installed, 2.2µF ±10%, 100V X7R ceramic capacitors (1210)			
0	C28-C39, C65, C66, C85, C100, C101, C103, C86, C87, C90, C91	Not installed, ceramic capacitors (0603)			
0	C61, C62, C92, C93	Not installed, ceramic capacitor (0805)			
0	C94, C95, C80, C82	Not installed, 3 terminal capacitor (0805)			
0	D3, D4, D5, D6	Not installed, zener diodes (SOD123)			
0	D8	Not installed, 500mW, 4.3V Zener Diode		Y	
0	D15-D26	Not installed, Unidirectional ESD protection diodes (SOD323)			
0	D30, D31, D32, D33	Not installed, 100V, 1A Schottky diode (SOD123-FL)			
0	D34	1A, 150V diodes POWERD@123		Y	
0	D38	Not installed 1A, 100V diodes (SMA)		Y	*
0	J1, J2, J3, J4	Not installed, 16 pin receptacles (0.1in centers)			
0	J6	Not installed, 14-pin dual row shrouded (7x2) header (0.1 in centers)			
0	L3, L4	Not installed, Automotive common mode filter			
0	R97, R101	Not installed, 0Ω resistors (1206)			
0	R98, R99, R108, R109, R1014, R1015, R112	Not installed, resistors (0603)	ER0612060R00		



MAX17843 EV Kit Schematic (continued)

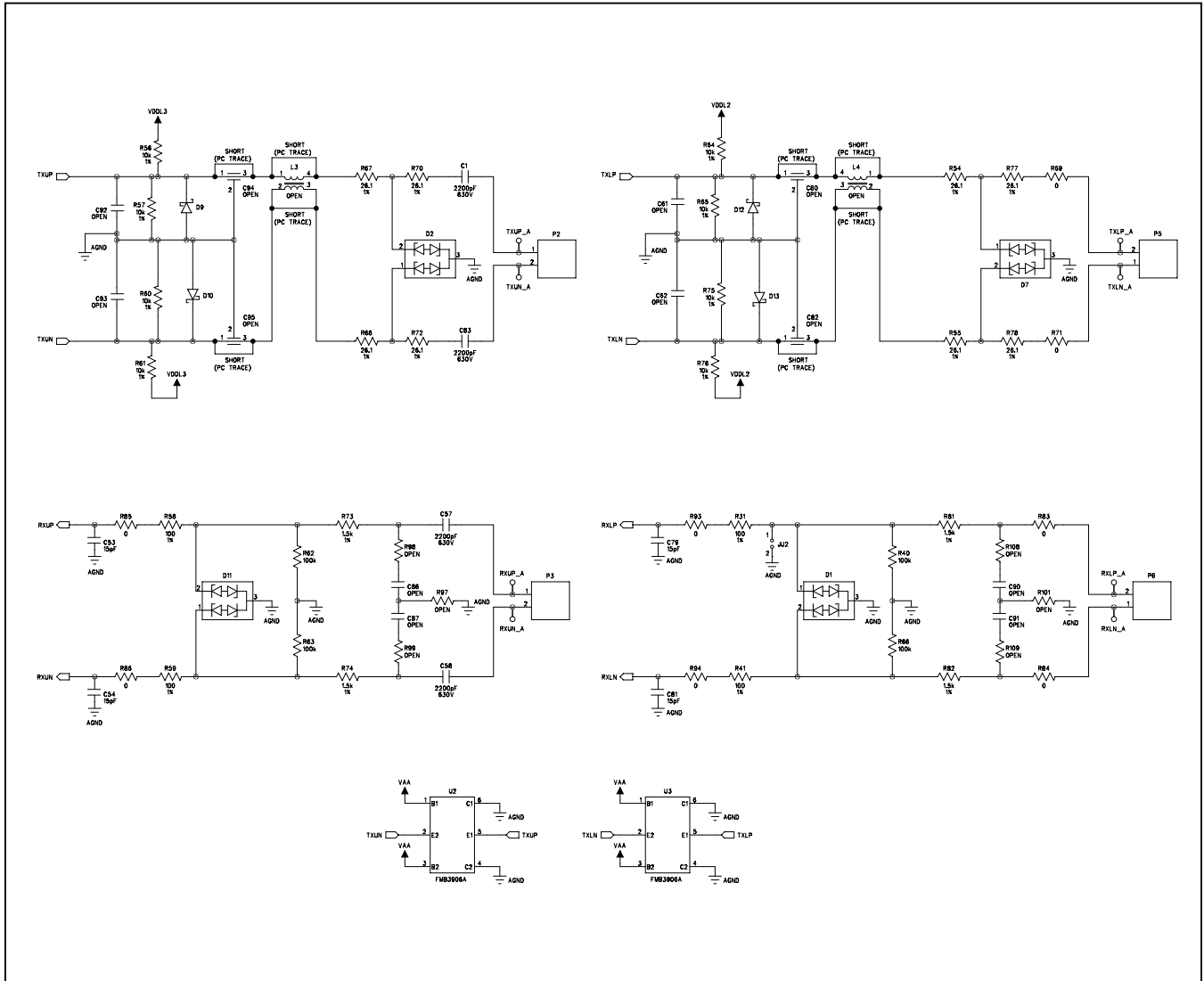



MAX17843 EV Kit Schematic (continued)

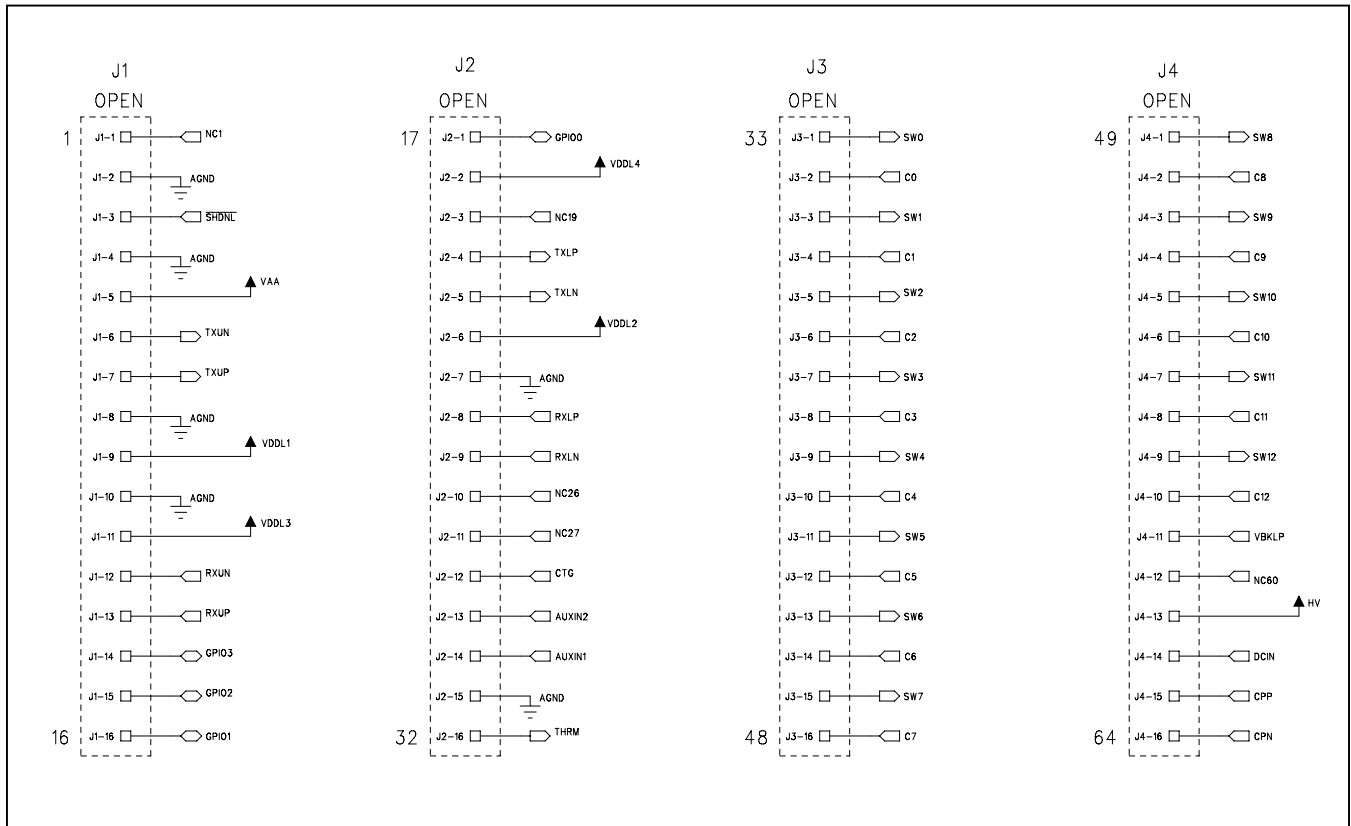

MAX17843 EV PCB Layouts

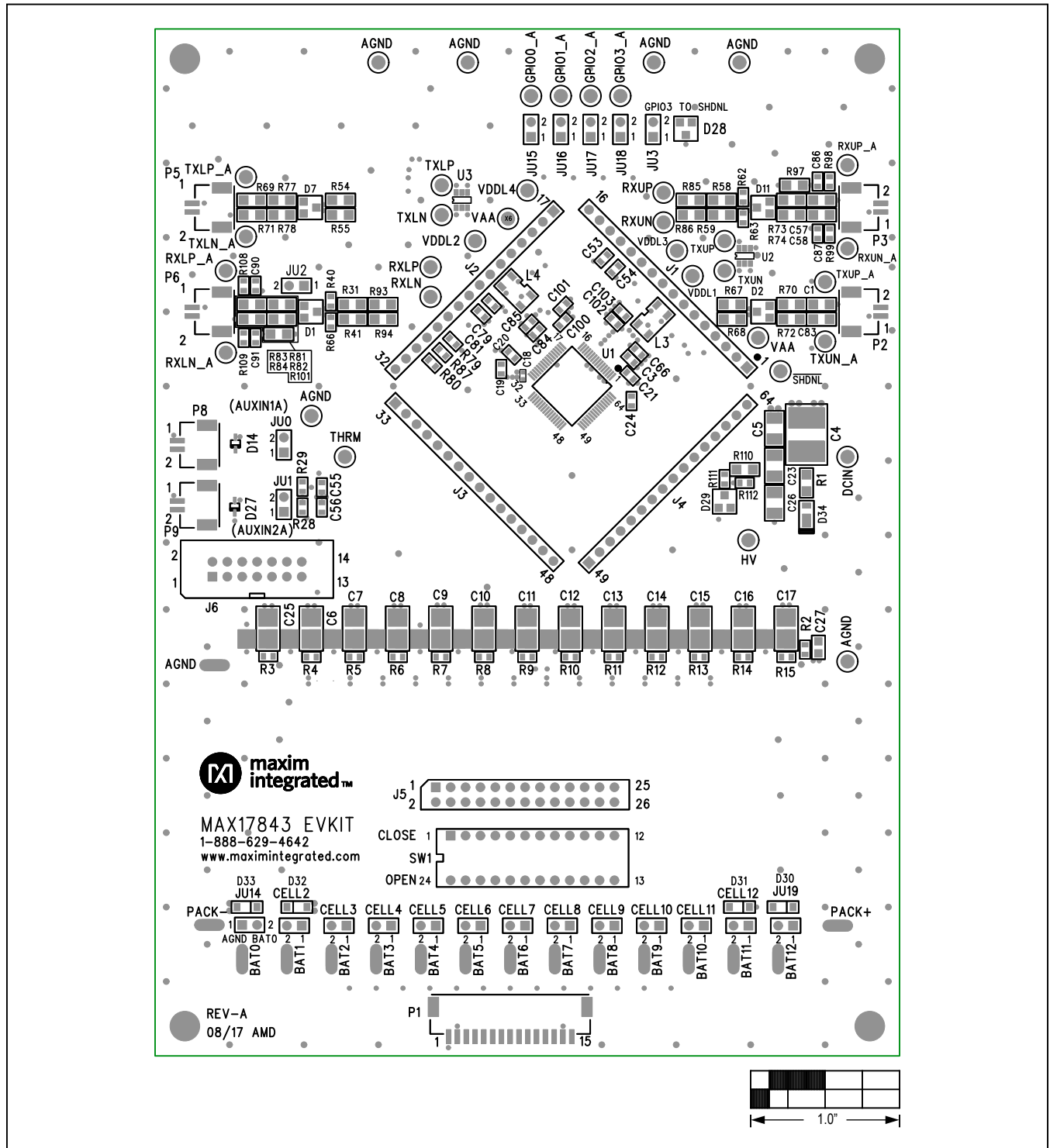

MAX17843 EV Kit Component Placement Guide—Top Silkscreen

MAX17843 EV PCB Layouts (continued)

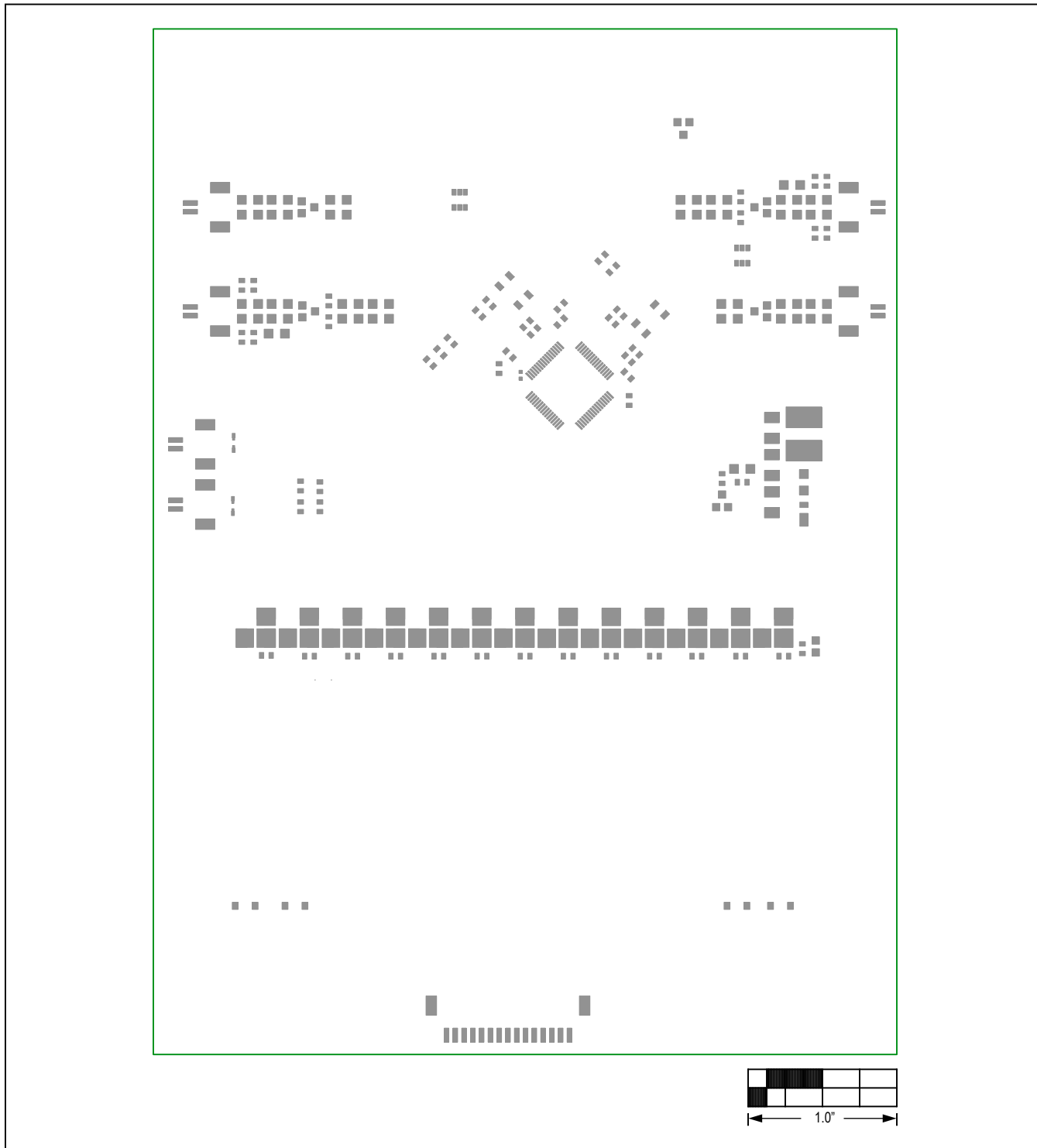

MAX17843 EV Kit PCB Layout—Top Pastemask



MAX17843 EV PCB Layouts (continued)

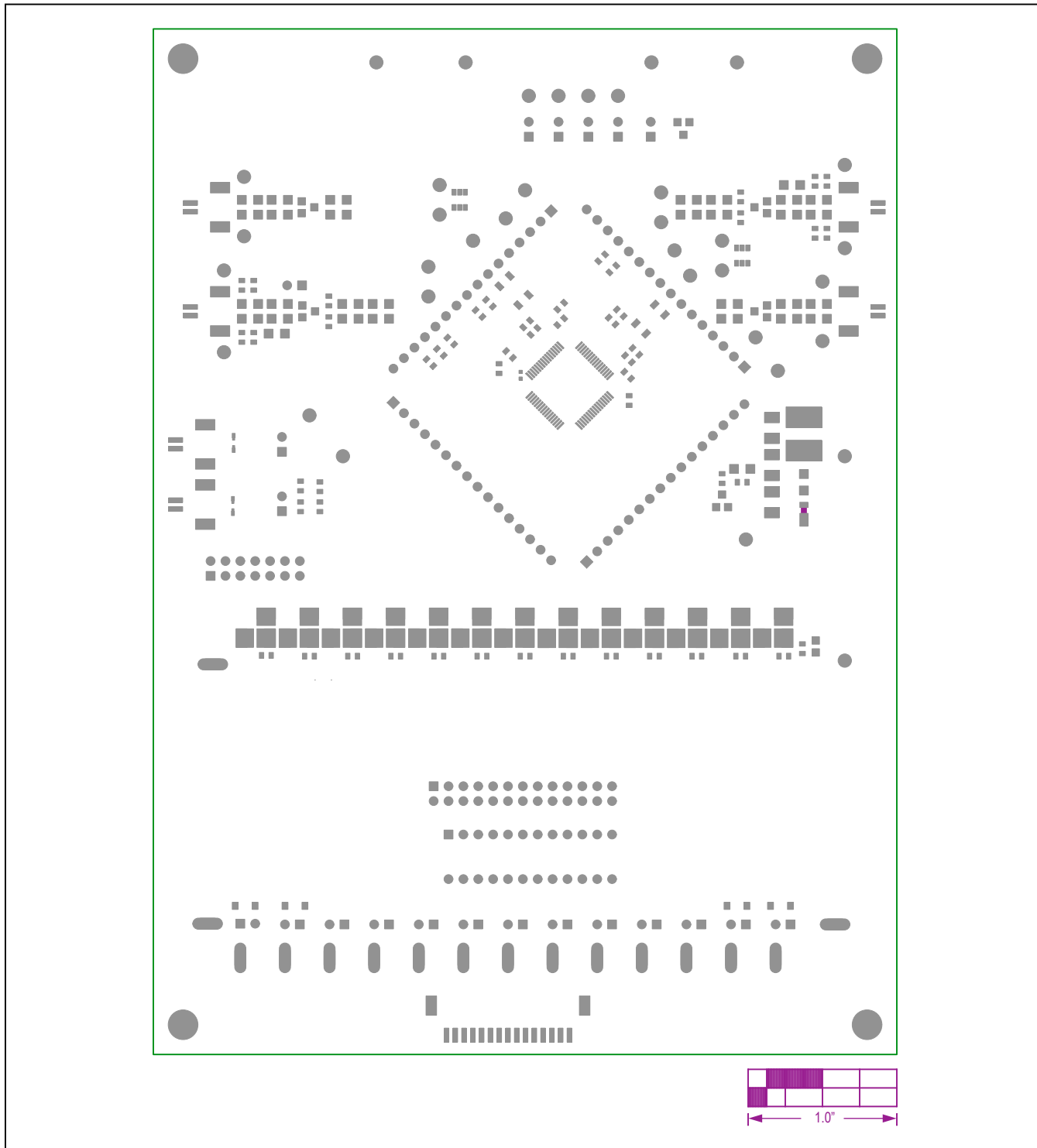

MAX17843 EV Kit PCB Layout—Top Soldermask

MAX17843 EV PCB Layouts (continued)

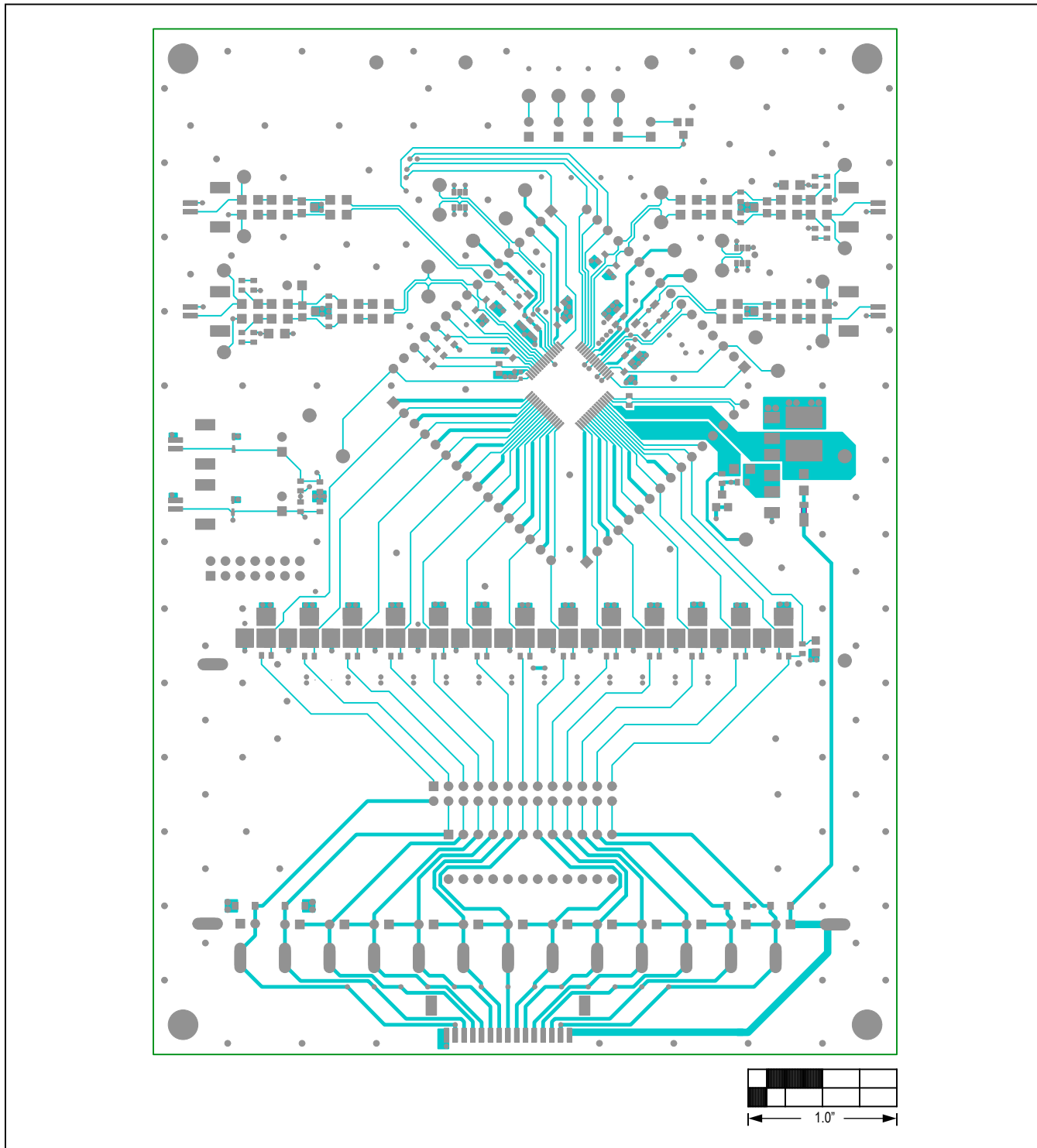

MAX17843 EV Kit PCB Layout—Component Side

MAX17843 EV PCB Layouts (continued)

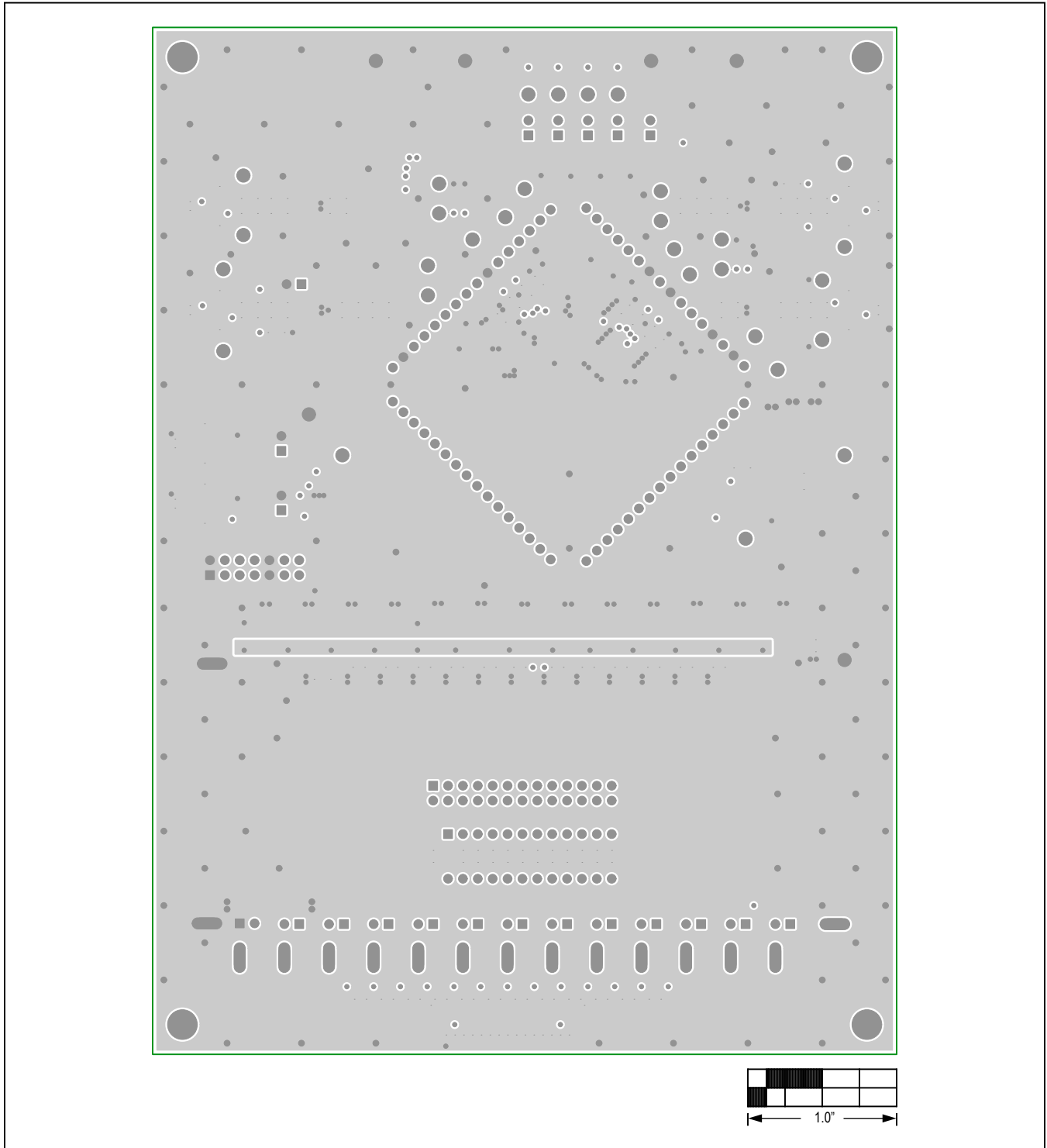

MAX17843 EV Kit PCB Layout—Layer 2 (GND)



MAX17843 EV PCB Layouts (continued)

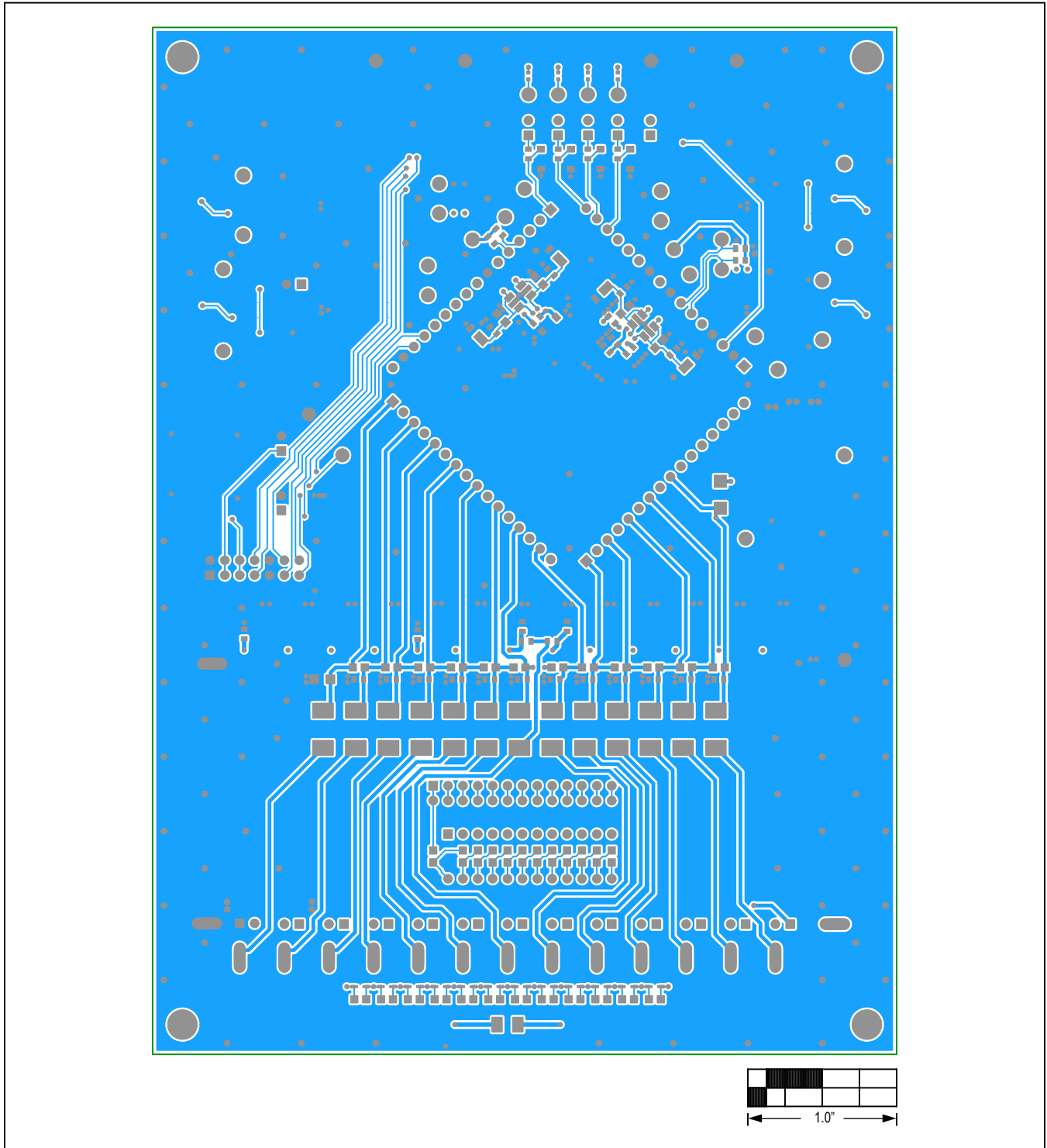

MAX17843 EV Kit PCB Layout—Solder Side

MAX17843 EV PCB Layouts (continued)

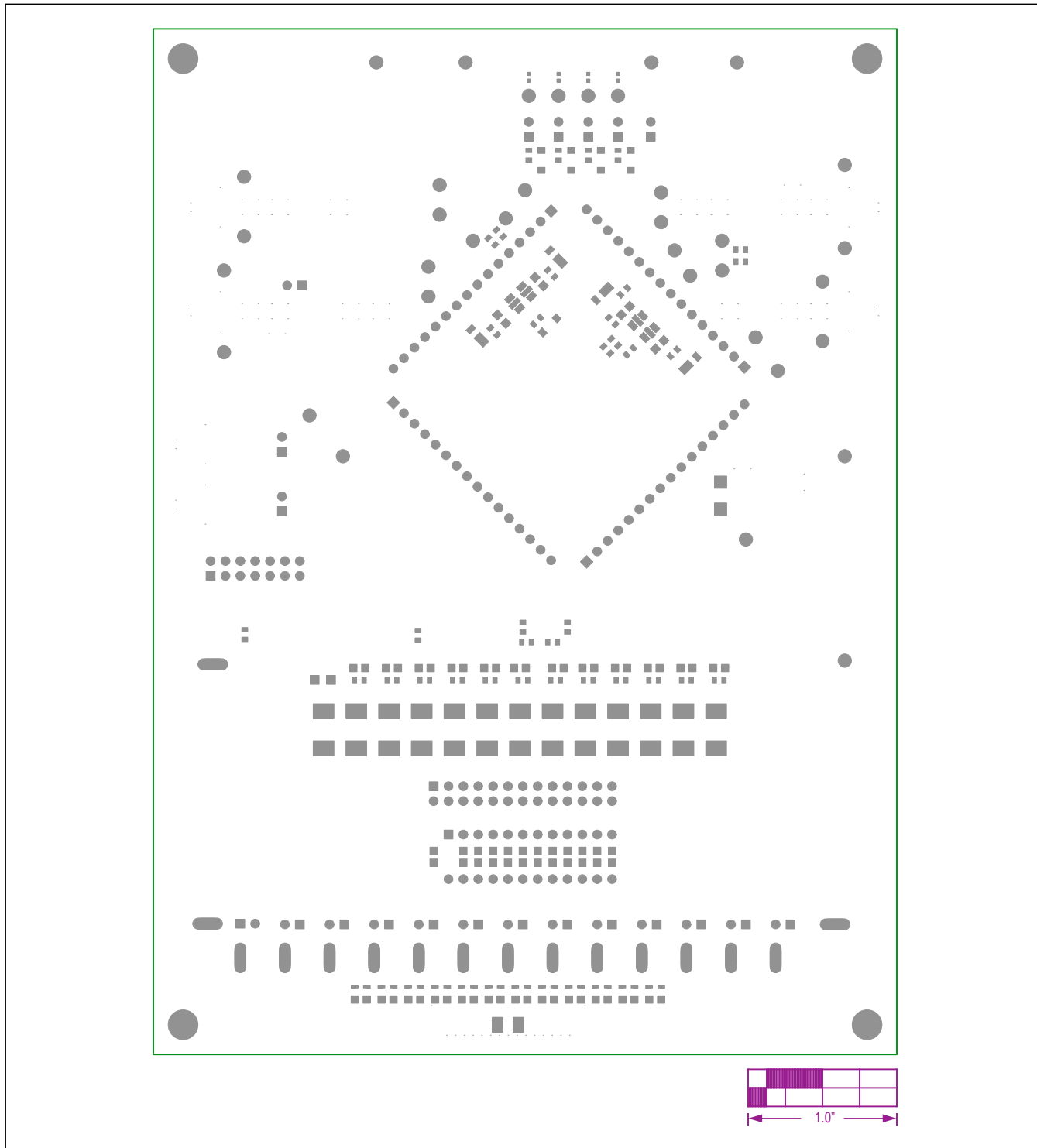

MAX17843 EV Kit PCB Layout—Bottom Soldermask

MAX17843 EV PCB Layouts (continued)

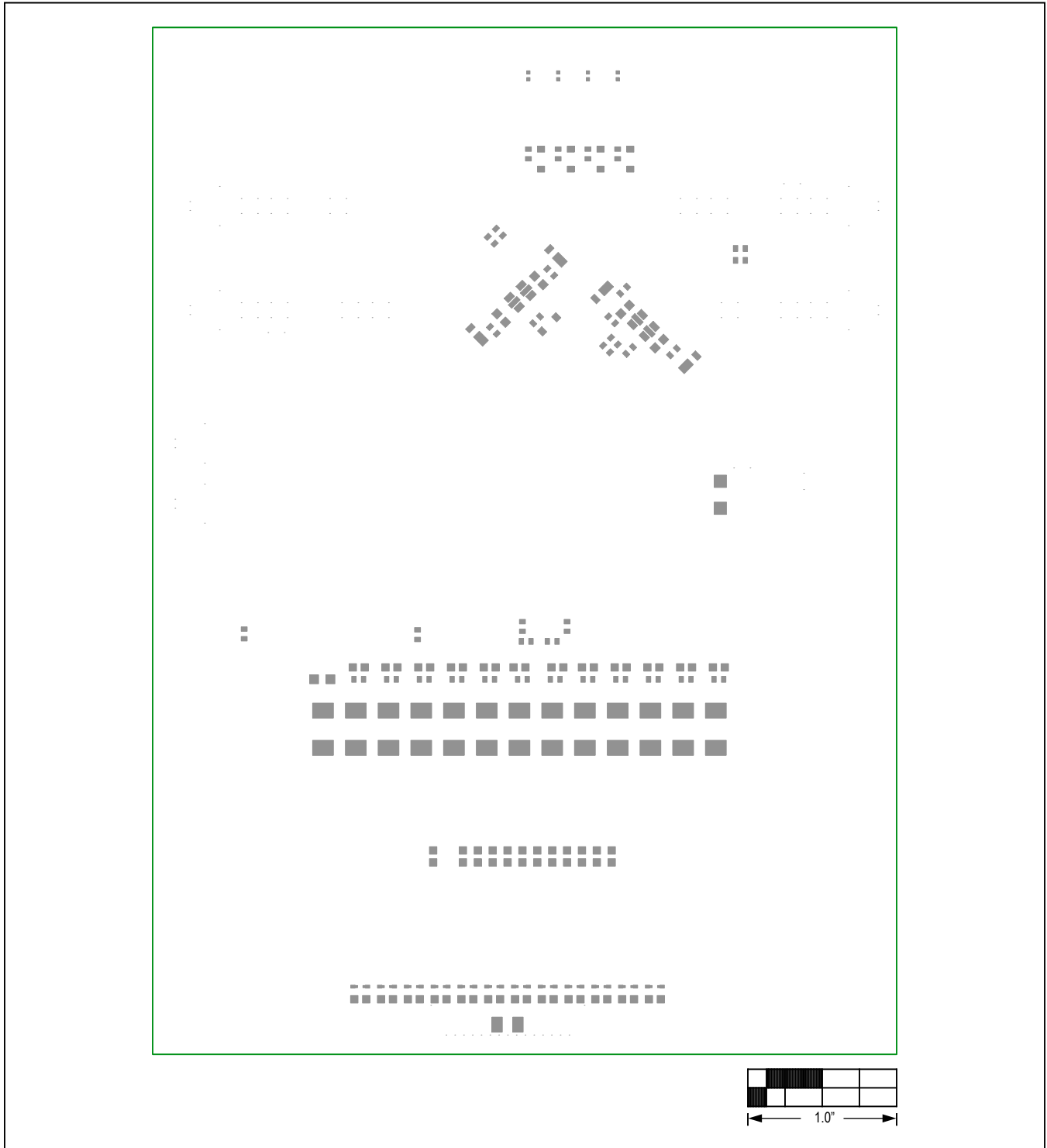

MAX17843 EV Kit PCB Layout—Bottom Pastemask

MAX17843 EV PCB Layouts (continued)

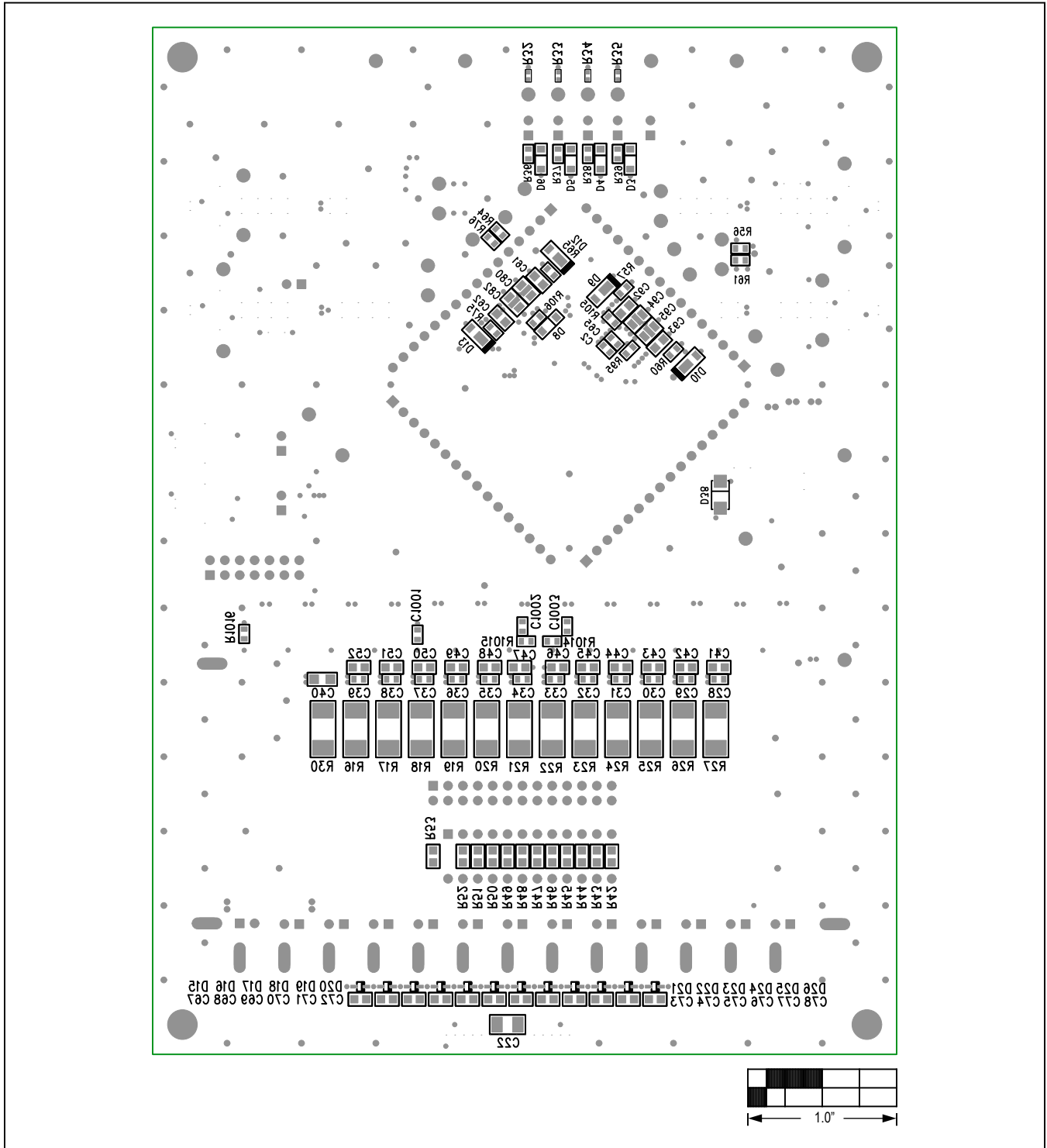

MAX17843 EV Kit Component Placement Guide—Bottom Silkscreen



### Revision History

REVISION NUMBER	REVISION DATE	DESCRIPTION	PAGES CHANGED
0	12/17	Initial release	—

For pricing, delivery, and ordering information, please contact Maxim Direct at 1-888-629-4642, or visit Maxim Integrated's website at [www.maximintegrated.com](http://www.maximintegrated.com).

*Maxim Integrated cannot assume responsibility for use of any circuitry other than circuitry entirely embodied in a Maxim Integrated product. No circuit patent licenses are implied. Maxim Integrated reserves the right to change the circuitry and specifications without notice at any time.*