

Metal Film Precision Resistors

CSR Series

multicomp PRO

**RoHS
Compliant**



Features

- Excellent overall stability
- Tight tolerance down to $\pm 0.1\%$
- Extremely low TCR down to ± 10 PPM/ $^{\circ}\text{C}$
- High power rating up to 1 Watts

Applications

- Automotive
- Telecommunication
- Medical Equipment
- Measurement / Testing Equipment

Construction

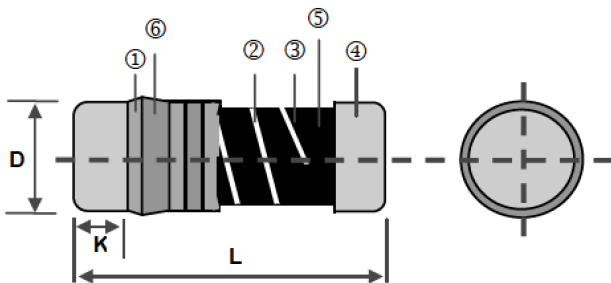

①	Insulation Coating	④	Electrode Cap (Fe, Cu, Sn)
②	Trimming Line	⑤	Resistor Layer
③	Ceramic Road	⑥	Marking

Dimensions

Type	Case Style	L	ΦD	K min.	Weight (g) (1,000pcs)	Packaging
						180mm (7")
MCFRBTNV MCFRFTDV	1405 [3614 Metric]	3.50 ± 0.2	1.40 ± 0.15	0.5	18.7	3,000EA
MCFRFTDU	2409 [6123 Metric]	5.90 ± 0.2	2.20 ± 0.20	0.5	80.9	2,000EA

Dimensions : Millimetres

Derating Curve

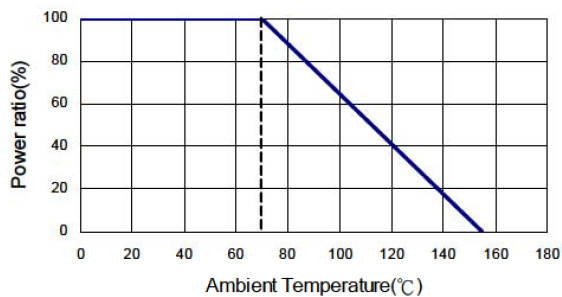

Metal Film Precision Resistors

CSR Series



Standard Electrical Specifications

Item Type	Power Rating at 70°C	Operating Temp. Range	Max. Operating Voltage	Max. Overload Voltage	Resistance Range					TCR (PPM/°C)
					± 0.1%	± 0.25%	± 0.5%	± 1%	± 5%	
MCFRBTN MCFRFTDV	1 / 4W	-55 ~ +155°C	200V	400V	49.9Ω - 20KΩ					± 10
					49.9Ω - 300KΩ					± 15
					10Ω - 1MΩ			10Ω - 4.7MΩ		± 25
					10Ω - 1MΩ	1Ω - 1MΩ	0.2Ω - 10MΩ		± 50	
					-			0.1Ω - 10MΩ		± 100
	Jumper: 2A					0Ω (<15mΩ)		-		
MCFRFTDU	1 / 2W	-55 ~ +155°C	300V	500V	49.9Ω - 20KΩ					± 10
					49.9Ω - 300KΩ					± 15
					10Ω - 1MΩ			10Ω - 4.7MΩ		± 25
					10Ω - 1MΩ	1Ω - 1MΩ	0.2Ω - 10MΩ		± 50	
					-			0.1Ω - 10MΩ		± 100
	Jumper: 4A					0Ω (<15mΩ)		-		

High Power Rating Electrical Specifications

Item Type	Power Rating at 70°C	Operating Temp. Range	Max. Operating Voltage	Max. Overload Voltage	Resistance Range					TCR (PPM/°C)
					± 0.1%	± 0.25%	± 0.5%	± 1%	± 5%	
MCFRFTDU	1W	-55 ~ +155°C	350V	700V	49.9Ω - 100KΩ					± 15
					10Ω - 1MΩ					± 25
					10Ω - 1MΩ	1Ω - 1MΩ	0.2Ω - 10MΩ		± 50	
					-			0.1Ω - 10MΩ		± 100

Metal Film Precision Resistors

CSR Series

multicomp PRO

Environmental Characteristics

Item	Requirement	Test Method
Temperature Coefficient of Resistance (T.C.R.)	As Spec	JIS-C-5201-1 4.8 IEC 60115-1 4.8 -55°C ~ +125°C, 25°C is the reference temperature
Short Time Overload	± (0.15% + 0.05Ω)	JIS-C-5201-1 4.13 IEC-60115-1 4.13 RCWV × 2.5 or Max. overload voltage for 5 seconds
Insulation Resistance	≥ 10G	JIS-C-5201-1 4.6 IEC-60115-1 4.6 Max.overload voltage for 1minute
Endurance	± (0.5% + 0.05Ω)	JIS-C-5201-1 4.25 IEC-60115-1 4.25.1 70 ± 2°C, Max. working voltage for 1,000 hrs with 1.5 hrs "ON" and 0.5 hrs "OFF"
Damp Heat with Load	± (1.0% + 0.05Ω)	JIS-C-5201-1 4.24 40 ± 2°C, 90 ~ 95% R.H. Max. working voltage for 1,000 hrs with 1.5 hrs "ON" and 0.5 hrs "OFF"
Dry Heat	± (1.0% + 0.05Ω)	JIS-C-5201-1 4.23 IEC-60115-1 2.23.2 at +155°C for 1,000 hrs
Bending Strength	± (0.5% + 0.05Ω)	JIS-C-5201-1 4.33 IEC 60115-1 4.33 Bending once for 5 seconds with 2mm
Solderability	95% min.coverage	JIS-C-5201-1 4.17 IEC 60115-1 4.17 245 ± 5°C for 3 seconds
Resistance to Soldering Heat	± (0.5% + 0.05Ω)	JIS-C-5201-1 4.18 IEC 60115-1 4.18 260 ± 5°C for 10 seconds
Voltage Proof	No breakdown or flash-over	JIS-C-5201-1 4.7 IEC 60115-1 4.7 1.42 times RCWV (RMS) for 1minute
Leaching	Individual leaching area ≤ 5% Total leaching area ≤ 10%	JIS-C-5201-1 4.18 IEC 60068-2-58 8.2.1 260 ± 5°C for 30 seconds
Rapid Change of Temperature	± (0.5% + 0.05Ω)	JIS-C-5201-1 4.18 IEC 60115-1 4.18 -55°C ~ +155°C, 5 cycles

Storage Temperature : 25 ± 3°C; Humidity < 80%RH

Soldering Condition

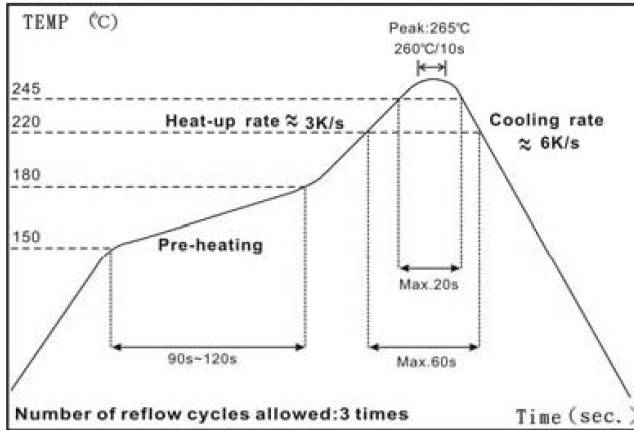

IR Reflow Soldering

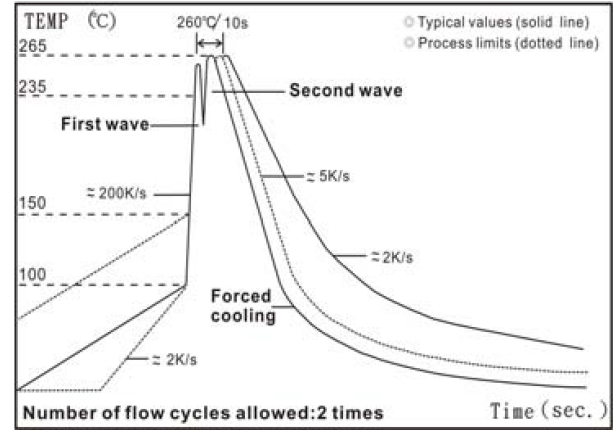

Wave Soldering (Flow Soldering)

- (1) Time of IR reflow soldering at maximum temperature point 260°C : 10s
- (2) Time of wave soldering at maximum temperature point 260°C : 10s
- (3) Time of soldering iron at maximum temperature point 410°C : 5s

Packing

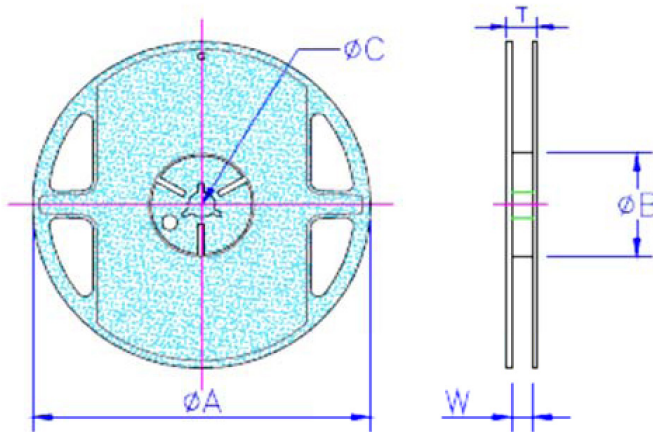

Packing Quantity & Real Specifications

Type	ΦA	ΦB	ΦC	W	T	Emboss Plastic Tape (EA)
MCFRBTN MCFRFTDV	178.5 ± 1.5	60 ± 1	13 ± 0.2	9 ± 0.5	12.5 ± 0.5	3,000
MCFRFTDU	178.5 ± 1.5	60 ± 1	13 ± 0.5	13 ± 0.5	15.5 ± 0.5	2,000

Dimensions: mm

Metal Film Precision Resistors

CSR Series



Emboss Plastic Tape Specifications

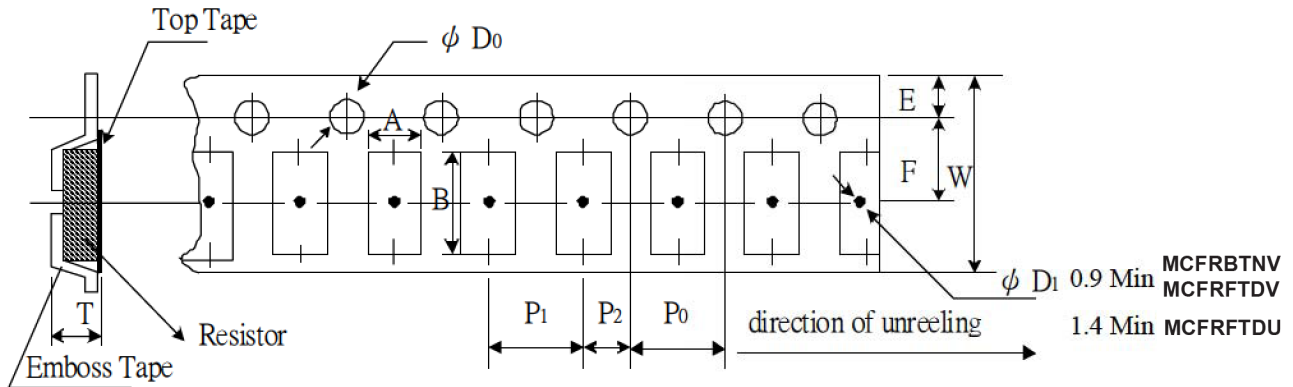

Type	A	8	w	E	F	P ₀	p ₁	p ₂	ΦD ₀	T
MCFRBTNV MCFRFTDV	1.6 ± 0.10	3.7 ± 0.1	8 ± 0.1	1.75 ± 0.1	3.5 ± 0.05	4 ± 0.1	4 ± 0.1	2 ± 0.05	1.5 + 0.1	1.87 ± 0.1
MCFRFTDU	2.4 ± 0.1	6.05 ± 0.1	12 ± 0.1	1.75 ± 0.1	5.5 ± 0.05	4 ± 0.1	4 ± 0.1	2 ± 0.05	1.5 + 0.1	2.8 ± 0.1

Dimensions: mm

Pulse withstanding capacity

The single impulse graph is the result of 50 impulses of rectangular shape applied at one-minute intervals. The limit of acceptance was a shift in resistance of less than 1% from the initial value. The power applied was subject to the restrictions of the maximum permissible impulse voltage graph shown.

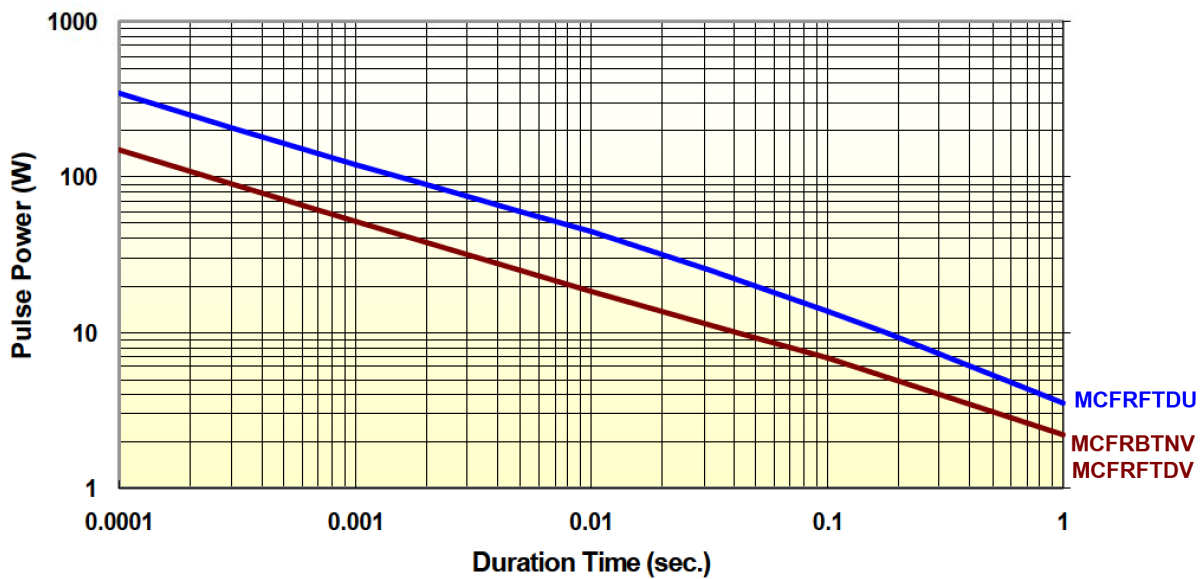

Continuous Pulse

The continuous load graph was obtained by applying repetitive rectangular pulses where the pulse period was adjusted so that the average power dissipated in the resistor was equal to its rated power at 70°C. Again the limit of acceptance was a shift in resistance of less than 1% from the initial value.

CSR Series Continuous Pulse (100Ω)

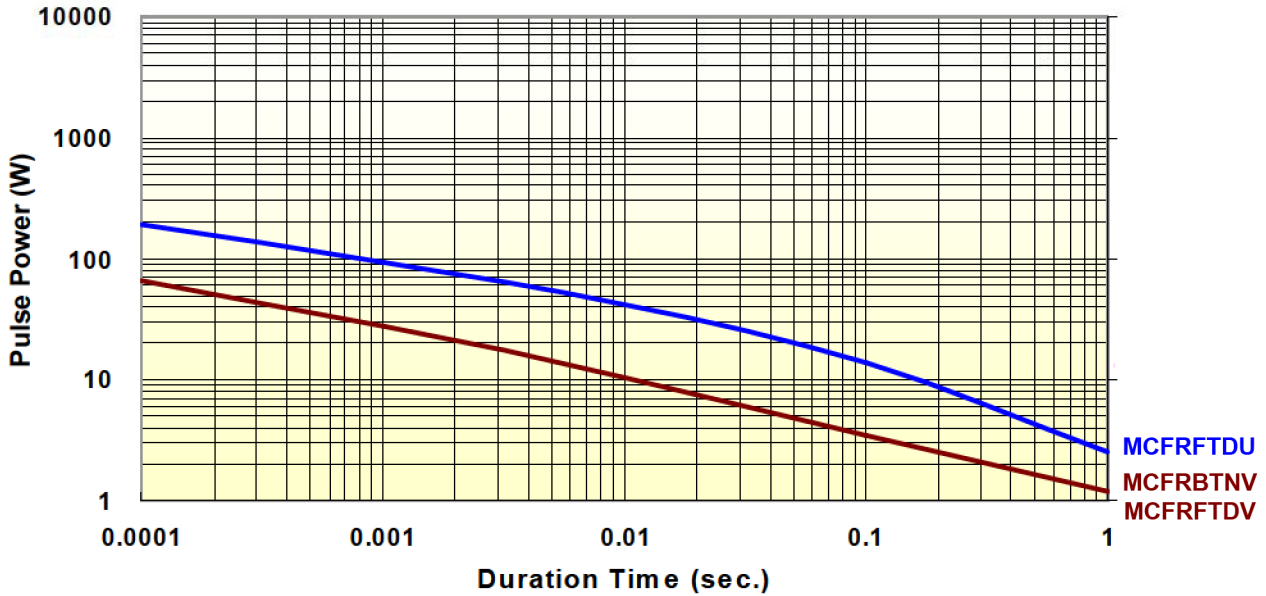

CSR Series Pulse (100Ω)

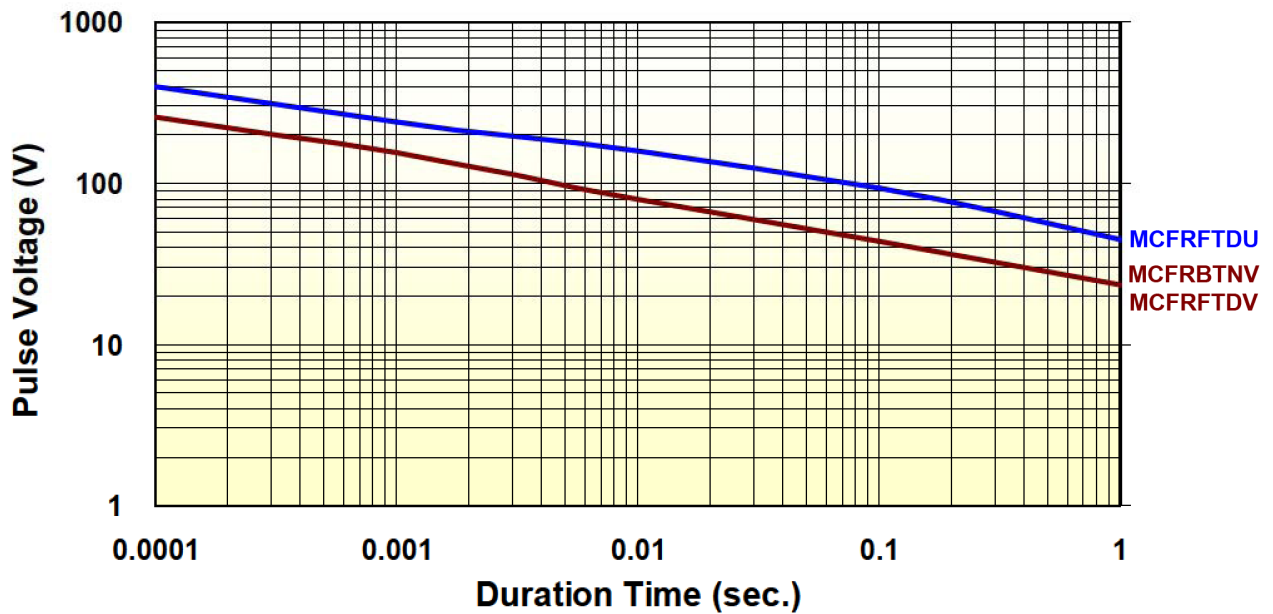

Frequency behavior

Resistors are designed to function according to ohmic laws. This is basically true of resistors for frequencies up to 100KHz. At higher frequencies, there is an additional contribution to the impedance by an ideal resistor switched in series with a coil and both switched parallel to a capacitor. The values of the capacitance and inductance are mainly determined by the dimensions of the terminations and the conductive path length.

The environment surrounding components has a large influence on the behavior of the component on the printed-circuit board.

Frequency vs. Impedance
CSR Series (MCFRBTNV / MCFRFTDV)

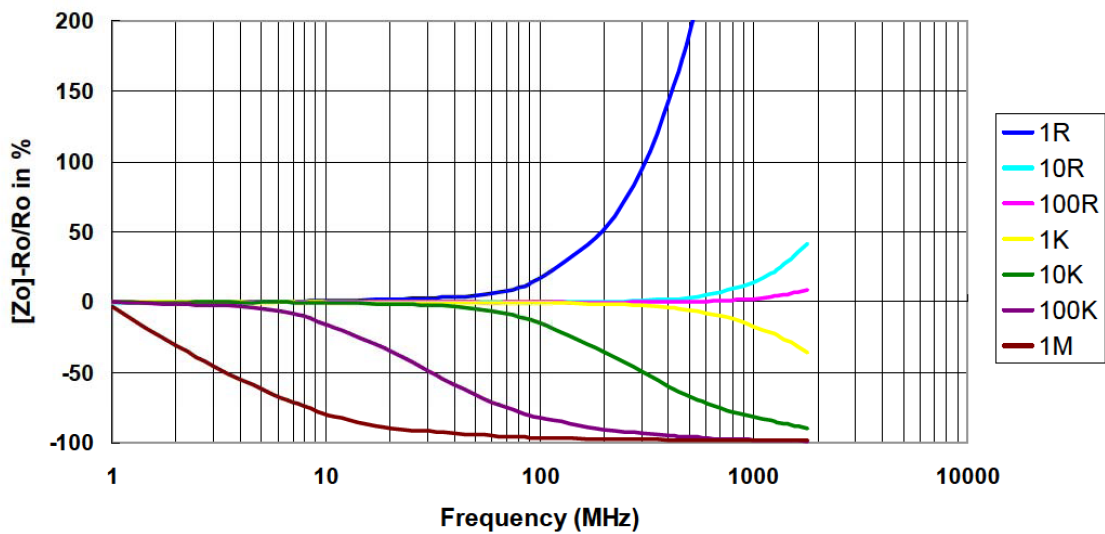

Frequency vs. Phase Angle
CSR Series (MCFRBTNV / MCFRFTDV)

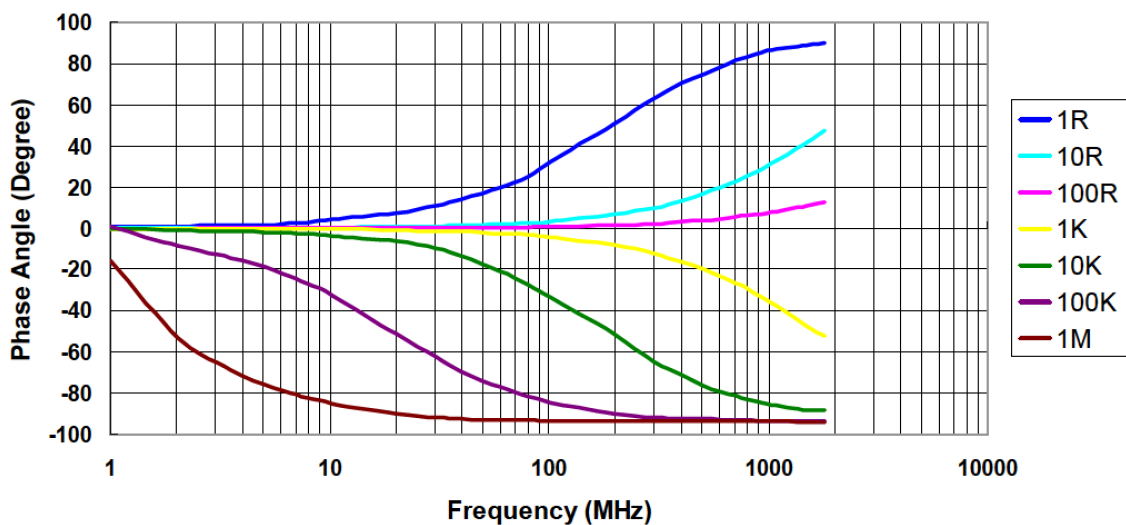

Frequency vs. Impedance
CSR Series (MCFRFTDU)

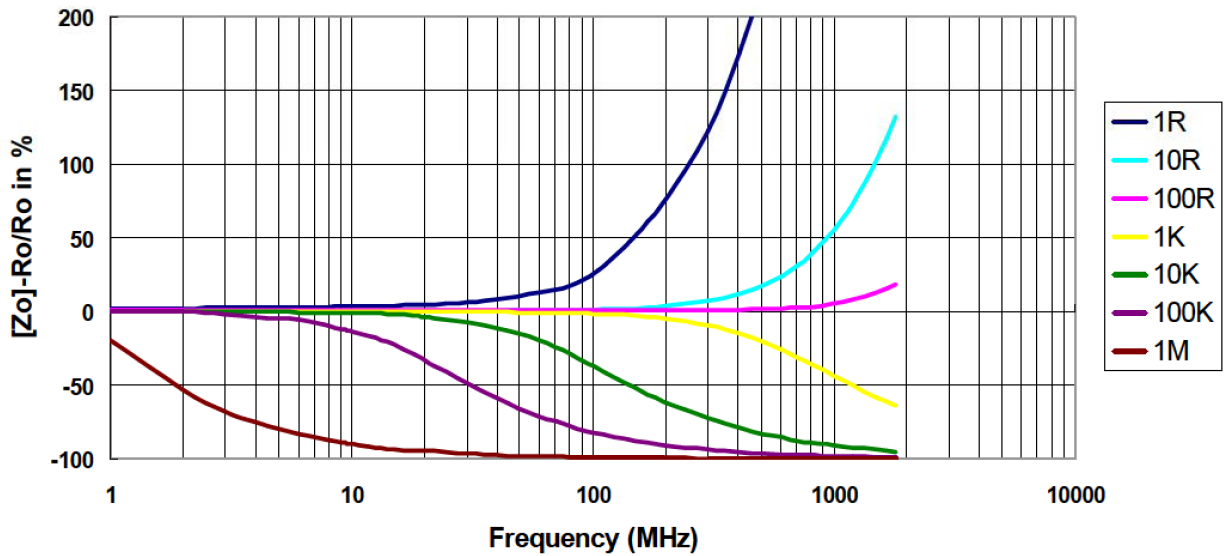

Frequency vs. Phase Angle
CSR Series (MCFRFTDU)

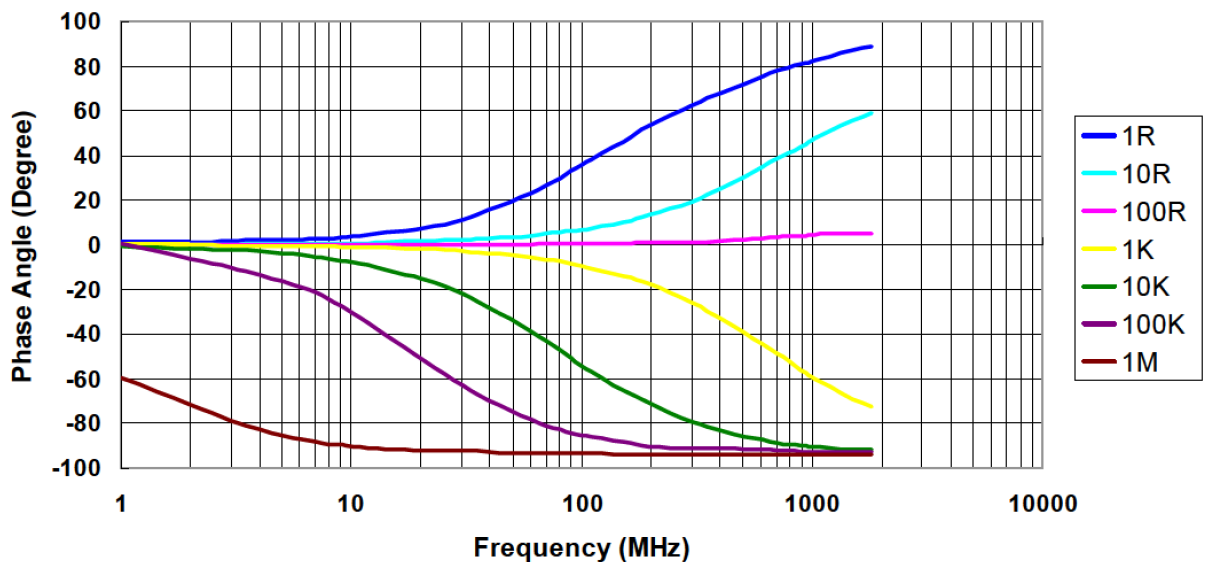

Lightning Surge

Resistors are tested in accordance with IEC 60 115-1 using both 1.2 / 50µs and 10 / 700µs pulse shapes. The limit of acceptance is a shift in resistance of less than 0.5% from the initial value.

1.2 / 50µs Lightning Surge

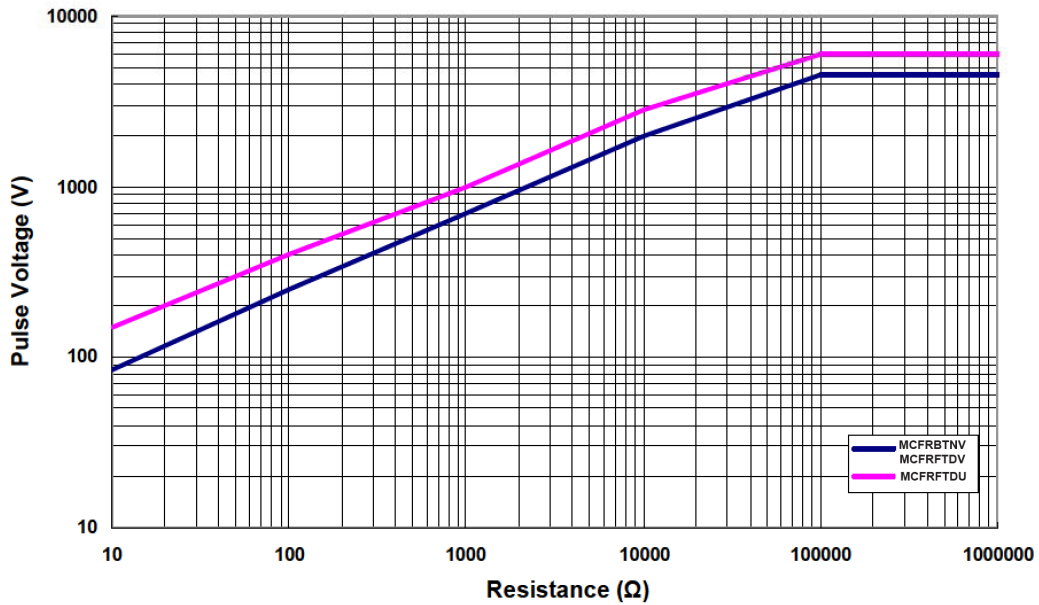

10 / 700µs Lightning Surge

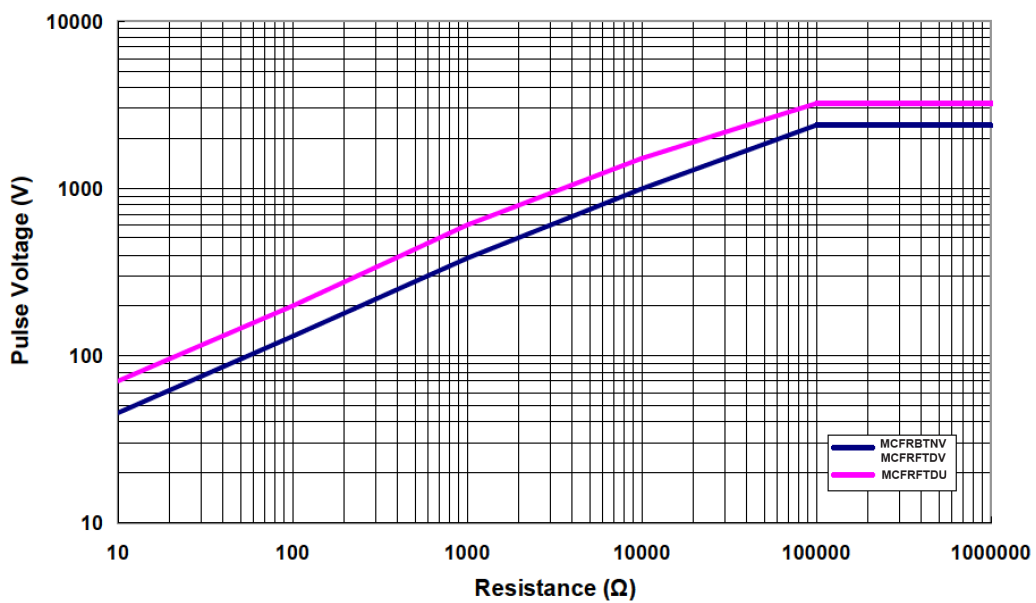

Metal Film Precision Resistors

CSR Series

multicomp PRO

Part Number Table

Description	Part Number
Resistor, Melf, 0R0, 0.25W	MCFRFT-VR0R0
Resistor, Melf, 51R, 0.1%, 0.25W	MCFRBTNV0510
Resistor, Melf, 56R, 0.1%, 0.25W	MCFRBTNV0560
Resistor, Melf, 62R, 0.1%, 0.25W	MCFRBTNV0620
Resistor, Melf, 68R, 0.1%, 0.25W	MCFRBTNV0680
Resistor, Melf, 75R, 0.1%, 0.25W	MCFRBTNV0750
Resistor, Melf, 82R, 0.1%, 0.25W	MCFRBTNV0820
Resistor, Melf, 91R, 0.1%, 0.25W	MCFRBTNV0910
Resistor, Melf, 100R, 0.1%, 0.25W	MCFRBTNV1000
Resistor, Melf, 110R, 0.1%, 0.25W	MCFRBTNV1100
Resistor, Melf, 120R, 0.1%, 0.25W	MCFRBTNV1200
Resistor, Melf, 130R, 0.1%, 0.25W	MCFRBTNV1300
Resistor, Melf, 150R, 0.1%, 0.25W	MCFRBTNV1500
Resistor, Melf, 160R, 0.1%, 0.25W	MCFRBTNV1600
Resistor, Melf, 180R, 0.1%, 0.25W	MCFRBTNV1800
Resistor, Melf, 200R, 0.1%, 0.25W	MCFRBTNV2000
Resistor, Melf, 220R, 0.1%, 0.25W	MCFRBTNV2200
Resistor, Melf, 240R, 0.1%, 0.25W	MCFRBTNV2400
Resistor, Melf, 270R, 0.1%, 0.25W	MCFRBTNV2700
Resistor, Melf, 300R, 0.1%, 0.25W	MCFRBTNV3000
Resistor, Melf, 330R, 0.1%, 0.25W	MCFRBTNV3300
Resistor, Melf, 360R, 0.1%, 0.25W	MCFRBTNV3600
Resistor, Melf, 390R, 0.1%, 0.25W	MCFRBTNV3900
Resistor, Melf, 430R, 0.1%, 0.25W	MCFRBTNV4300
Resistor, Melf, 470R, 0.1%, 0.25W	MCFRBTNV4700
Resistor, Melf, 510R, 0.1%, 0.25W	MCFRBTNV5100
Resistor, Melf, 560R, 0.1%, 0.25W	MCFRBTNV5600
Resistor, Melf, 620R, 0.1%, 0.25W	MCFRBTNV6200
Resistor, Melf, 680R, 0.1%, 0.25W	MCFRBTNV6800
Resistor, Melf, 750R, 0.1%, 0.25W	MCFRBTNV7500
Resistor, Melf, 820R, 0.1%, 0.25W	MCFRBTNV8200
Resistor, Melf, 910R, 0.1%, 0.25W	MCFRBTNV9100
Resistor, Melf, 1K, 0.1%, 0.25W	MCFRBTNV1001
Resistor, Melf, 1K1, 0.1%, 0.25W	MCFRBTNV1101
Resistor, Melf, 1K2, 0.1%, 0.25W	MCFRBTNV1201
Resistor, Melf, 1K3, 0.1%, 0.25W	MCFRBTNV1301
Resistor, Melf, 1K5, 0.1%, 0.25W	MCFRBTNV1501

Description	Part Number
Resistor, Melf, 1K6, 0.1%, 0.25W	MCFRBTNV1601
Resistor, Melf, 1K8, 0.1%, 0.25W	MCFRBTNV1801
Resistor, Melf, 2K, 0.1%, 0.25W	MCFRBTNV2001
Resistor, Melf, 2K2, 0.1%, 0.25W	MCFRBTNV2201
Resistor, Melf, 2K4, 0.1%, 0.25W	MCFRBTNV2401
Resistor, Melf, 2K7, 0.1%, 0.25W	MCFRBTNV2701
Resistor, Melf, 3K, 0.1%, 0.25W	MCFRBTNV3001
Resistor, Melf, 3K3, 0.1%, 0.25W	MCFRBTNV3301
Resistor, Melf, 3K6, 0.1%, 0.25W	MCFRBTNV3601
Resistor, Melf, 3K9, 0.1%, 0.25W	MCFRBTNV3901
Resistor, Melf, 4K3, 0.1%, 0.25W	MCFRBTNV4301
Resistor, Melf, 4K7, 0.1%, 0.25W	MCFRBTNV4701
Resistor, Melf, 5K1, 0.1%, 0.25W	MCFRBTNV5101
Resistor, Melf, 5K6, 0.1%, 0.25W	MCFRBTNV5601
Resistor, Melf, 6K2, 0.1%, 0.25W	MCFRBTNV6201
Resistor, Melf, 6K8, 0.1%, 0.25W	MCFRBTNV6801
Resistor, Melf, 7K5, 0.1%, 0.25W	MCFRBTNV7501
Resistor, Melf, 8K2, 0.1%, 0.25W	MCFRBTNV8201
Resistor, Melf, 9K1, 0.1%, 0.25W	MCFRBTNV9101
Resistor, Melf, 10K, 0.1%, 0.25W	MCFRBTNV1002
Resistor, Melf, 11K, 0.1%, 0.25W	MCFRBTNV1102
Resistor, Melf, 12K, 0.1%, 0.25W	MCFRBTNV1202
Resistor, Melf, 13K, 0.1%, 0.25W	MCFRBTNV1302
Resistor, Melf, 15K, 0.1%, 0.25W	MCFRBTNV1502
Resistor, Melf, 16K, 0.1%, 0.25W	MCFRBTNV1602
Resistor, Melf, 18K, 0.1%, 0.25W	MCFRBTNV1802
Resistor, Melf, 20K, 0.1%, 0.25W	MCFRBTNV2002
Resistor, Melf, 22K, 0.1%, 0.25W	MCFRBTNV2202
Resistor, Melf, 24K, 0.1%, 0.25W	MCFRBTNV2402
Resistor, Melf, 27K, 0.1%, 0.25W	MCFRBTNV2702
Resistor, Melf, 30K, 0.1%, 0.25W	MCFRBTNV3002
Resistor, Melf, 33K, 0.1%, 0.25W	MCFRBTNV3302
Resistor, Melf, 36K, 0.1%, 0.25W	MCFRBTNV3602
Resistor, Melf, 39K, 0.1%, 0.25W	MCFRBTNV3902
Resistor, Melf, 43K, 0.1%, 0.25W	MCFRBTNV4302
Resistor, Melf, 47K, 0.1%, 0.25W	MCFRBTNV4702
Resistor, Melf, 51K, 0.1%, 0.25W	MCFRBTNV5102

Newark.com/multicomp-pro
 Farnell.com/multicomp-pro
 Element14.com/multicomp-pro

multicomp PRO

Metal Film Precision Resistors

CSR Series

multicomp PRO

Description	Part Number
Resistor, Melf, 56K, 0.1%, 0.25W	MCFRBTN5602
Resistor, Melf, 62K, 0.1%, 0.25W	MCFRBTN6202
Resistor, Melf, 68K, 0.1%, 0.25W	MCFRBTN6802
Resistor, Melf, 75K, 0.1%, 0.25W	MCFRBTN7502
Resistor, Melf, 82K, 0.1%, 0.25W	MCFRBTN8202
Resistor, Melf, 91K, 0.1%, 0.25W	MCFRBTN9102
Resistor, Melf, 100K, 0.1%, 0.25W	MCFRBTN1003
Resistor, Melf, 110K, 0.1%, 0.25W	MCFRBTN1103
Resistor, Melf, 120K, 0.1%, 0.25W	MCFRBTN1203
Resistor, Melf, 130K, 0.1%, 0.25W	MCFRBTN1303
Resistor, Melf, 150K, 0.1%, 0.25W	MCFRBTN1503
Resistor, Melf, 160K, 0.1%, 0.25W	MCFRBTN1603
Resistor, Melf, 180K, 0.1%, 0.25W	MCFRBTN1803
Resistor, Melf, 200K, 0.1%, 0.25W	MCFRBTN2003
Resistor, Melf, 220K, 0.1%, 0.25W	MCFRBTN2203
Resistor, Melf, 1R, 1%, 0.25W	MCFRFTDV1R00
Resistor, Melf, 1R2, 1%, 0.25W	MCFRFTDV1R20
Resistor, Melf, 1R5, 1%, 0.25W	MCFRFTDV1R50
Resistor, Melf, 1R8, 1%, 0.25W	MCFRFTDV1R80
Resistor, Melf, 2R2, 1%, 0.25W	MCFRFTDV2R20
Resistor, Melf, 2R7, 1%, 0.25W	MCFRFTDV2R70
Resistor, Melf, 3R3, 1%, 0.25W	MCFRFTDV3R30
Resistor, Melf, 3R9, 1%, 0.25W	MCFRFTDV3R90
Resistor, Melf, 4R7, 1%, 0.25W	MCFRFTDV4R70
Resistor, Melf, 5R6, 1%, 0.25W	MCFRFTDV5R60
Resistor, Melf, 6R8, 1%, 0.25W	MCFRFTDV6R80
Resistor, Melf, 8R2, 1%, 0.25W	MCFRFTDV8R20
Resistor, Melf, 10R, 1%, 0.25W	MCFRFTDV0100
Resistor, Melf, 12R, 1%, 0.25W	MCFRFTDV0120
Resistor, Melf, 15R, 1%, 0.25W	MCFRFTDV0150
Resistor, Melf, 18R, 1%, 0.25W	MCFRFTDV0180
Resistor, Melf, 22R, 1%, 0.25W	MCFRFTDV0220
Resistor, Melf, 27R, 1%, 0.25W	MCFRFTDV0270
Resistor, Melf, 33R, 1%, 0.25W	MCFRFTDV0330
Resistor, Melf, 39R, 1%, 0.25W	MCFRFTDV0390
Resistor, Melf, 47R, 1%, 0.25W	MCFRFTDV0470
Resistor, Melf, 56R, 1%, 0.25W	MCFRFTDV0560

Description	Part Number
Resistor, Melf, 68R, 1%, 0.25W	MCFRFTDV0680
Resistor, Melf, 82R, 1%, 0.25W	MCFRFTDV0820
Resistor, Melf, 100R, 1%, 0.25W	MCFRFTDV1000
Resistor, Melf, 120R, 1%, 0.25W	MCFRFTDV1200
Resistor, Melf, 150R, 1%, 0.25W	MCFRFTDV1500
Resistor, Melf, 180R, 1%, 0.25W	MCFRFTDV1800
Resistor, Melf, 220R, 1%, 0.25W	MCFRFTDV2200
Resistor, Melf, 270R, 1%, 0.25W	MCFRFTDV2700
Resistor, Melf, 330R, 1%, 0.25W	MCFRFTDV3300
Resistor, Melf, 390R, 1%, 0.25W	MCFRFTDV3900
Resistor, Melf, 470R, 1%, 0.25W	MCFRFTDV4700
Resistor, Melf, 560R, 1%, 0.25W	MCFRFTDV5600
Resistor, Melf, 680R, 1%, 0.25W	MCFRFTDV6800
Resistor, Melf, 820R, 1%, 0.25W	MCFRFTDV8200
Resistor, Melf, 1K, 1%, 0.25W	MCFRFTDV1001
Resistor, Melf, 1K2, 1%, 0.25W	MCFRFTDV1201
Resistor, Melf, 1K5, 1%, 0.25W	MCFRFTDV1501
Resistor, Melf, 1K8, 1%, 0.25W	MCFRFTDV1801
Resistor, Melf, 2K2, 1%, 0.25W	MCFRFTDV2201
Resistor, Melf, 2K7, 1%, 0.25W	MCFRFTDV2701
Resistor, Melf, 3K3, 1%, 0.25W	MCFRFTDV3301
Resistor, Melf, 3K9, 1%, 0.25W	MCFRFTDV3901
Resistor, Melf, 4K7, 1%, 0.25W	MCFRFTDV4701
Resistor, Melf, 5K6, 1%, 0.25W	MCFRFTDV5601
Resistor, Melf, 6K8, 1%, 0.25W	MCFRFTDV6801
Resistor, Melf, 8K2, 1%, 0.25W	MCFRFTDV8201
Resistor, Melf, 10K, 1%, 0.25W	MCFRFTDV1002
Resistor, Melf, 12K, 1%, 0.25W	MCFRFTDV1202
Resistor, Melf, 15K, 1%, 0.25W	MCFRFTDV1502
Resistor, Melf, 18K, 1%, 0.25W	MCFRFTDV1802
Resistor, Melf, 22K, 1%, 0.25W	MCFRFTDV2202
Resistor, Melf, 27K, 1%, 0.25W	MCFRFTDV2702
Resistor, Melf, 33K, 1%, 0.25W	MCFRFTDV3302
Resistor, Melf, 39K, 1%, 0.25W	MCFRFTDV3902
Resistor, Melf, 47K, 1%, 0.25W	MCFRFTDV4702
Resistor, Melf, 56K, 1%, 0.25W	MCFRFTDV5602
Resistor, Melf, 68K, 1%, 0.25W	MCFRFTDV6802

Newark.com/multicomp-pro
 Farnell.com/multicomp-pro
 Element14.com/multicomp-pro

multicomp PRO

Metal Film Precision Resistors

CSR Series

multicomp PRO

Description	Part Number
Resistor, Melf, 82K, 1%, 0.25W	MCFRFTDV8202
Resistor, Melf, 100K, 1%, 0.25W	MCFRFTDV1003
Resistor, Melf, 120K, 1%, 0.25W	MCFRFTDV1203
Resistor, Melf, 150K, 1%, 0.25W	MCFRFTDV1503
Resistor, Melf, 180K, 1%, 0.25W	MCFRFTDV1803
Resistor, Melf, 220K, 1%, 0.25W	MCFRFTDV2203
Resistor, Melf, 270K, 1%, 0.25W	MCFRFTDV2703
Resistor, Melf, 330K, 1%, 0.25W	MCFRFTDV3303
Resistor, Melf, 390K, 1%, 0.25W	MCFRFTDV3903
Resistor, Melf, 470K, 1%, 0.25W	MCFRFTDV4703
Resistor, Melf, 560K, 1%, 0.25W	MCFRFTDV5603
Resistor, Melf, 680K, 1%, 0.25W	MCFRFTDV6803
Resistor, Melf, 820K, 1%, 0.25W	MCFRFTDV8203
Resistor, Melf, 1M, 1%, 0.25W	MCFRFTDV1004
Resistor, Melf, 1M2, 1%, 0.25W	MCFRFTDV1204
Resistor, Melf, 1M5, 1%, 0.25W	MCFRFTDV1504
Resistor, Melf, 1M8, 1%, 0.25W	MCFRFTDV1804
Resistor, Melf, 2M2, 1%, 0.25W	MCFRFTDV2204
Resistor, Melf, 2M7, 1%, 0.25W	MCFRFTDV2704
Resistor, Melf, 3M3, 1%, 0.25W	MCFRFTDV3304
Resistor, Melf, 3M9, 1%, 0.25W	MCFRFTDV3904
Resistor, Melf, 4M7, 1%, 0.25W	MCFRFTDV4704
Resistor, Melf, 0R0, 0.5W	MCFRFT-UR0R0
Resistor, Melf, 1R, 1%, 0.5W	MCFRFTDU1R00
Resistor, Melf, 1R2, 1%, 0.5W	MCFRFTDU1R20
Resistor, Melf, 1R5, 1%, 0.5W	MCFRFTDU1R50
Resistor, Melf, 1R8, 1%, 0.5W	MCFRFTDU1R80
Resistor, Melf, 2R2, 1%, 0.5W	MCFRFTDU2R20
Resistor, Melf, 2R7, 1%, 0.5W	MCFRFTDU2R70
Resistor, Melf, 3R3, 1%, 0.5W	MCFRFTDU3R30
Resistor, Melf, 3R9, 1%, 0.5W	MCFRFTDU3R90
Resistor, Melf, 4R7, 1%, 0.5W	MCFRFTDU4R70
Resistor, Melf, 6R8, 1%, 0.5W	MCFRFTDU6R80
Resistor, Melf, 8R2, 1%, 0.5W	MCFRFTDU8R20
Resistor, Melf, 10R, 1%, 0.5W	MCFRFTDU0100
Resistor, Melf, 12R, 1%, 0.5W	MCFRFTDU0120

Description	Part Number
Resistor, Melf, 15R, 1%, 0.5W	MCFRFTDU0150
Resistor, Melf, 18R, 1%, 0.5W	MCFRFTDU0180
Resistor, Melf, 33R, 1%, 0.5W	MCFRFTDU0330
Resistor, Melf, 39R, 1%, 0.5W	MCFRFTDU0390
Resistor, Melf, 47R, 1%, 0.5W	MCFRFTDU0470
Resistor, Melf, 56R, 1%, 0.5W	MCFRFTDU0560
Resistor, Melf, 68R, 1%, 0.5W	MCFRFTDU0680
Resistor, Melf, 82R, 1%, 0.5W	MCFRFTDU0820
Resistor, Melf, 100R, 1%, 0.5W	MCFRFTDU1000
Resistor, Melf, 120R, 1%, 0.5W	MCFRFTDU1200
Resistor, Melf, 150R, 1%, 0.5W	MCFRFTDU1500
Resistor, Melf, 180R, 1%, 0.5W	MCFRFTDU1800
Resistor, Melf, 220R, 1%, 0.5W	MCFRFTDU2200
Resistor, Melf, 270R, 1%, 0.5W	MCFRFTDU2700
Resistor, Melf, 330R, 1%, 0.5W	MCFRFTDU3300
Resistor, Melf, 390R, 1%, 0.5W	MCFRFTDU3900
Resistor, Melf, 470R, 1%, 0.5W	MCFRFTDU4700
Resistor, Melf, 560R, 1%, 0.5W	MCFRFTDU5600
Resistor, Melf, 680R, 1%, 0.5W	MCFRFTDU6800
Resistor, Melf, 820R, 1%, 0.5W	MCFRFTDU8200
Resistor, Melf, 1K, 1%, 0.5W	MCFRFTDU1001
Resistor, Melf, 1K2, 1%, 0.5W	MCFRFTDU1201
Resistor, Melf, 1K5, 1%, 0.5W	MCFRFTDU1501
Resistor, Melf, 1K8, 1%, 0.5W	MCFRFTDU1801
Resistor, Melf, 2K2, 1%, 0.5W	MCFRFTDU2201
Resistor, Melf, 2K7, 1%, 0.5W	MCFRFTDU2701
Resistor, Melf, 3K3, 1%, 0.5W	MCFRFTDU3301
Resistor, Melf, 3K9, 1%, 0.5W	MCFRFTDU3901
Resistor, Melf, 4K7, 1%, 0.5W	MCFRFTDU4701
Resistor, Melf, 5K6, 1%, 0.5W	MCFRFTDU5601
Resistor, Melf, 6K8, 1%, 0.5W	MCFRFTDU6801
Resistor, Melf, 8K2, 1%, 0.5W	MCFRFTDU8201
Resistor, Melf, 10K, 1%, 0.5W	MCFRFTDU1002
Resistor, Melf, 12K, 1%, 0.5W	MCFRFTDU1202
Resistor, Melf, 15K, 1%, 0.5W	MCFRFTDU1502
Resistor, Melf, 18K, 1%, 0.5W	MCFRFTDU1802

Metal Film Precision Resistors

CSR Series



Description	Part Number
Resistor, Melf, 22K, 1%, 0.5W	MCFRFTDU2202
Resistor, Melf, 27K, 1%, 0.5W	MCFRFTDU2702
Resistor, Melf, 33K, 1%, 0.5W	MCFRFTDU3302
Resistor, Melf, 39K, 1%, 0.5W	MCFRFTDU3902
Resistor, Melf, 47K, 1%, 0.5W	MCFRFTDU4702
Resistor, Melf, 56K, 1%, 0.5W	MCFRFTDU5602
Resistor, Melf, 68K, 1%, 0.5W	MCFRFTDU6802
Resistor, Melf, 82K, 1%, 0.5W	MCFRFTDU8202
Resistor, Melf, 100K, 1%, 0.5W	MCFRFTDU1003
Resistor, Melf, 120K, 1%, 0.5W	MCFRFTDU1203
Resistor, Melf, 150K, 1%, 0.5W	MCFRFTDU1503
Resistor, Melf, 180K, 1%, 0.5W	MCFRFTDU1803
Resistor, Melf, 220K, 1%, 0.5W	MCFRFTDU2203
Resistor, Melf, 270K, 1%, 0.5W	MCFRFTDU2703
Resistor, Melf, 330K, 1%, 0.5W	MCFRFTDU3303

Description	Part Number
Resistor, Melf, 390K, 1%, 0.5W	MCFRFTDU3903
Resistor, Melf, 470K, 1%, 0.5W	MCFRFTDU4703
Resistor, Melf, 560K, 1%, 0.5W	MCFRFTDU5603
Resistor, Melf, 680K, 1%, 0.5W	MCFRFTDU6803
Resistor, Melf, 820K, 1%, 0.5W	MCFRFTDU8203
Resistor, Melf, 1M, 1%, 0.5W	MCFRFTDU1004
Resistor, Melf, 1M2, 1%, 0.5W	MCFRFTDU1204
Resistor, Melf, 1M5, 1%, 0.5W	MCFRFTDU1504
Resistor, Melf, 1M8, 1%, 0.5W	MCFRFTDU1804
Resistor, Melf, 2M2, 1%, 0.5W	MCFRFTDU2204
Resistor, Melf, 3M3, 1%, 0.5W	MCFRFTDU3304
Resistor, Melf, 4M7, 1%, 0.5W	MCFRFTDU4704
Resistor, Melf, 5M6, 1%, 0.5W	MCFRFTDU5604
Resistor, Melf, 6M8, 1%, 0.5W	MCFRFTDU6804
Resistor, Melf, 8M2, 1%, 0.5W	MCFRFTDU8204
Resistor, Melf, 22R, 1%, 0.5W	MCFRFTDU0220

Important Notice : This data sheet and its contents (the "Information") belong to the members of the AVNET group of companies (the "Group") or are licensed to it. No licence is granted for the use of it other than for information purposes in connection with the products to which it relates. No licence of any intellectual property rights is granted. The Information is subject to change without notice and replaces all data sheets previously supplied. The Information supplied is believed to be accurate but the Group assumes no responsibility for its accuracy or completeness, any error in or omission from it or for any use made of it. Users of this data sheet should check for themselves the Information and the suitability of the products for their purpose and not make any assumptions based on information included or omitted. Liability for loss or damage resulting from any reliance on the Information or use of it (including liability resulting from negligence or where the Group was aware of the possibility of such loss or damage arising) is excluded. This will not operate to limit or restrict the Group's liability for death or personal injury resulting from its negligence. Multicomp Pro is the registered trademark of Premier Farnell Limited 2019.

Newark.com/multicomp-pro
 Farnell.com/multicomp-pro
 Element14.com/multicomp-pro

