

Metal Film Precision Resistor Jumper

multicomp PRO

**RoHS
Compliant**



Features

- Excellent overall stability
- Tight tolerance down to $\pm 0.1\%$
- Extremely low TCR down to ± 10 PPM/ $^{\circ}\text{C}$
- High power rating up to 1 Watts

Applications

- Telecommunication
- Medical Equipment
- Measurement / Testing Equipment

Construction

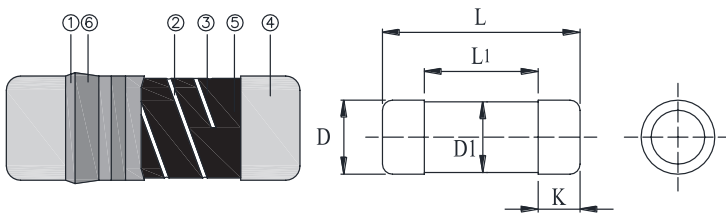

| | | | |
|---|--------------------|---|----------------------------|
| ① | Insulation Coating | ④ | Electrode Cap (Fe, Cu, Sn) |
| ② | Trimming Line | ⑤ | Resistor Layer |
| ③ | Ceramic Road | ⑥ | Marking |

Dimensions

| Part Number | L | L ₁ | ØD | ØD ₁ | K | Weight (1,000ER) (g) |
|--------------|----------------|----------------|-----------------|-----------------|---------------|----------------------|
| MCFRJT-UR0R0 | 5.90 \pm 0.2 | 2.9 | 2.20 \pm 0.20 | D +0/-0.2 | 1.3 \pm 0.1 | 80.9 |

Dimensions : Millimetres

Derating Curve

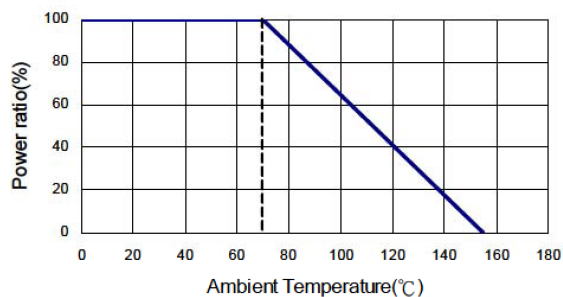

Newark.com/multicomp-pro
Farnell.com/multicomp-pro
Element14.com/multicomp-pro

multicomp PRO

Metal Film Precision Resistor Jumper

multicomp PRO

Standard Electrical Specifications

| Item Size | Power Rating at 70°C | Operating Temp. Range | Max. Operating Voltage | Max. Overload Voltage | Resistance Range | TCR (PPM/°C) |
|--------------|----------------------------|-----------------------------|------------------------------|-----------------------------|---------------------|-----------------|
| | | | | | ±5% | |
| 0207 | 1/2W | -55 ~ +155°C | 300V | 500V | 0Ω (<15mΩ) | - |
| | Jumper: 4A | | | | | |

Environmental Characteristics

| Item | Requirement | | Test Method |
|---|--|--------|---|
| | 5% and Below% | Jumper | |
| Temperature Coef- ficient of Resistance (T.C.R.) | As Spec | | JIS-C-5201-1 4.8 IEC 60115-1 4.8 -55°C ~ +125°C, 25°C is the reference temperature |
| Short Time Over- load | ±(0.15% + 0.05Ω) | <15mΩ | JIS-C-5201-1 4.13 IEC-60115-1 4.13 RCWV × 2.5 or Max. overload voltage for 5 seconds |
| Insulation Resist- ance | ≥ 10G | | JIS-C-5201-1 4.6 IEC-60115-1 4.6 Max.overload voltage for 1minute |
| Endurance | ±(0.5% + 0.05Ω) | <15mΩ | JIS-C-5201-1 4.25 IEC-60115-1 4.25.1 70 ±2°C, Max. RCWV for 1,000 hrs with 1.5 hrs "ON" and 0.5 hr "OFF" |
| Damp Heat with Load | ±(1.0% + 0.05Ω) | <15mΩ | JIS-C-5201-1 4.24 IEC-60115-1 4.24 40 ±2°C, 90 ~ 95% R.H. Max. RCWV for 1,000 hrs with 1.5 hrs "ON" and 0.5 hr "OFF" |
| Dry Heat | ±(1.0% + 0.05Ω) | <15mΩ | JIS-C-5201-1 4.23 IEC-60115-1 2.23.2 at +155°C for 1,000 hrs |
| Bending Strength | ±(0.5% + 0.05Ω) | <15mΩ | JIS-C-5201-1 4.33 IEC 60115-1 4.33 Bending once for 5 seconds with 2mm |
| Solderability | 95% min. Coverage | | JIS-C-5201-1 4.17 IEC 60115-1 4.17 245 ±5°C for 3 seconds |
| Resistance to Soldering Heat | ±(0.5% + 0.05Ω) | <15mΩ | JIS-C-5201-1 4.18 IEC 60115-1 4.18 260 ±5°C for 10 seconds |
| Voltage Proof | No breakdown or flashover | | JIS-C-5201-1 4.7 IEC 60115-1 4.7 1.42 times Max. Operating Voltage for 1minute |
| Leaching | Individual leaching area ≤ 5% Total leaching area ≤ 10% | | JIS-C-5201-1 4.18 IEC 60068-2-58 8.2.1 260 ±5°C for 30 seconds |

Newark.com/multicomp-pro
Farnell.com/multicomp-pro
Element14.com/multicomp-pro

multicomp PRO

Metal Film Precision Resistor Jumper

| Item | Requirement | | Test Method |
|-----------------------------|---------------------------|--------------|---|
| | 5% and Below% | Jumper | |
| Rapid Change of Temperature | $\pm(0.5\% + 0.05\Omega)$ | $<15m\Omega$ | JIS-C-5201-1 4.18 IEC 60115-1 4.18 -55°C ~ +155°C, 5 cycles |

RCWV (Rated Continuous Working Voltage) = $\sqrt{P \times R}$ or Max. Operating Voltage whichever is lower

Storage Temperature : $25 \pm 3^\circ\text{C}$; Humidity $< 80\%RH$

Soldering Condition

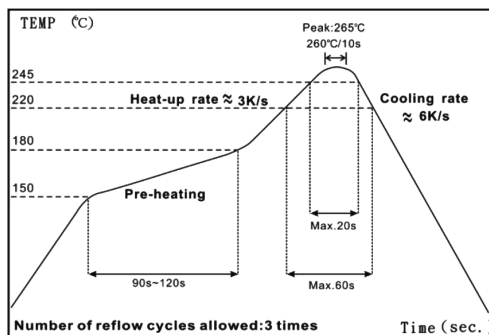

IR Reflow Soldering

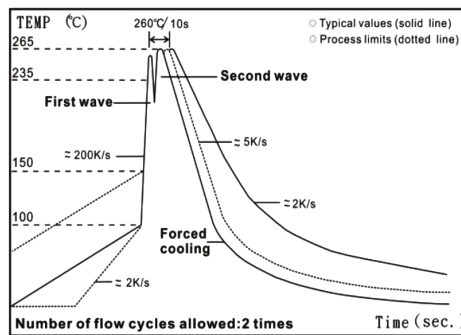

Wave Soldering (For R>10Ω)

1. Time of IR reflow soldering at maximum temperature point 260°C : 10s
2. Time of wave soldering at maximum temperature point 260°C : 10s
3. Time of soldering iron at maximum temperature point 410°C : 5s

Packing

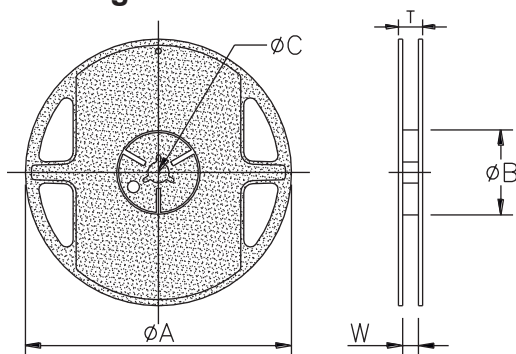

Packing Quantity & Real Specifications

| Part Number | Reel Diameter | ΦA (mm) | ΦB (mm) | ΦC (mm) | W (mm) | T (mm) | Emboss Plastic Tape (EA) |
|--------------|---------------|------------|---------|---------|---------|-----------|--------------------------|
| MCFRJT-UR0R0 | 7 inch | 178.5 ±1.5 | 60 +1 | 13 ±0.5 | 13 ±0.5 | 15.5 ±0.5 | 2,000 |

Metal Film Precision Resistor Jumper

Emboss Plastic Tape Specifications

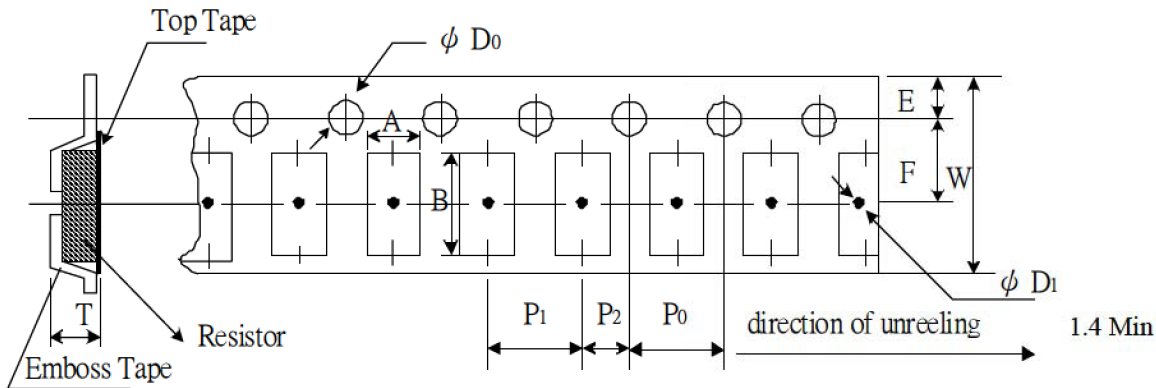

| Part Number | A (mm) | B (mm) | w (mm) | E (mm) | F (mm) | P ₀ (mm) | P ₁ (mm) | P ₂ (mm) | ΦD ₀ (mm) | T (mm) |
|-------------|----------|-----------|---------|-----------|-----------|---------------------|---------------------|---------------------|----------------------|----------|
| MCFRJ-UR0R0 | 2.4 ±0.1 | 6.15 ±0.1 | 12 ±0.1 | 1.75 ±0.1 | 5.5 ±0.05 | 4 ±0.1 | 4 ±0.1 | 2 ±0.05 | 1.5 ±0.1 | 2.7 ±0.1 |

Recommend Land Pattern

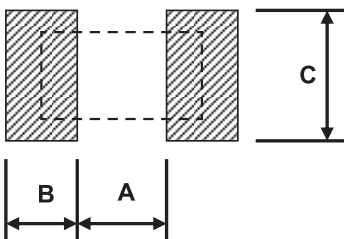

| Part Number | A (mm) | B (mm) | C (mm) |
|-------------|--------|--------|--------|
| MCFRJ-UR0R0 | 3 | 1.7 | 2.4 |

Pulse withstanding capacity

The single impulse graph is the result of 50 impulses of rectangular shape applied at one-minute intervals. The limit of acceptance was a shift in resistance of less than 1% from the initial value. The power applied was subject to the restrictions of the maximum permissible impulse voltage graph shown.

CSR Series Single Pulse (100Ω)

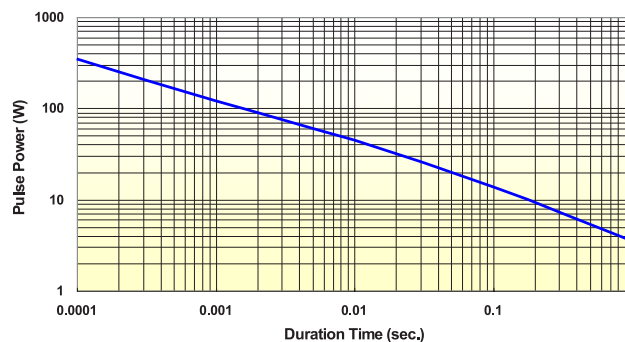

Metal Film Precision Resistor Jumper

Continuous Pulse

The continuous load graph was obtained by applying repetitive rectangular pulses where the pulse period was adjusted so that the average power dissipated in the resistor was equal to its rated power at 70°C. Again the limit of acceptance was a shift in resistance of less than 1% from the initial value.

CSR Series Continuous Pulse (100Ω)

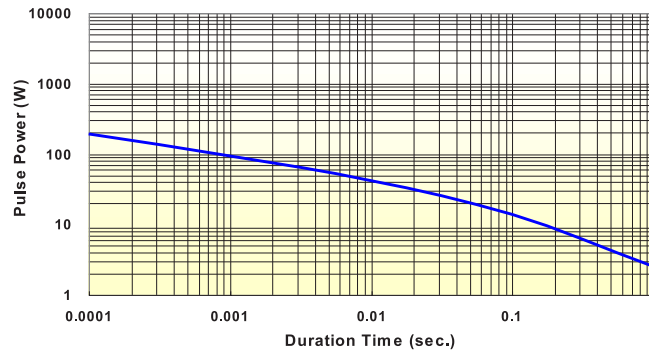

CSR Series Pulse (100Ω)

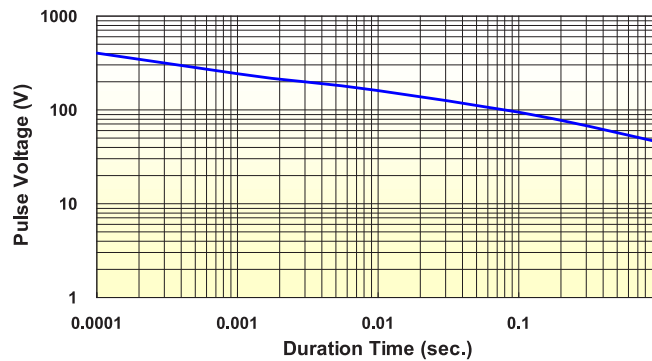

Frequency behavior

Resistors are designed to function according to ohmic laws. This is basically true of resistors for frequencies up to 100KHz. At higher frequencies, there is an additional contribution to the impedance by an ideal resistor switched in series with a coil and both switched parallel to a capacitor. The values of the capacitance and inductance are mainly determined by the dimensions of the terminations and the conductive path length.

The environment surrounding components has a large influence on the behavior of the component on the printed-circuit board.

Frequency vs. Impedance

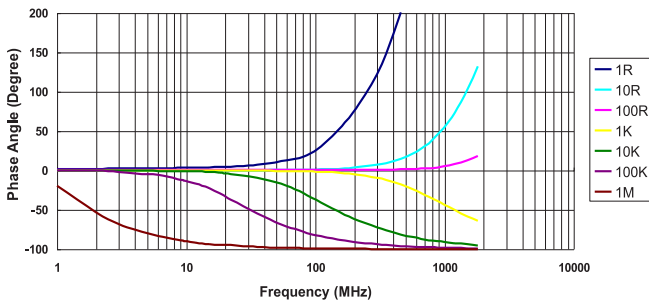

Frequency vs. Phase Angle

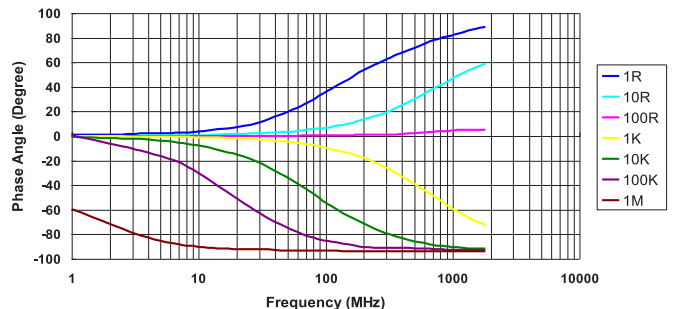

Metal Film Precision Resistor Jumper



Lightning Surge

Resistors are tested in accordance with IEC 60 115-1 using both 1.2 / 50µs and 10 / 700µs pulse shapes. The limit of acceptance is a shift in resistance of less than 0.5% from the initial value.

1.2 / 50µs Lightning Surge

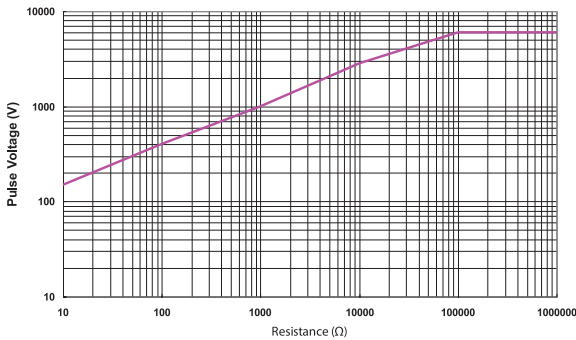

10 / 700µs Lightning Surge

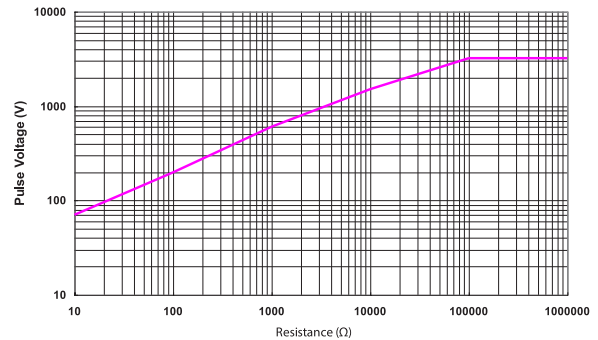

Part Number Table

| Description | Part Number |
|-------------------------------------|--------------|
| Resistor, Metal Film, 0R, ±5%, 0207 | MCFRJT-UR0R0 |

Important Notice : This data sheet and its contents (the "Information") belong to the members of the AVNET group of companies (the "Group") or are licensed to it. No licence is granted for the use of it other than for information purposes in connection with the products to which it relates. No licence of any intellectual property rights is granted. The Information is subject to change without notice and replaces all data sheets previously supplied. The Information supplied is believed to be accurate but the Group assumes no responsibility for its accuracy or completeness, any error in or omission from it or for any use made of it. Users of this data sheet should check for themselves the Information and the suitability of the products for their purpose and not make any assumptions based on information included or omitted. Liability for loss or damage resulting from any reliance on the Information or use of it (including liability resulting from negligence or where the Group was aware of the possibility of such loss or damage arising) is excluded. This will not operate to limit or restrict the Group's liability for death or personal injury resulting from its negligence. Multicomp Pro is the registered trademark of Premier Farnell Limited 2019.

Newark.com/multicomp-pro
 Farnell.com/multicomp-pro
 Element14.com/multicomp-pro

