

A low-profile slide switch with 1.4mm thickness



Detector

Slide

Push

Rotary

Power

Dual-in-line
Package Type

Small size
General Use Type

Big size
General Use Type

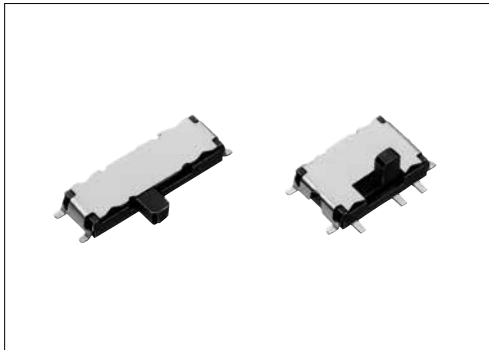

Typical Specifications

Items		Specifications
Rating (max.)/(min.) (Resistive load)		0.3A 5V DC / 50μA 3V DC
Contact resistance (Initial performance / After lifetime)		70mΩ max. / 130mΩ max.
Operating force		Refer to the dimensions.
Operating life	Without load	10,000 cycles 100mΩ max.
	With load	10,000 cycles 130mΩ max. (0.3A 5V DC)

Product Line

Travel (mm)	Actuator direction	Actuator thickness (mm)	Poles	Positions	Changeover timing	Ground terminal	Soldering	Minimum order unit (pcs.)		Products No.	Drawing No.
								Japan	Export		
1.5	Vertical	t0.8	2	2	Not specified	Without	Reflow	1,800	7,200	SSSS820101	1
				3						SSSS820301	2
				2						SSSS820201	1
				3						SSSS820501	2
	Horizontal	t1.1	1	2		Without		4,500	18,000	SSSS810701	3
				3						SSSS811501	4
				2						SSSS811101	3
				3						SSSS812201	4
2				2		With			SSSS810201	5	

Packing Specifications

Taping

Product No.	Number of packages (pcs.)			Reel width W (mm)	Tape width (mm)	Export package measurements (mm)
	1 reel	1 case / Japan	1 case / export packing			
SSSS820101 SSSS820301 SSSS820201 SSSS820501	1,800	3,600	7,200	25.4	24	406×406×190
SSSS810701 SSSS811501 SSSS811101 SSSS812201 SSSS810201	4,500	9,000	18,000	17.4	16	417×409×139

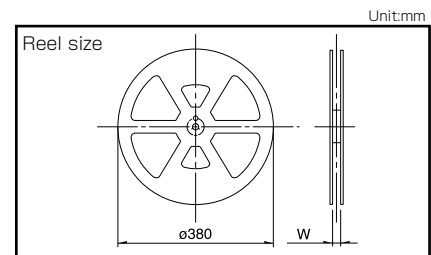

■ Dimensions

Vertical Actuator Type/Horizontal Actuator Type 1.5mm-travel

Unit:mm

No.	Photo	Style	PC board mounting hole and land dimensions (Viewed from direction A)
1		<p>2-pole, 2-position</p> <p>Terminal No.① 0.4 3 1.5 0.75 With ground terminal dimensions</p> <p>Travel 1.5</p> <p>Operating force : 2N</p>	<p>2-ϕ0.9 hole</p> <p>6-pattern section</p> <p>4-pattern section for ground terminal</p>
2		<p>2-pole, 3-position</p> <p>Terminal No.① 1.5 3 1.5 With ground terminal dimensions</p> <p>Travel 1.5</p> <p>Operating force : a \rightarrow b } 2N c \rightarrow b } b \rightarrow a } 2.5N b \rightarrow c }</p>	<p>2-ϕ0.9 hole</p> <p>8-pattern section</p> <p>4-pattern section for ground terminal</p>
3		<p>1-pole, 2-position</p> <p>Terminal No.① 0.4 3 1.5 0.75 With ground terminal dimensions</p> <p>Travel 1.5</p> <p>Operating force : 1.5N</p>	<p>2-ϕ0.9 hole</p> <p>3-pattern section</p> <p>4-pattern section for ground terminal</p>
4		<p>1-pole, 3-position</p> <p>Terminal No.① 1.5 3 1.5 With ground terminal dimensions</p> <p>Travel 1.5</p> <p>Operating force : a \rightarrow b } 1.5N c \rightarrow b } b \rightarrow a } 2N b \rightarrow c }</p>	<p>2-ϕ0.9 hole</p> <p>4-pattern section</p> <p>4-pattern section for ground terminal</p>

Note

Products not marked with * in the drawing have no ground terminal.

SSSS8 1.4(H)mm, 1.5/2mm-travel Surface Mount Type

■ Dimensions

Horizontal Actuator Type 2mm-travel

Unit:mm

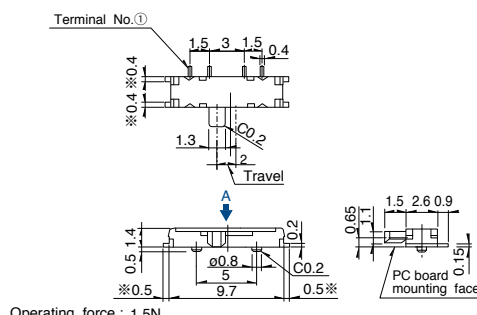
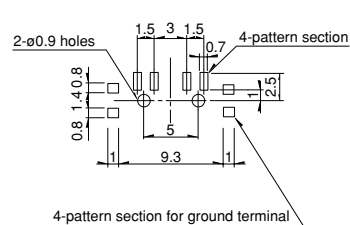
No.	Photo	Style	PC board mounting hole and land dimensions (Viewed from direction A)
5			

Note





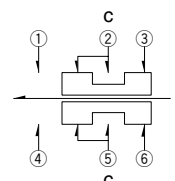
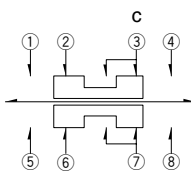
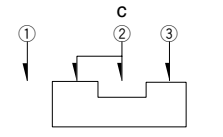
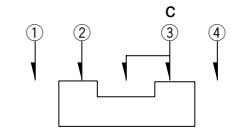
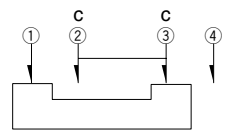







Products not marked with ※ in the drawing have no ground terminal.

■ Circuit Diagram (Viewed from Direction A)

<p>2-pole, 2-position Drawing No.1</p> 	<p>2-pole, 3-position Drawing No.2</p> 	
<p>1-pole, 2-position 1.5mm-travel Drawing No.3</p> 	<p>1-pole, 3-position 1.5mm-travel Drawing No.4</p> 	<p>1-pole, 2-position 2mm-travel Drawing No.5</p> 

Slide Switches

List of Varieties

Series		SSAJ	SSAH	SSSS8	SSAL	SSAG	SSSS7
Photo							
Actuator direction	Horizontal	●	●	●	●	●	●
	Vertical	—	—	●	—	—	—
Poles-positions	1-2	●	—	●	●	—	●
	1-3	—	●	●	—	●	●
	1-4	—	—	—	—	—	—
	2-2	—	—	●	—	—	—
	2-3	—	—	●	—	—	—
	2-4	—	—	—	—	—	—
	4-2	—	—	—	—	—	—
Travel (mm)		1.4	1.5	1.5, 2	2	1.5	2
Operating temperature range		-10°C to +60°C	-30°C to +60°C	-40°C to +85°C	-10°C to +60°C		-40°C to +85°C
Automotive use		—	—	—	—	—	—
Life cycle							
Rating (max.) (Resistive load)		10mA 5V DC	1mA 5V DC	0.3A 5V DC	10mA 5V DC		0.3A 4V DC
Rating (min.) (Resistive load)		50μA 3V DC					
Durability	Operating life without load	10,000 cycles 500mΩ max.	10,000 cycles 300mΩ max.	10,000 cycles 100mΩ max.	100,000 cycles 10Ω max.	30,000 cycles (Lock side) 100,000 cycles (Recoil side) 500mΩ max.	10,000 cycles 100mΩ max.
	Operating life with load Load: as rating			10,000 cycles 130mΩ max.			
Electrical performance	Initial contact resistance	300mΩ max.	200mΩ max.	70mΩ max.	10Ω max.	200mΩ max.	70mΩ max.
	Insulation resistance	100MΩ min. 100V DC					
	Voltage proof	100V AC for 1minute					
Mechanical performance	Terminal strength	3N for 1minute					
	Actuator strength	10N					
Environmental performance	Cold	-40°C 96h		-40°C 500h	-40°C 96h		-20°C 500h
	Dry heat	85°C 96h		85°C 500h	85°C 96h		85°C 500h
	Damp heat	40°C, 90 to 95%RH 96h	60°C, 90 to 95%RH 240h	60°C, 90 to 95%RH 500h	40°C, 90 to 95%RH 96h		60°C, 90 to 95%RH 500h
Page		70	72	74	77	79	82

Slide Switches Soldering Conditions	106
Slide Switches Cautions	107

Note
 ● Indicates applicability to all products in the series.

Example of Reflow Soldering Condition

1. Heating method: Double heating method with infrared heater.
2. Temperature measurement: Thermocouple ϕ 0.1 to 0.2 CA (K) or CC (T) at soldering portion (copper foil surface).
A heat resisting tape should be used for fixed measurement.
3. Temperature profile

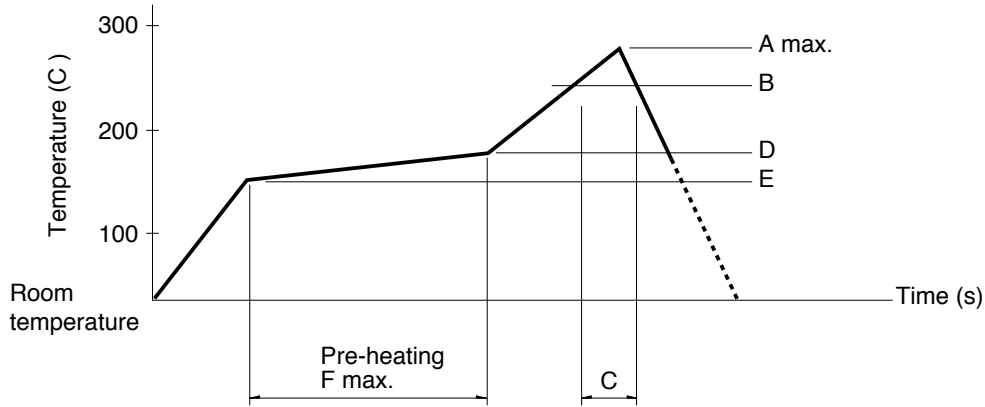

Series (Reflow type)		A (°C) 3s max.	B (°C)	C (s)	D (°C)	E (°C)	F (s)
SSSS2	Vertical 1-pole, 3-position	260	230	40	180	150	120
	Horizontal 1-pole, 2-position 1-pole, 3-position 2-pole, 3-position						
	Vertical 1-pole, 2-position	250					
SSSS7		260					
SSAH, SSAG, SSAJ, SSAL, SSSS8		260					

Notes

1. The condition mentioned above is the temperature on the mounting surface of a PC board. There are cases where the PC board's temperature greatly differs from that of the switch, depending on the PC board's material, size, thickness, etc. The above-stated conditions shall also apply to switch surface temperatures.
2. Soldering conditions differ depending on reflow soldering machines. Prior verification of soldering condition is highly recommended.

Reference for Hand Soldering

Series	Soldering temperature	Soldering time
SSSF, SSSU	350±10°C	3+1/0s
SSSS2	350±10°C	4s max.
SSSS9	350±10°C	3s max.
SSAH, SSAG, SSAJ, SSAL	350±5°C	3s max.
SSSS8	330±5°C	3s max.
SSSS7	320±5°C	3s max.
SSAC	300±10°C	2s max.

Reference for Dip Soldering

(For PC board terminal types)

Series	Items		Dip soldering	
	Preheating temperature	Preheating time	Soldering temperature	Duration of immersion
SSSS2	100°C max.	60s max.	260±5°C	3±1s
SSSS9	120°C max.	60s max.	260±5°C	5+0/-1s (2 times)
SSSF, SSSU	100°C max.	60s max.	260±5°C	10±1s/5±1s
SSAC	100°C max.	60s max.	260±5°C	5±1s