

The SP 5-GFX1 incorporates the latest LCD controller LSI to provide a unique combination of a 128 x 64 pixel display with compact size and ease of use. LED backlighting ensures excellent visibility under low light conditions. The module features a 10-pin single in line connector. The serial data interface ensures that the host microcontrollers can drive the display with a minimum of I/O lines. Easy to install, the module is supplied with a bezel, fixing clip and a rubber seal. The latter provides splashproof protection for the display when fitted

FEATURES

- 128 x 64 Pixels
- High Contrast LCD
- 6 o'clock Viewing Direction
- Yellow-Green LED Backlighting
- Based on Sunplus® SPLC 501C Controller
- Serial Data Interface



Shown actual size

This datasheet should be read in conjunction with the Sunplus SPLC 501C device datasheet. A link to this is available at www.lascarelectronics.com on the SP 5-GFX1 product information page.

ORDERING INFORMATION

Standard Instrument

Stock Number
SP 5-GFX1

ELECTRICAL SPECIFICATIONS

Specification	Min.	Typ.	Max.	Unit
Supply voltage (Pin 2 to Pin 1)	4.5	5.0	5.5	V d.c.
Supply current (Backlight off)		350		µA
Input voltage (Pin 3, 4, 5, 6, 7)	High	0.8V _{DD}	-	V _{DD}
	Low	V _{SS}	-	0.2V _{DD}
Backlight supply voltage (Pin 9 to Pin 8)	-	5	5.5	V d.c.
Backlight supply current	-	50		mA
Operating temperature range	0		50	°C

Consult the Lascar website for the latest **FREE** software components and application ideas. Alternatively, ask Lascar to write your software or program your modules with your code.
www.lascarelectronics.com or
www.mdm1.info

SAFETY

To comply with the Low Voltage Directive (LVD 93/68/EEC), input voltages to the module's connections must not exceed 60Vdc. The user must ensure that the incorporation of the panel instrument into the user's equipment conforms to the relevant sections of BS EN 61010 (Safety Requirements for Electrical Equipment for Measuring, Control and Laboratory Use).

LASCAR ELECTRONICS LTD.
MODULE HOUSE
WHITEPARISH
WILTSHIRE SP5 2SJ
UK
TEL: +44 (1794) 884567
FAX: +44 (1794) 884616
E-mail: sales@lascar.co.uk

LASCAR ELECTRONICS INC.
4258 West 12th Street
Erie
PA 16505
USA
TEL: +1 (814) 835 0621
FAX: +1 (814) 838 8141
E-mail: sales@lascarelectronics.com

LASCAR ELECTRONICS (HK) LTD.
8th FLOOR, CHINA AEROSPACE CENTRE,
143 HOI BUN ROAD,
KWUN TONG, KOWLOON,
HONG KONG
TEL: +852 2389 6502
FAX: +852 2389 6535
E-mail: saleshk@lascar.com.hk

Specifications liable to change without prior warning

SP 5-GFX1

Issue 5

06/2010

S.L.

Applies to SP 5-GFX1/1

DIMENSIONS

All dimensions in mm (inches)

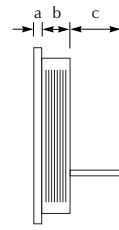
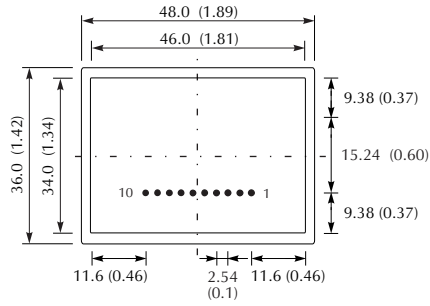
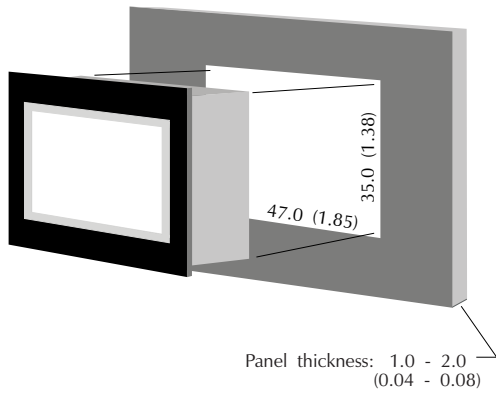

- a. 0.95 (0.04)
- b. 6.5 (0.26)
- c. 8.5 (0.33)

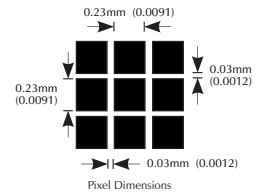
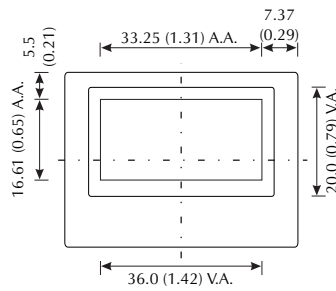

A.A. = Active Area = 128 x 64 Pixels
V.A. = Viewing Area

PANEL FITTING

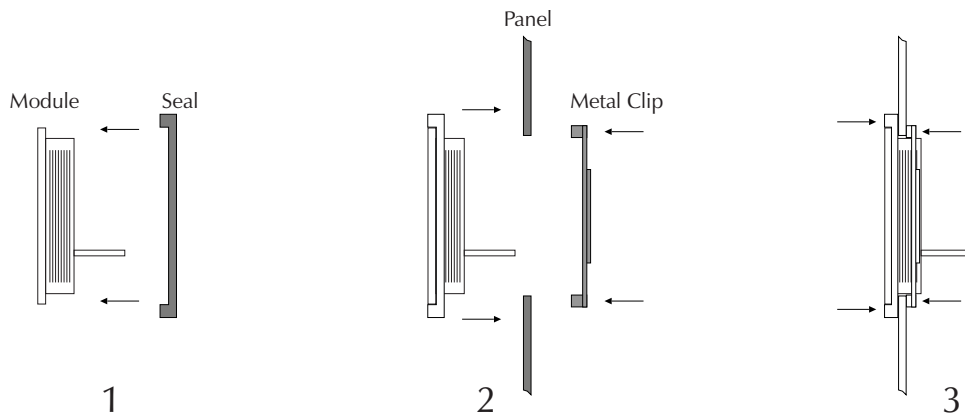

CONNECTIONS (rear view)

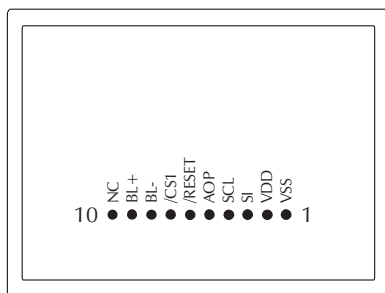

PIN FUNCTIONS

1. V_{SS} Negative power supply connection to the dot matrix display.
2. V_{DD} Positive power supply connection to the dot matrix display.
3. SI Serial data input terminal.
4. SCL Serial clock input terminal.
5. $\overline{A0P}$ Control Data / Display Data flag input. (0=Control Data, 1=Display Data)
6. \overline{RESET} Connect momentarily to 0V to reset the display to its initial settings.
7. CS1 Chip select input. When CS1 is connected to 0V, data and command I/O are enabled.
8. BL- Negative power supply connection to the LED backlighting, electrically isolated from pins 1 and 2.
9. BL+ Positive power connection supply to the LED backlighting, electrically isolated from pins 1 and 2.
10. NC This pin is not used.

APPLICATION

