

PRO-ELEC



LED Floodlight with PIR Models: PEL01282

Please read these instructions carefully before use and retain for future reference.

This floodlights must be installed by a qualified electrician in accordance with current building and IET wiring regulations (BS7671).

IMPORTANT SAFETY INFORMATION

- Do not use PVC cable to connect this floodlight to your wiring supply. Rubberised cable (type H05RN-F), with three conductors of at least 1.0mm² cross-sectional area must be used. This product must be connected to Earth.
- The front of this floodlight is made of tempered glass, replace if cracked.
- LED lamps are extremely bright. To avoid possible damage to the eyes, do not stare into an LED beam.
- In use, avoid touching any external surface of the floodlight, due to the possibility of high temperatures.
- Do not use near flammable materials.
- The floodlight must be positioned so that there is at least 1m between the front of the work light and the surface to be illuminated.
- It is suitable for use in an ambient temperature between -30°C and +45°C. Terminal block is not included. Installation may require advice from qualified personnel.

POSITIONING

- This floodlight is suitable for outdoor lighting applications, for domestic use only.
- Do not use in areas where an explosive or chemical atmosphere may exist. Do not use in areas where ventilation is restricted.
- It is suitable for mounting on plasterboard, wood or masonry surfaces. Highly flammable surfaces such as plastic or polystyrene must not be used.
- Do not install on damp or conductive surfaces such as metal. It should be placed away from any flammable materials.
- Before drilling any fixing holes, check that there are no hidden obstructions behind the mounting surface such as pipes or cables.
- The recommended height for installation of the floodlight is between 0.5 and 3 metres.
- Ensure that there is space around the floodlight to allow adequate circulation of air.
- Orientation of the floodlight is important as shown below:

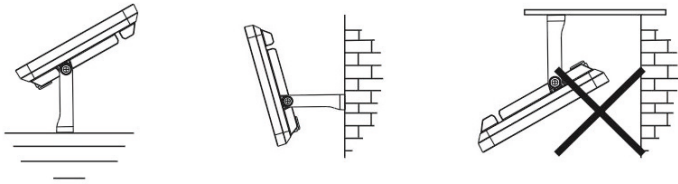

The floodlight has a beam angle of 110° . It can be tilted upwards and downwards at an angle of approximately 90° . The angle of adjustment will vary slightly between models.

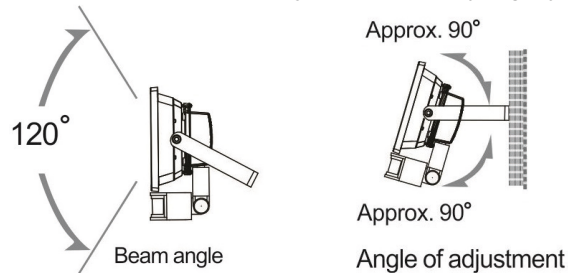

INSTALLATION

The floodlight is suitable for connection to a 220-240V, 50Hz earthed supply. It is designed for permanent connection to fixed wiring, which must be a suitable circuit protected by an RCD with an operating current not exceeding 30mA and an MCB or fuse of the correct rating.

Mounting the Floodlight

- Before commencing installation, check that you have all of the tools you need.
- Check that the floodlight is not damaged. If there is any damage, return it to the place of purchase. Do not attempt to repair it yourself.
- Choose your location to fix the floodlight, taking into account the guidance above.
- Use the floodlight bracket to mark the position of the fixing holes.
- Drill the fixing holes and fix the floodlight into position using appropriate size screws and wall plugs (not provided). Check that it is securely fixed.

Wiring the Floodlight

- Ensure that the mains supply is isolated before commencing installation.
- A suitable IP rated connector must be used to connect the lead from the floodlight to the mains supply.
- Connect the mains cable to the connector. Ensure that the correct polarities for Live, Neutral and Earth are observed i.e.
 - Green/yellow - Earth terminal
 - Brown - Live terminal
 - Blue - Neutral terminal
- After wiring, check that there are no stray strands and that all the wires have been correctly installed.
- Before connecting power, perform the electrical tests specified in the current Building and IET Wiring Regulation to ensure that the installation is safe and that the wiring has been performed correctly.
- Restore the mains power supply and check that the floodlight illuminates the required area. Tighten the floodlight using the bolts on the brackets.

OPERATION

- **Adjusting the PIR Sensor**
- There are three adjustments on the back of the PIR sensor, one adjusts the duration the floodlight remain lit, the second one is for the sensitivity of movement detection and the third is to set the level of ambient light before the sensor triggers the illumination. Some trial and error may be required to set these correctly.
- Adjust the light level so the floodlight doesn't activate until the light level is low enough for floodlighting to be required.
- Adjust the timer setting for the required duration you require the floodlight to remain illuminated.

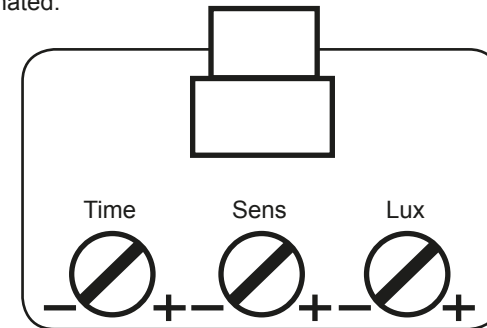

CLEANING & MAINTENANCE

- Clean the floodlight only with a soft dry cloth. Do not use any chemicals, abrasives or solvents that could damage the floodlight.
- The floodlight has a sealed LED lamp and is maintenance free. The LED lamp cannot be replaced. When the LED lamp reaches the end of its life, the floodlight will have to be replaced.

SPECIFICATION

Input Voltage	230V AC 50Hz
Nominal luminous flux	1600lm
Wattage	20W
Equivalent power	104W
Beam angle	110°
Dimmable	No
Nominal lifetime of the lamp	25,000h
Number of switching cycles	12,500
Colour temperature	6000K
Colour rendering (CRI Ra)	≥80
Warm up time (full light)	<1s=100%
Ingress rating	IP44
Dimensions (mm)	155 x 52 x 168
Weight	0.421kg



INFORMATION ON WASTE DISPOSAL FOR CONSUMERS OF ELECTRICAL & ELECTRONIC EQUIPMENT.

When this product has reached the end of its life it must be treated as Waste Electrical & Electronic Equipment (WEEE). Any WEEE marked products must not be mixed with general household waste, but kept separate for the treatment, recovery and recycling of the materials used. Contact your local authority for details of recycling schemes in your area.



Made in China. PR2 9PP

Man Rev 1.0