

mm inch

FEATURES

- **Small size**
The smallest double make type relay
12.0(W)×15.5(L)×13.9(H) mm
.472(W)×.610(L)×.547(H) inch
- **Pattern design simplification**
Simplified pattern design is possible because, while double make construction is employed, the external COM terminal is single.

- **Standard terminal pitch employed**
The terminal array used is identical to that used in JJM relays(1c type).
- **Plastic sealed type**
Plastically sealed for automotive cleaning.

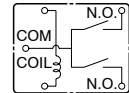

<Schematic>

SPECIFICATIONS

Contact

Arrangement	Double make contact	
Contact material	AgSnO ₂ type	
Initial contact resistance (By voltage drop 6V DC 1A)	Max. 100 mΩ	
Contact voltage drop	Max. 0.25V (at 2 × 6A)	
Rating	Nominal switching capacity	12A 14V DC (at 2 × 6A, lamp load)
	Max. carrying current	2 × 6A (12V, at 20°C 68°F), 2 × 4A (12V, at 85°C 185°F)
	Min. switching capacity ^{#1}	1A 12V DC
Expected life (min. operations)	Mechanical (at 120cpm)	Min. 10 ⁷
	Electrical (lamp load)	Min. 10 ^{5*}

Coil

Nominal operating power	1,000 mW
-------------------------	----------

^{#1} This value can change due to the switching frequency, environmental conditions, and desired reliability level, therefore it is recommended to check this with the actual load.

Remarks

- ^{*1} At 12A 14V DC (lamp), operating frequency: 1s ON, 14s OFF
- ^{*2} Measurement at same location as "initial breakdown voltage" section.
- ^{*3} Detection current: 10mA
- ^{*4} Excluding contact bounce time.
- ^{*5} Half-wave pulse of sine wave: 11 ms; detection time: 10 μs
- ^{*6} Half-wave pulse of sine wave: 6 ms
- ^{*7} Detection time: 10 μs
- ^{*8} Time of vibration for each direction; X, Y direction: 2 hours Z direction: 4 hours



^{*9} Refer to 6. Conditions for operation, transport and storage mentioned in [AMBIENT ENVIRONMENT](#) (p. 19, [Relay Technical Information](#)).

Characteristics

Max. operating speed (at nominal switching capacity)	4 cpm	
Initial insulation resistance ^{*2}	Min. 100 MΩ (at 500 V DC)	
Initial breakdown voltage ^{*3}	Between open contacts	500 Vrms for 1min.
	Between contact and coil	500 Vrms for 1min.
Operate time ^{*4} (at nominal voltage)(at 20°C 68°F)	Max. 10 ms (Initial)	
Release time (without diode) ^{*4} (at nominal voltage)(at 20°C 68°F)	Max. 10 ms (Initial)	
Shock resistance	Functional ^{*5}	Min. 100 m/s ² {10 G}
	Destructive ^{*6}	Min. 1,000 m/s ² {100 G}
Vibration resistance	Functional ^{*7}	10 Hz to 100 Hz, Min. 44.1 m/s ² {4.5 G}
	Destructive ^{*8}	10 Hz to 500 Hz, Min. 44.1 m/s ² {4.5 G}
Conditions in case of operation, transport and storage ^{*9} (Not freezing and condensing at low temperature)	Ambient temp.	-40°C to +85°C -40°F to +185°F
	Humidity	5% R.H. to 85% R.H.
Mass	Approx. 5 g .176 oz	

TYPICAL APPLICATIONS

Car alarm system flashing lamp etc.

ORDERING INFORMATION

Ex. JJM 2w 12V

Contact arrangement	Coil voltage (DC)
Double make contact	12V

Standard packing: Carton (tube package) 50pcs. Case: 1,000pcs.

JJ-M(2w)

TYPES AND COIL DATA (at 20°C 68°F)

• Single side stable type

Part No.	Nominal voltage, V DC	Pick-up voltage, V DC (Initial)	Drop-out voltage, V DC (Initial)	Coil resistance Ω	Nominal operating current, mA	Nominal operating power, mW	Usable voltage range, V DC
JJM2w-12V	12	Max. 6.9	Min. 1.0	144 \pm 10%	83.3 \pm 10%	1,000	10 to 16

DIMENSIONS

mm inch

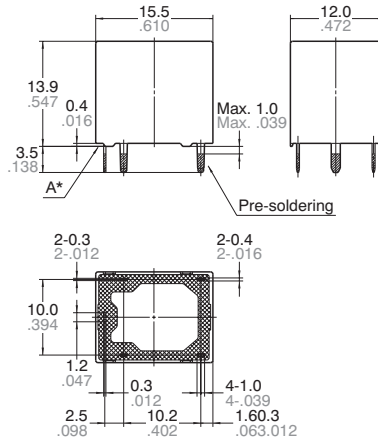

Schematic (Bottom view)

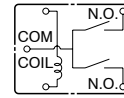

PC board pattern (Bottom view)

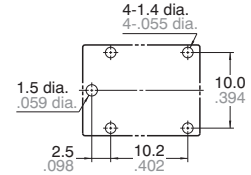

Tolerance: $\pm 0.1 \pm 0.004$

Dimension:

Max. 1mm .039 inch:
1 to 3mm .039 to .118 inch:
Min. 3mm .118 inch:

General tolerance

$\pm 0.1 \pm 0.004$
 $\pm 0.2 \pm 0.008$
 $\pm 0.3 \pm 0.012$

* Dimensions (thickness and width) of terminal in this catalog is measured before pre-soldering. Intervals between terminals is measured at A surface level.

EXAMPLE OF CIRCUIT

Control circuit for signal lights (security system)

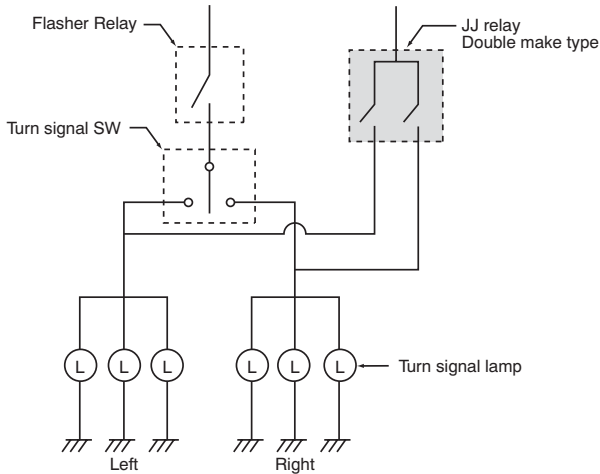

REFERENCE DATA

1. Coil temperature rise

Sample: JJM2w-12V, 6pcs.
Point measured: Inside the coil
Contact carrying current: 2 \times 6A, 2 \times 4A
Ambient temperature: Room temperature, 85°C 185°F

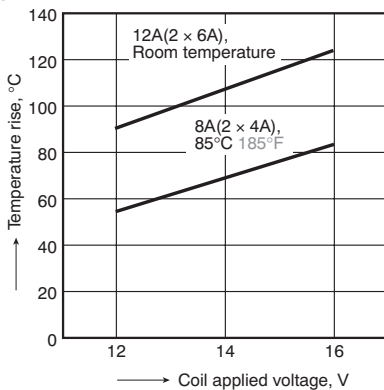

2. Ambient temperature and operating voltage range

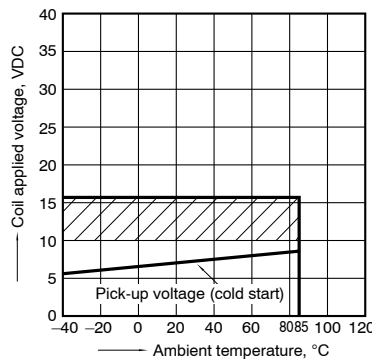

3. Distribution of pick-up and drop-out voltage

Sample: JJM2W-12V, 50pcs.

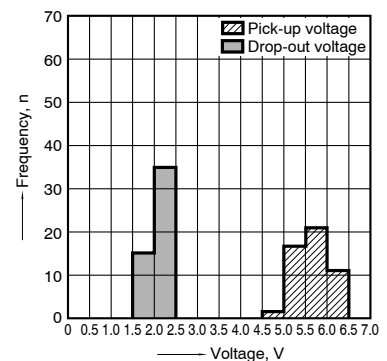

4. Distribution of operate time

Sample: JJM2W-12V, 50pcs.

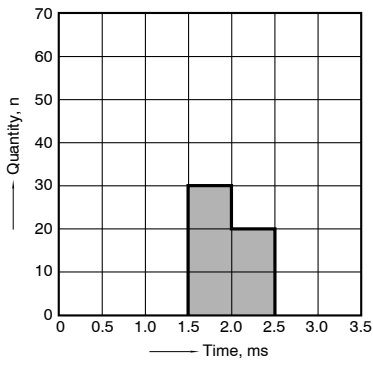

5. Distribution of release time

Sample: JJM2W-12V, 50pcs.

* Without diode

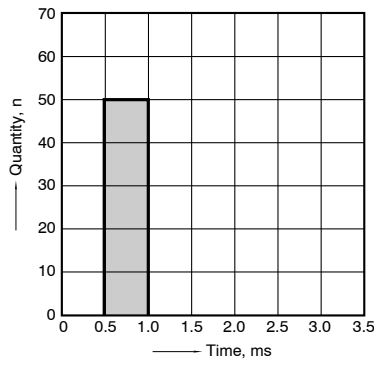

6. Electrical life test (Lamp load)

Sample: JJM2w-12V, 6pcs.

Load: 5.5A, inrush 48A, 6 x 21W

Operating frequency: (ON : OFF = 1s : 14s)

Ambient temperature: Room temperature

Circuit:

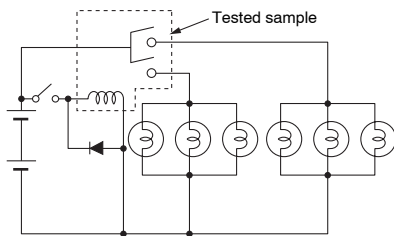

Load current waveform

Current value per contact on one side

Inrush current: 48A, Steady current: 5.5A

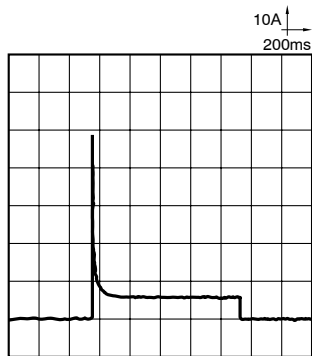

Change of pick-up and drop-out voltage

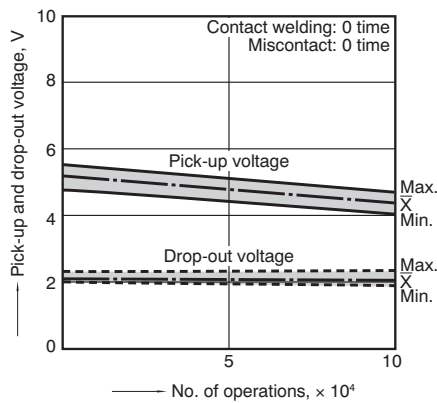

Change of contact resistance

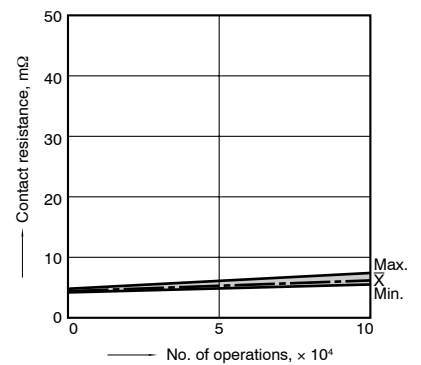

For Cautions for Use, see [Relay Technical Information](#).