

Sensor/actuator cable - SAC-4P- 5,0-PUR/M12FR-3L RRG - 1515798

Please be informed that the data shown in this PDF Document is generated from our Online Catalog. Please find the complete data in the user's documentation. Our General Terms of Use for Downloads are valid (<http://phoenixcontact.com/download>)



Sensor/actuator cable, 4-position, PUR halogen-free, black-gray RAL 7021, free cable end, on Socket angled M12, A-coded, with 3 LEDs, cable length: 5 m

As shown in the illustration but with different wire colors



Key Commercial Data

Packing unit	5 pc
Minimum order quantity	200 pc
GTIN	 4 017918 928445
GTIN	4017918928445
Weight per Piece (excluding packing)	151.000 g
Custom tariff number	85444290
Country of origin	Poland
Note	Made to Order (non-returnable)

Technical data

Dimensions

Length of cable	5 m
Stripping length of the free conductor end	50 mm

Ambient conditions

Degree of protection	IP65
	IP67
	IP68

General

Rated current at 40°C	4 A
Rated voltage	24 V
	24 V DC

Sensor/actuator cable - SAC-4P- 5,0-PUR/M12FR-3L RRG - 1515798

Technical data

General

Number of positions	4
Insulation resistance	≥ 100 MΩ
Coding	A - standard
Status display	3 LEDs
Overvoltage category	II
Degree of pollution	3
Insertion/withdrawal cycles	≥ 100

Material

Flammability rating according to UL 94	HB
Contact material	CuSn
Contact surface material	Ni/Au
Contact carrier material	TPU GF
Material of grip body	TPU, hardly inflammable, self-extinguishing
Material, knurls	Zinc die-cast, nickel-plated
Sealing material	NBR

Standards and Regulations

Flammability rating according to UL 94	HB
--	----

Cable

Cable type	PUR halogen-free black
Cable type (abbreviation)	PUR
Cable abbreviation	Li9Y11Y-HF
UL AWM style	20549 / 10493 (80°C/300 V)
Conductor cross section	4x 0.34 mm ²
AWG signal line	22
Conductor structure signal line	42x 0.10 mm
Core diameter including insulation	1.27 mm ±0.02 mm
Thickness, insulation	≥ 0.21 mm
Wire colors	brown, white, blue, black
Overall twist	4 wires, twisted
External sheath, color	black-gray RAL 7021
Outer sheath thickness	approx. 0.5 mm
External cable diameter D	4.2 mm ±0.15 mm
Minimum bending radius, fixed installation	5 x D
Minimum bending radius, flexible installation	10 x D
Number of bending cycles	10000000
Minimum bending radius, drag chain applications	10 x D
Traversing path	10 m
Traversing rate	3 m/s
Acceleration	10 m/s ²

Sensor/actuator cable - SAC-4P- 5,0-PUR/M12FR-3L RRG - 1515798

Technical data

Cable

Cable weight	30 kg/km
Outer sheath, material	PUR
Material conductor insulation	PP
Conductor material	Bare Cu litz wires
Insulation resistance	$\geq 1 \text{ G}\Omega \cdot \text{km}$
Conductor resistance	$\leq 58 \text{ }\Omega/\text{km}$
Nominal voltage, cable	$\leq 300 \text{ V}$
Test voltage, cable	$\geq 3000 \text{ V}$
Special properties	Flexible cable conduit capable
	Silicone-free
	Free of substances which would hinder coating with paint or varnish
	flexible
Flame resistance	in accordance with UL 758/1581 FT2
	DIN EN 60332-2-2 (20 s)
Halogen-free	in accordance with DIN VDE 0472 part 815
	in accordance with DIN EN 50267-2-1
Resistance to oil	in accordance with DIN EN 60811-2-1
Other resistance	Highly resistant to acids, alkaline solutions and solvents
	hydrolysis and microbe resistant
	partly UV-resistant in accordance with DIN EN ISO 4892-2-A
	Low adhesion
	abrasion-resistant
Ambient temperature (operation)	-40 °C ... 80 °C (cable, fixed installation)
	-25 °C ... 80 °C (cable, flexible installation)

Environmental Product Compliance

China RoHS	Environmentally friendly use period: unlimited = EFUP-e
	No hazardous substances above threshold values

Drawings

Sensor/actuator cable - SAC-4P- 5,0-PUR/M12FR-3L RRG - 1515798

Dimensional drawing

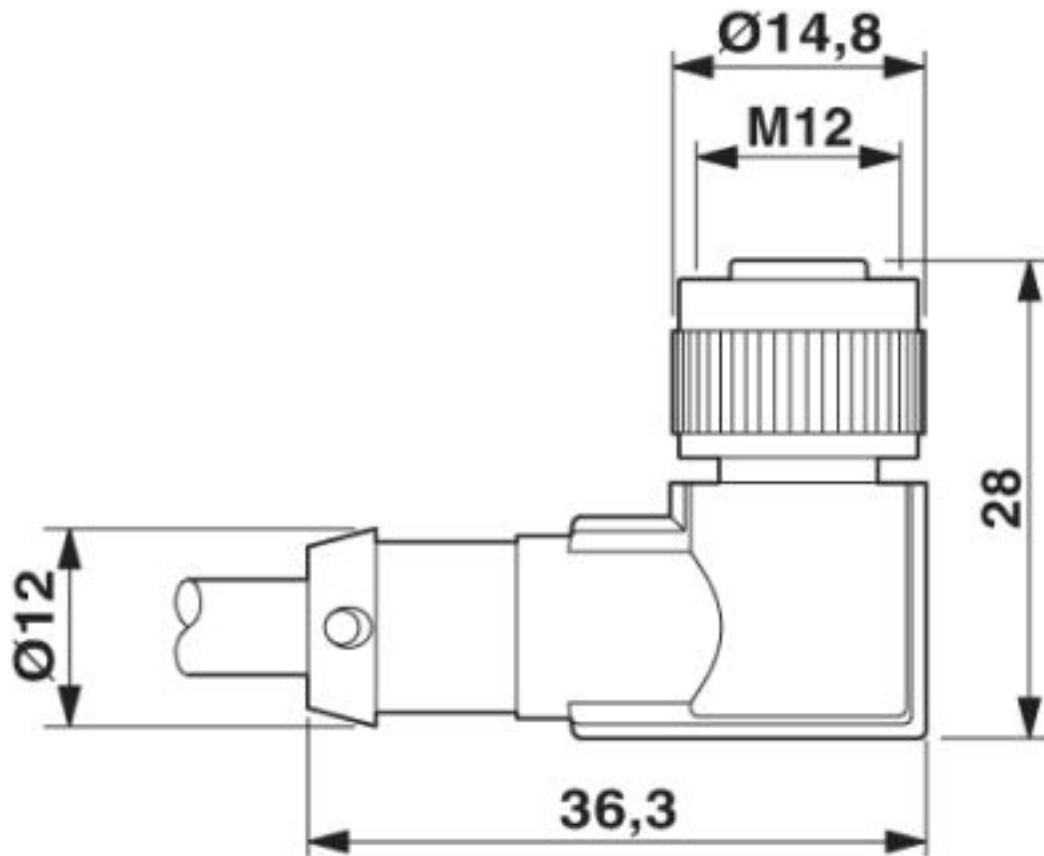

Socket M12 x 1, angled, with LED

Sensor/actuator cable - SAC-4P- 5,0-PUR/M12FR-3L RRG - 1515798

Circuit diagram

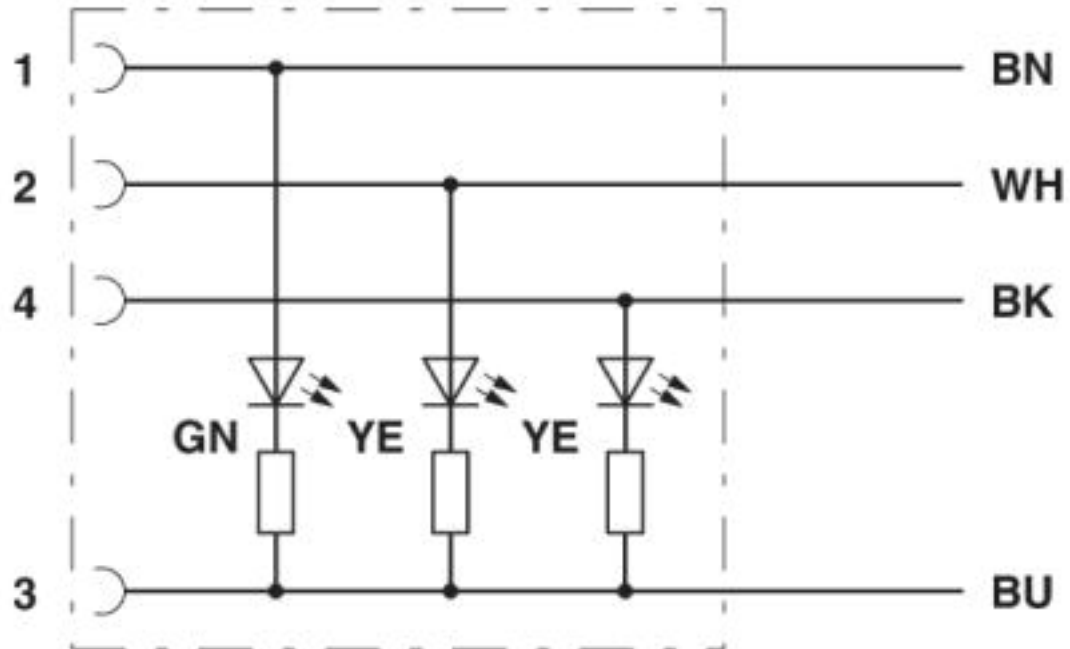

Contact assignment of M12 sockets with LED

Sensor/actuator cable - SAC-4P- 5,0-PUR/M12FR-3L RRG - 1515798

Schematic diagram

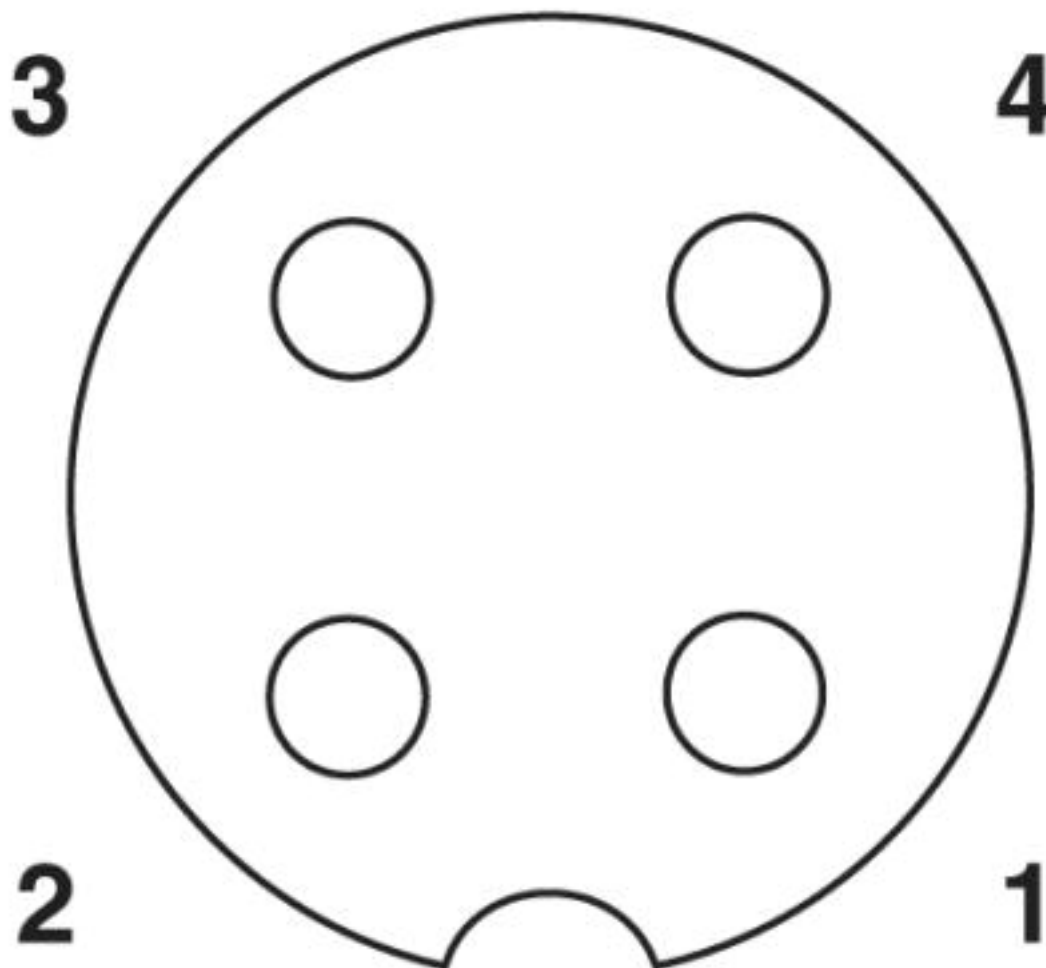

Pin assignment M12 socket, 4-pos., A-coded, view female side

Sensor/actuator cable - SAC-4P- 5,0-PUR/M12FR-3L RRG - 1515798

Cable cross section

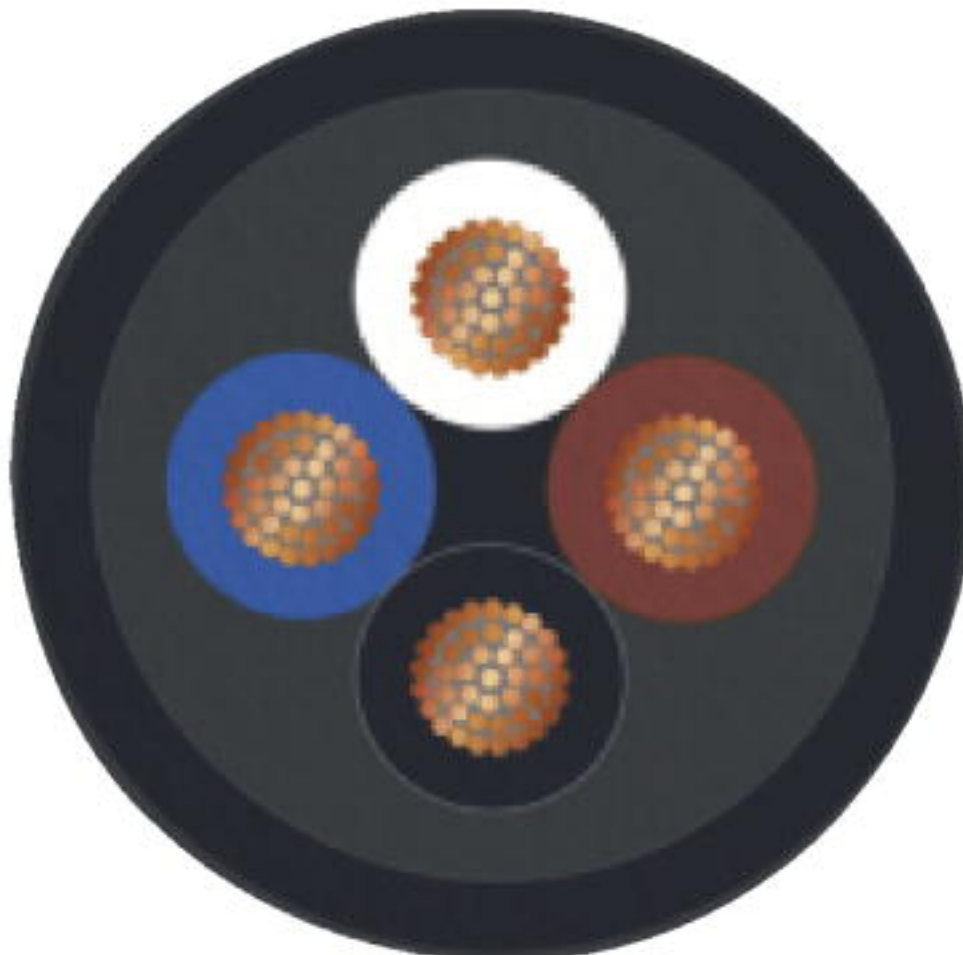

PUR halogen-free black [PUR]

Classifications

eCl@ss

eCl@ss 4.0	27060300
eCl@ss 4.1	27060300
eCl@ss 5.0	27061800
eCl@ss 5.1	27061800
eCl@ss 6.0	27279200
eCl@ss 7.0	27279218
eCl@ss 8.0	27279218
eCl@ss 9.0	27060311

Sensor/actuator cable - SAC-4P- 5,0-PUR/M12FR-3L RRG - 1515798

Classifications

ETIM

ETIM 2.0	EC000830
ETIM 3.0	EC001855
ETIM 4.0	EC001855
ETIM 5.0	EC001855
ETIM 6.0	EC001855
ETIM 7.0	EC001855

UNSPSC

UNSPSC 6.01	31251501
UNSPSC 7.0901	31251501
UNSPSC 11	31251501
UNSPSC 12.01	31251501
UNSPSC 13.2	31251501
UNSPSC 19.0	31251501
UNSPSC 20.0	31251501
UNSPSC 21.0	31251501

Approvals

Approvals

Approvals

UL Listed / cUL Listed / cULus Listed

Ex Approvals

Approval details

UL Listed		http://database.ul.com/cgi-bin/XYV/template/LISEXT/1FRAME/index.htm	FILE E 221474
Nominal voltage UN	24 V		
Nominal current IN	4 A		

cUL Listed		http://database.ul.com/cgi-bin/XYV/template/LISEXT/1FRAME/index.htm	FILE E 221474
Nominal voltage UN	24 V		

Sensor/actuator cable - SAC-4P- 5,0-PUR/M12FR-3L RRG - 1515798

Approvals

Nominal current I _N	4 A
--------------------------------	-----

cULus Listed	
--------------	---