

Fixing plate - FLT-ISG-PL-26 - 2905745

Please be informed that the data shown in this PDF Document is generated from our Online Catalog. Please find the complete data in the user's documentation. Our General Terms of Use for Downloads are valid (<http://phoenixcontact.com/download>)



Plate for fixing the FLT-ISG-100-EX isolating spark gap to a flange, drill hole diameter of 26 mm.



Key Commercial Data

Packing unit	1 pc
GTIN	 4 055626 002576
GTIN	4055626002576
Weight per Piece (excluding packing)	97.000 g
Custom tariff number	73269098
Country of origin	Germany
Note	Made to Order (non-returnable)

Technical data

General

Mounting type	Screw mounting
Material	St/tZn

Drawings

Fixing plate - FLT-ISG-PL-26 - 2905745

Dimensional drawing

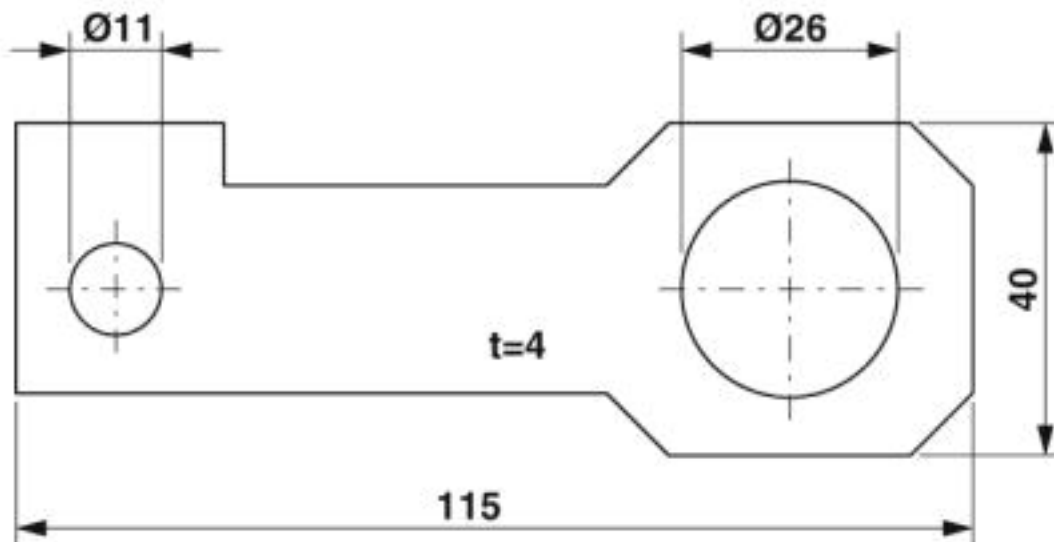

Classifications

eCl@ss

eCl@ss 4.0	27140200
eCl@ss 4.1	27140200
eCl@ss 5.0	27140200
eCl@ss 5.1	27140200
eCl@ss 6.0	27409200
eCl@ss 7.0	27409202
eCl@ss 8.0	27409202
eCl@ss 9.0	27400563

ETIM

ETIM 5.0	EC000490
ETIM 6.0	EC000482
ETIM 7.0	EC000482

UNSPSC

UNSPSC 13.2	39121708
UNSPSC 18.0	39121708
UNSPSC 19.0	39121708
UNSPSC 20.0	39121708
UNSPSC 21.0	39121708