

EMRE12C1H-200.000M TR

[Click part number to visit Part Number Details page](#)

REGULATORY COMPLIANCE (Data Sheet downloaded on Jan 9, 2020)



◀ Click badges to download compliance docs

Regulatory Compliance standards are subject to updates by governing bodies. Click the badges to download the latest compliance docs for this part number directly from Ecliptek.



ITEM DESCRIPTION

MEMS Clock Oscillators LVDS (DS) 2.5Vdc 6 Pad 5.0mm x 7.0mm Plastic Surface Mount (SMD) 200.000MHz \pm 100ppm over 0°C to +70°C

ELECTRICAL SPECIFICATIONS

Nominal Frequency	200.000MHz
Frequency Tolerance/Stability	\pm 100ppm Maximum over 0°C to +70°C (Inclusive of all conditions: Calibration Tolerance at 25°C, Frequency Stability over the Operating Temperature Range, Supply Voltage Change, Output Load Change, 1st Year Aging at 25°C, Reflow, Shock, and Vibration)
Aging at 25°C	\pm 1ppm Maximum First Year
Supply Voltage	2.5Vdc \pm 10%
Input Current	45mA Typical, 55mA Maximum (Excluding Load Termination Current)
Differential Output Error (dVod)	50mVdc Maximum
Differential Output Voltage (Vod)	200mVdc Minimum, 350mVdc Typical, 500mVdc Maximum
Offset Voltage (Vos)	1.125V Minimum, 1.20V Typical, 1.375V Maximum
Rise/Fall Time	500pSec Typical, 600pSec Maximum (Measured over 20% to 80% of waveform)
Duty Cycle	50 \pm 10(%) (Measured at 50% of waveform)
Offset Error (dVos)	50mVdc Maximum
Load Drive Capability	100 Ohms Between Output and Complementary Output
Output Logic Type	LVDS
Logic Control / Additional Output	Output Enable (OE) and Complementary Output
Output Control Input Voltage	Vih of 70% of Vdd Minimum or No Connect to Enable Output and Complementary Output, Vil of 30% of Vdd Maximum to Disable Output and Complementary Output (High Impedance)
Output Enable Current	35mA Maximum (OE) Without Load
RMS Phase Jitter	0.5pSec Typical, 1pSec Maximum (Fj = 12kHz to 20MHz; Random)
Period Jitter (Deterministic)	0.2pSec Typical
Period Jitter (Random)	1.0pSec Typical
Period Jitter (RMS)	1.4pSec Typical, 1.7pSec Maximum
Period Jitter (pk-pk)	15pSec Typical, 20pSec Maximum
Start Up Time	10mSec Maximum
Storage Temperature Range	-55°C to +125°C

ENVIRONMENTAL & MECHANICAL SPECIFICATIONS

ESD Susceptibility	MIL-STD-883, Method 3015, Class 2, HBM 2000V
Flammability	UL94-V0
Mechanical Shock	MIL-STD-883, Method 2002, Condition G, 30,000G
Moisture Resistance	MIL-STD-883, Method 1004
Moisture Sensitivity Level	J-STD-020, MSL 1
Resistance to Soldering Heat	MIL-STD-202, Method 210, Condition K
Resistance to Solvents	MIL-STD-202, Method 215
Solderability	MIL-STD-883, Method 2003 (Six I/O Pads on bottom of package only)
Temperature Cycling	MIL-STD-883, Method 1010, Condition B
Thermal Shock	MIL-STD-883, Method 1011, Condition B
Vibration	MIL-STD-883, Method 2007, Condition A, 20G

EMRE12C1H-200.000M TR [Click part number to visit Part Number Details page](#)

MECHANICAL DIMENSIONS (all dimensions in millimeters)

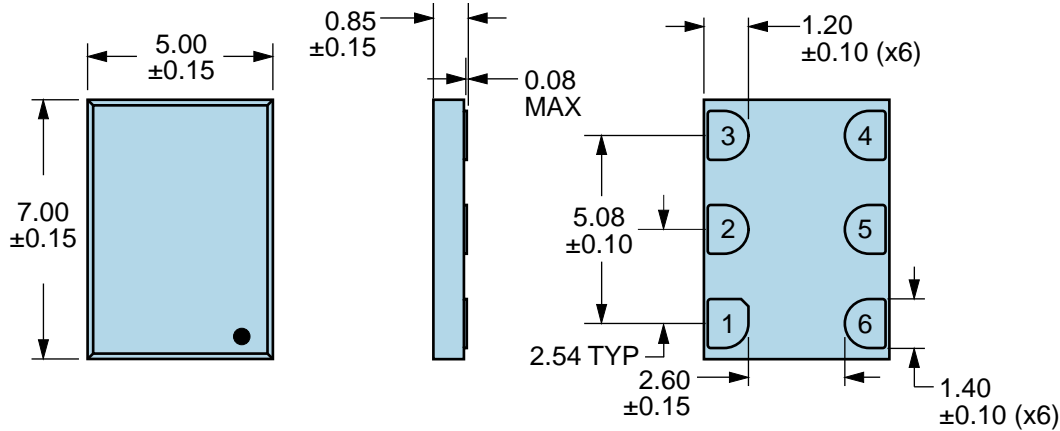

PIN	CONNECTION
1	Output Enable (OE)
2	No Connect
3	Case Ground
4	Output
5	Complementary Output
6	Supply Voltage

LINE	MARKING
1	XXXXXX XXXXXX=Ecliptek Manufacturing Lot Code

Suggested Solder Pad Layout

All Dimensions in Millimeters

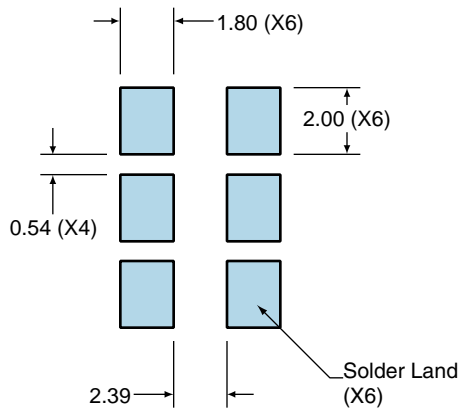

All Tolerances are ± 0.1

EMRE12C1H-200.000M TR [Click part number to visit Part Number Details page](#)

OUTPUT WAVEFORM & TIMING DIAGRAM

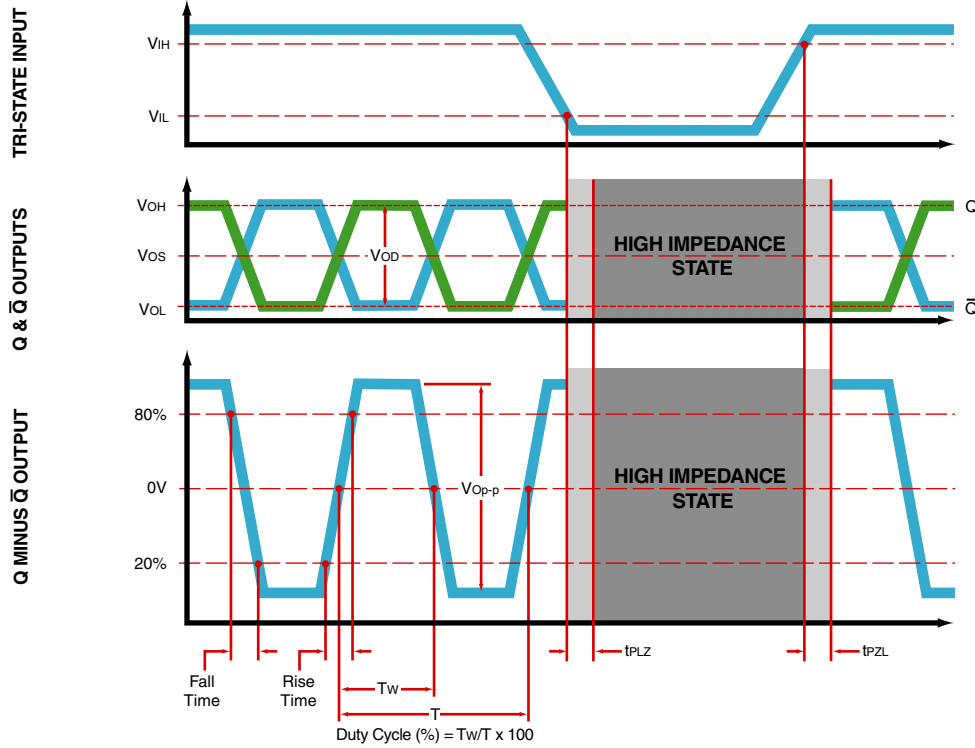

EMRE12C1H-200.000M TR [Click part number to visit Part Number Details page](#)

Test Circuit for Tri-State and Complementary Output

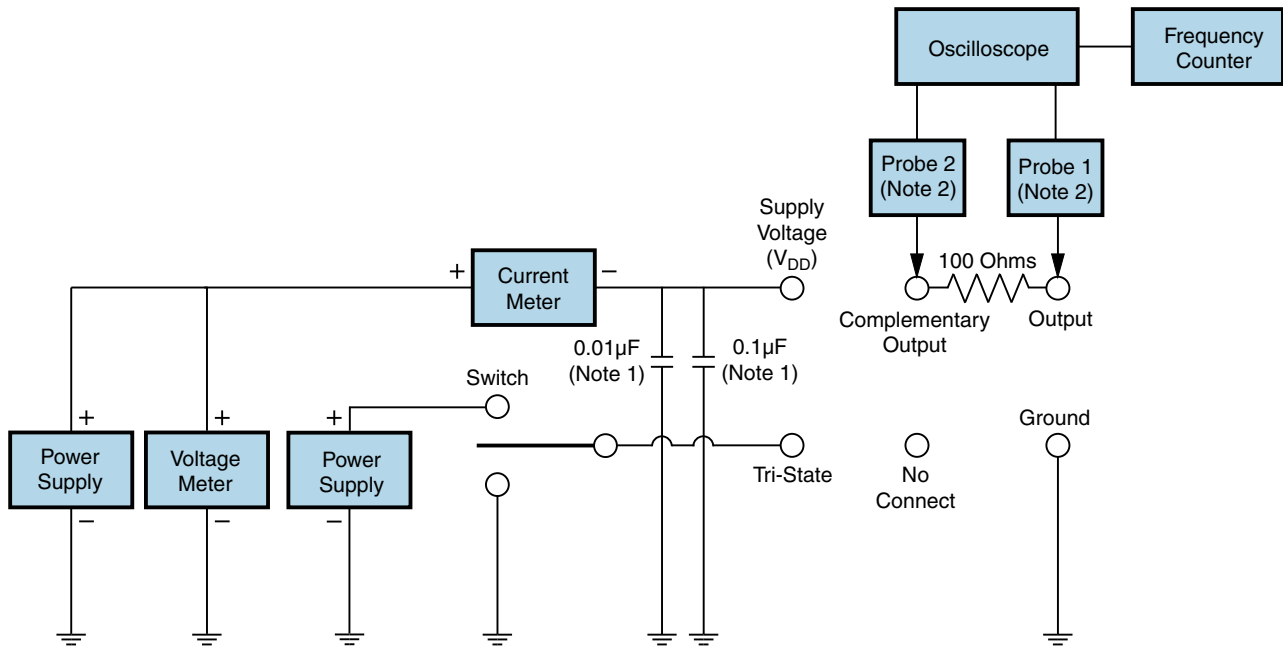

Note 1: An external $0.01\mu\text{F}$ ceramic bypass capacitor in parallel with a $0.1\mu\text{F}$ high frequency ceramic bypass capacitor close (less than 2mm) to the package ground and supply voltage pin is required.

Note 2: A low capacitance ($<12\text{pF}$), 10X attenuation factor, high impedance ($>10\text{Mohms}$), and high bandwidth ($>500\text{MHz}$) passive probe is recommended.

Note 3: Test circuit PCB traces need to be designed for a characteristic line impedance of 50 ohms.

EMRE12C1H-200.000M TR

Tape & Reel Dimensions

Quantity Per Reel: 1,000 units

All Dimensions in Millimeters

Compliant to EIA-481

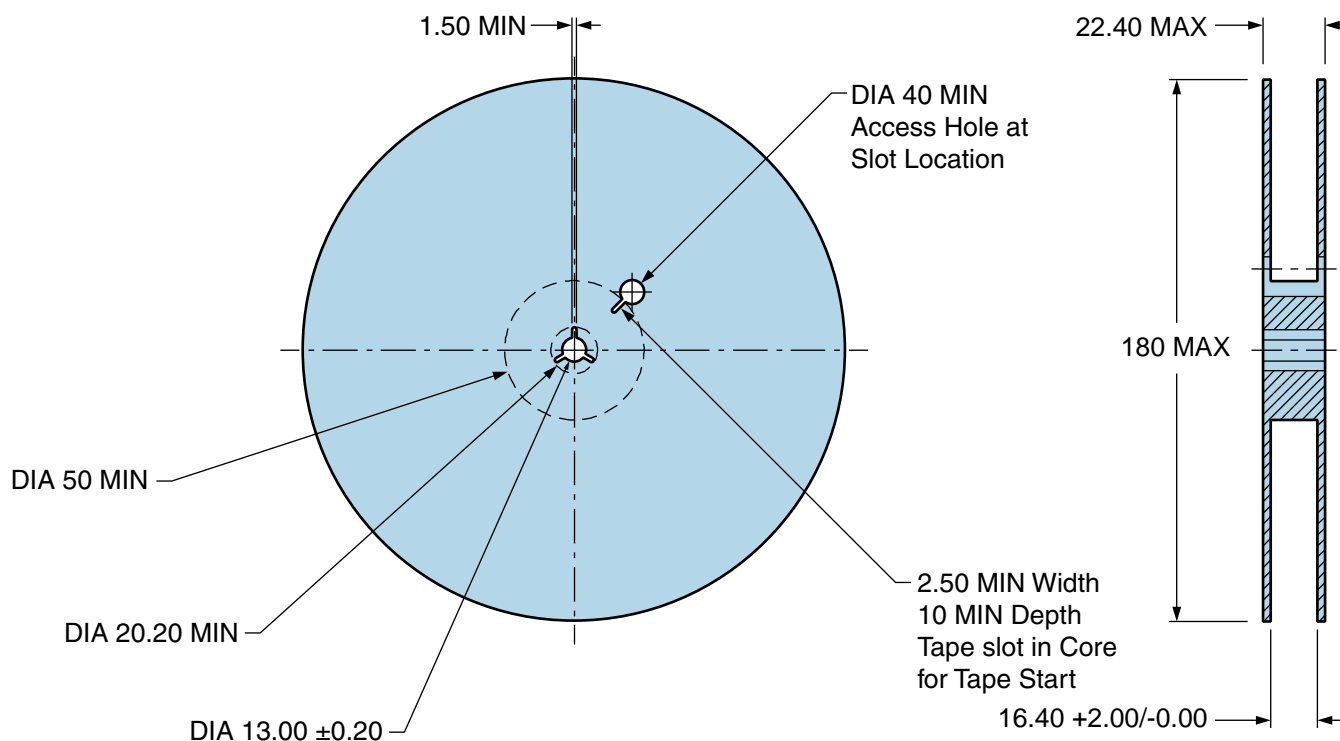
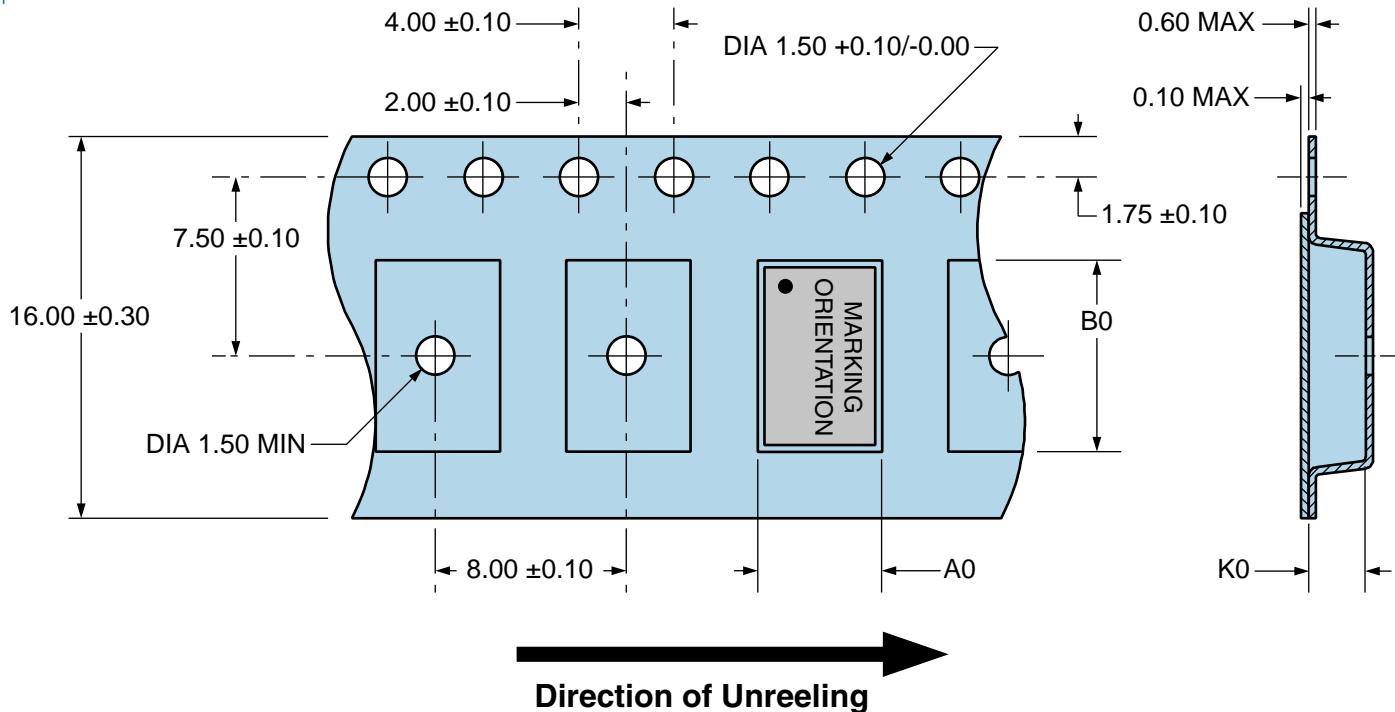

EMRE12C1H-200.000M TR [Click part number to visit Part Number Details page](#)

Recommended Solder Reflow Methods



High Temperature Infrared/Convection

Ts MAX to Tl (Ramp-up Rate) 3°C/Second Maximum

Preheat

- Temperature Minimum (Ts MIN) 150°C
 - Temperature Typical (Ts TYP) 175°C
 - Temperature Maximum (Ts MAX) 200°C
 - Time (ts MIN) 60 - 180 Seconds

Ramp-up Rate (Tl to Tp) 3°C/Second Maximum

Time Maintained Above:

- Temperature (Tl) 217°C
 - Time (tL) 60 - 150 Seconds

Peak Temperature (Tp) 260°C Maximum for 10 Seconds Maximum

Target Peak Temperature (Tp Target) 250°C +0/-5°C

Time within 5°C of actual peak (tp) 20 - 40 Seconds

Ramp-down Rate 6°C/Second Maximum

Time 25°C to Peak Temperature (t) 8 Minutes Maximum

Moisture Sensitivity Level Level 1

EMRE12C1H-200.000M TR [Click part number to visit Part Number Details page](#)

Recommended Solder Reflow Methods

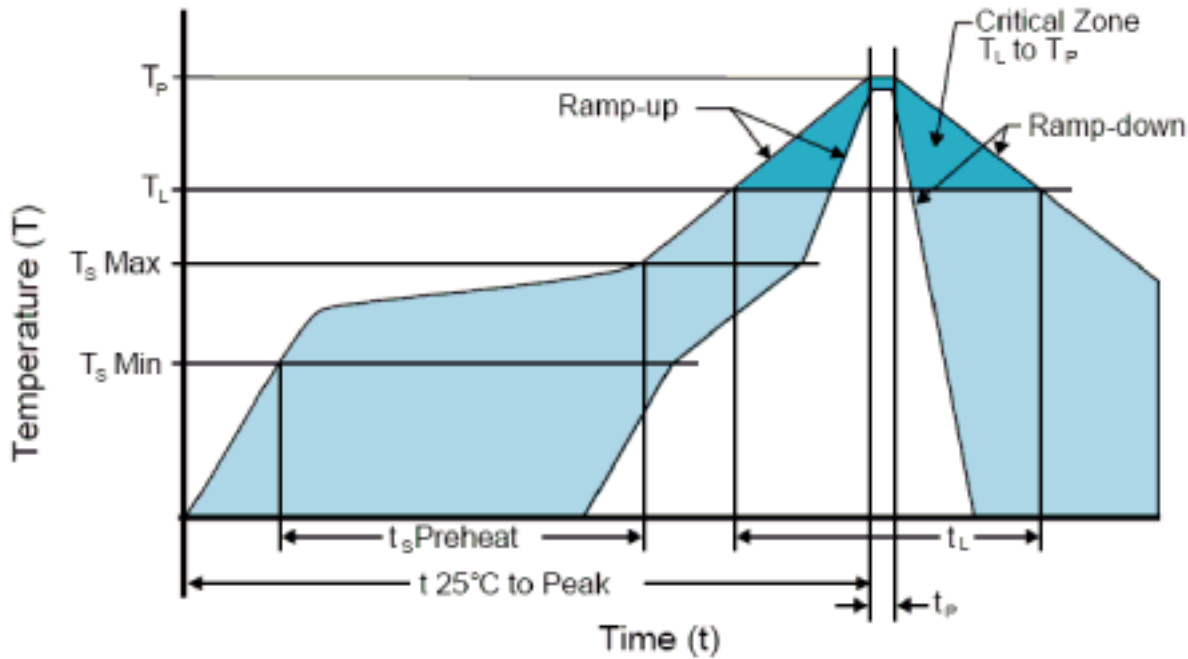

Low Temperature Infrared/Convection 240°C

Ts MAX to TL (Ramp-up Rate)	5°C/Second Maximum
Preheat	
- Temperature Minimum (Ts MIN)	N/A
- Temperature Typical (Ts TYP)	150°C
- Temperature Maximum (Ts MAX)	N/A
- Time (ts MIN)	60 - 120 Seconds
Ramp-up Rate (TL to TP)	5°C/Second Maximum
Time Maintained Above:	
- Temperature (TL)	150°C
- Time (tL)	200 Seconds Maximum
Peak Temperature (TP)	240°C Maximum
Target Peak Temperature (TP Target)	240°C Maximum 2 Times / 230°C Maximum 1 Time
Time within 5°C of actual peak (tp)	10 Seconds Maximum 2 Times / 80 Seconds Maximum 1 Time
Ramp-down Rate	5°C/Second Maximum
Time 25°C to Peak Temperature (t)	N/A
Moisture Sensitivity Level	Level 1

Low Temperature Manual Soldering

185°C Maximum for 10 Seconds Maximum, 2 times Maximum.

High Temperature Manual Soldering

260°C Maximum for 5 Seconds Maximum, 2 times Maximum.