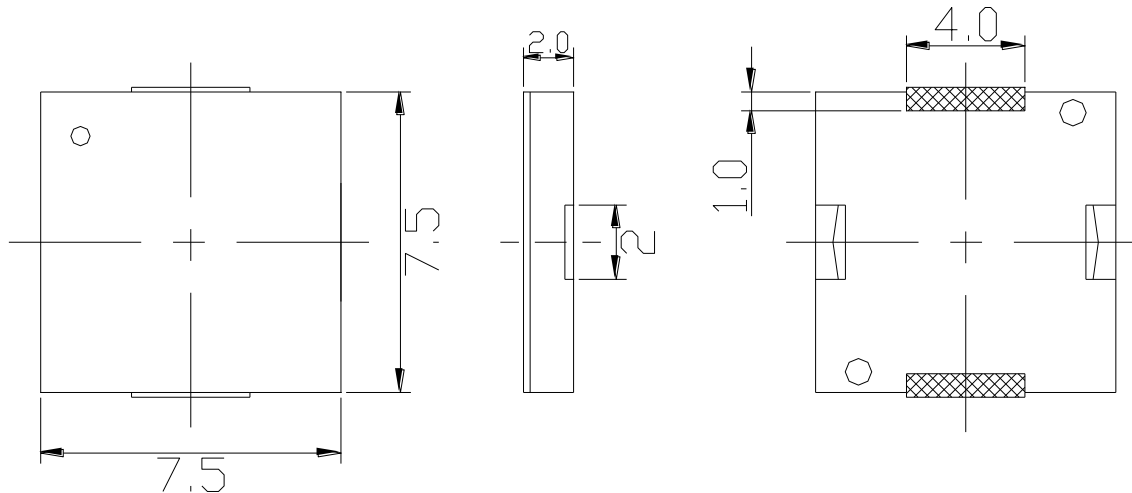

Specifications:

Resonant Frequency (Hz)	6000
Operating Voltage (Vpp)	1 ~ 25
Rated Voltage (Vpp)	3.0
Current Consumption Max. (mA)	6 at 12 Vpp
Sound Pressure Level Min. (dB)	74 at 10cm at 12Vpp
Capacitance (pF)	6,000 ±30%
Operating Temperature (°C)	-40 ~ +85
Storage Temperature (°C)	-40 ~ +85
Housing	LCP Plastic Resin (Color: Black)
Type of Connection	SMD
Condition by wave soldering (°C)	250 ±5 / within 5 sec
Condition by hand soldering (°C)	350 ±20 / within 5 sec
Weight (Grams)	0.2
Options	For other options contact factory

Dimensions: (units: mm)**ROHS Compliant****Packaging:** Parts are supplied on cut tape.