

TIMEGUARD®

Dedicated PIR Light Controller c/w RF remote control for LEDPRO Floodlights

Model: LEDPRORFKB - Black

Model: LEDPRORFKWH - White

Model: LEDPROFOB RF Remote Fob



Installation & Operating Instructions

1. General Information

These instructions should be read carefully and retained for further reference and maintenance.

2. Safety

- Before installation or maintenance, ensure the mains supply to the PIR sensor is switched off and the circuit supply fuses are removed or the circuit breaker turned off.
- It is recommended that a qualified electrician is consulted or used for the installation of this PIR sensor and install in accordance with the current IEE wiring and Building Regulations.
- Check that the total load on the circuit including when this PIR sensor is fitted does not exceed the rating of the circuit cable, fuse or circuit breaker.

3. Technical Specifications

PIR Light Controller

- Operating Voltage: 230V AC 50Hz
- This product is of Class I Construction and must be earthed.
- Detection Angle: 180°

- Motion Detection Range:
Up to 12m distance at a 2.5m mounting height
- Maximum Switchable Load;
140W LED Lighting
1000W Halogen Lighting
200W CFL Lighting
500W Fluorescent tube w/o PF correction
- Time ON Adjustment: 3 seconds – 18 minutes
- Warm Up Period: Approximately 35 seconds
- Dusk (LUX) Level Adjustment: 2 – 1000 Lux
- Operating Temperature: -20°C to +40°C
- Standby (W): <0.5W
- Manual Override Mode:
ON/OFF operation using RF Remote Fob (6 fobs max)
- Sensor Head Adjustment:
Pan angle = Left/right 90°, Tilt angle = Down 150°
- RF Module: RX Receiver
- RF Frequency: 433.92MHz
- IP55 Rated suitable for restricted external applications
- CE Compliant
- Dimensions (H x W x D): 114 x 78 x 127mm

RF Remote Fob

- Battery: 3V (1x CR2032)
- Battery Life:
Approximately 24 months (@ 10x opt/day)
- Class Rating: Class III

- Transmission and Receiving Distance:
100m hand held (clear line of sight)
10m when mounted inside a wall switch
(recommended mounting height = 1.2m)
- Total number of fobs usable per PIR: 6
- Operating Temperature: -20°C to +40°C
- RF Module: TX Transmitter
- RF Frequency: 433.72MHz to 434.12MHz
- IP44 Rated suitable for restricted external applications
- CE Compliant
- Dimensions (H x W x D): 60 x 38 x 15mm

4. Pack contents

- 1x LEDPRORFKB-WH Dedicated PIR Light Controller
c/w RF remote control for LEDPRO Floodlights
- 1x LEDPROFOB RF Remote Fob
- 1x Instruction Manual
- 1x 3V CR2032 Battery
- 1x Lens Sticker
- 2x Wire (for wall mounting a fob)

5. Selecting a Location

- The light controller has number of detection zones, at various vertical and horizontal angles as shown (see diagram A).

- A moving human body needs to cross/enter one of these zones to activate the light controller. The best all-round coverage is achieved with the unit mounted at the optimum height of 2.5 metres.
- Careful positioning of the light controller will be required to ensure optimum performance (see diagram A detailing detection range and direction).
- The light controller is more sensitive to movement ACROSS its field of vision than to movement directly TOWARDS (see diagram B). Therefore position the unit so that the light controller looks ACROSS the likely approach path.
- Avoid positioning the light controller where there are any sources of heat in the detection area (extractor fans, tumble dryer exhausts etc.) including opposite any other light sources such as other security lights.
- Reflective surfaces (i.e. pools of water or white painted walls) and overhanging branches may cause false activation under extreme conditions.

- During extreme weather conditions the motion light controller may exhibit unusual behaviour. This does not indicate a fault with the light controller. Once normal weather conditions return, the light controller will resume normal operation.

TOP VIEW



A



B

← Less sensitive
(Typically 2m walking towards)



↑ More sensitive
(up to 12m)

SIDE VIEW

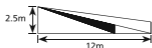

5

6. Installation

- 6.1 Ensure the mains supply is switched off and the circuit supply fuses are removed or the circuit breaker turned off.



- 6.2 An isolating switch should be installed to enable the power to be switched ON & OFF for maintenance purposes.

6.3 Remove the jumper plug from the floodlight.

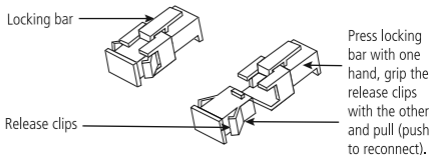

6.4 Pass the 230V 50Hz mains supply and load cables the holes provided on the PIR ensuring that a cable gland, grommet or sealing compound is used to maintain the IP rating.

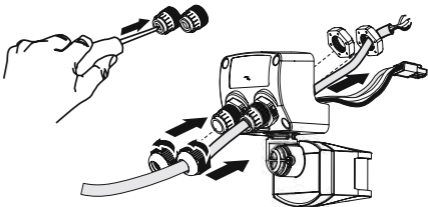

6.5 Terminate the cables into the terminal block ensuring correct polarity is observed and that all bare conductors are sleeved (See section 7. Connection Diagram).

6.6 Ensure that all connections are secure.

- 6.7 Connect the 3 way PIR plug, by pushing the plug and socket inside the floodlight together until they lock. DO NOT FORCE. THE PLUG AND SOCKET WILL ONLY FIT TOGETHER ONE WAY AROUND (See Jumper Plug diagram).
- 6.8 Secure the PIR to the floodlight using the 4 fixing screws.

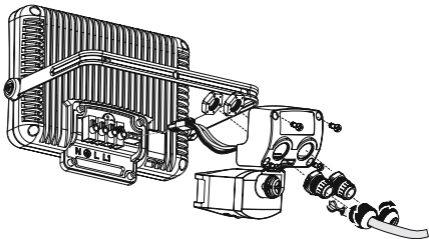

7. Connection Diagram

- Connect the cables to the terminal block as follows;

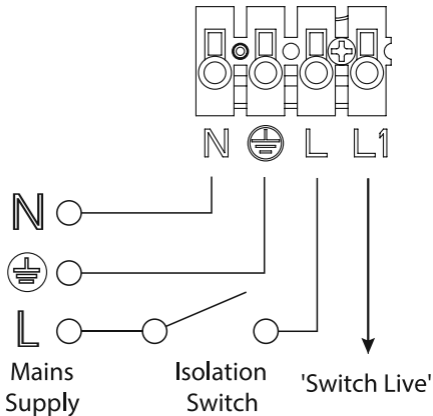

- Note: The Switch Live terminal is for additional standalone floodlights (see section 3. Technical Specifications for maximum switchable loads). Any floodlight connected to the L1 switch live terminal 'Live Output' will be controlled by the PIR

8. Setting Up

Walk Test Procedure (Test Mode)

- The sensor will rotate from left to right, and will tilt downwards. Adjust the light controller to point in the required direction and angle down to limit forward range as required.

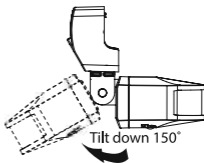
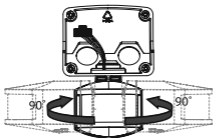

- Set the two adjustment controls on the underside of the unit to the following positions:



Dusk/Dawn



Test mode



Time

TIME ADJUST – Fully anti-clockwise

DUSK/DAWN LEVEL ADJUST – Fully clockwise

- Turn the power to the unit ON.

- The floodlight will illuminate for approximately 35 seconds. This indicates the unit is wired correctly. The unit is in Test Mode when the light turns OFF.
- If the detection area is too big for your requirements, try angling the PIR light controller head downwards. This will reduce the detection area should a smaller coverage be required.

Setting Up for Automatic Operation (Auto Mode)

- When walk tests are complete, the unit can be set into Auto Mode.
- The TIME ADJUST setting controls how long the unit remains illuminated following activation and after all motion ceases.
- The minimum time (fully anti-clockwise) is approx. 3 seconds, whilst the maximum time (fully clockwise) is approximately 18 minutes.
- Set the control to the desired setting between these limits.
- The DUSK/DAWN LEVEL ADJUST control determines the level of darkness required for the unit to start operating. The DUSK adjustment knob is indicated by the 'Moon' and 'Sun' symbols).

- Set the light threshold to maximum (fully clockwise/Sun end), then turn the control anti-clockwise about three quarters of the way round to the Moon end. This will give operation after DUSK approximately.
- For a more accurate setting of the DUSK/DAWN LEVEL ADJUST control turn it fully anti-clockwise (Moon end) and leave for at least 20 seconds for the unit to settle.
- When the ambient light level reaches that required for DUSK, adjust the DUSK control a small amount clockwise pausing to try to get the unit to detect and turn the lights under control ON by moving a hand slowly backwards and forwards across the front of the detector lens for around 5 seconds.
- Continue to turn the control small amounts in a clockwise direction, stopping after each adjustment to try to get the unit to detect as above.
- Eventually detection will occur and the DUSK level is now set as required.

9. Masking the PIR Light Controller Lens

- To reduce the PIR light controllers coverage, preventing detection in unwanted areas, mask the PIR light controllers lens using the lens sticker supplied.
- The top section of the lens covers long range detection, the bottom covers short range. Similarly the left and right lens sections cover the left and right detection area respectively.
- Mask the PIR Light controllers lens to suit your installation.

12

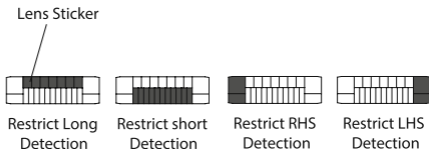

10. RF Remote Fob

Battery

- To access the battery holder, remove the back plate from the fob as shown in the diagram.

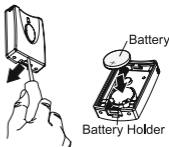

Pairing the RF Remote Fob(s) with the PIR Light Controller

Note: You must complete the Walk Test Procedure before you can pair the devices. The pairing of the fob(s) cannot be actioned with the PIR light controller set to Test Mode. Make sure the PIR light controller is functioning correctly and set for Automatic Operation (Auto Mode) before you continue.

- Press the centre button that is located on the bottom of the PIR light controller once (do not press and hold for longer than 4 seconds), the lamp will flash twice to indicate it is ready to pair your fob(s).

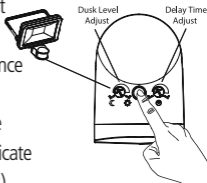

Note: once the lamp has flashed twice, the PIR sensor will no longer trigger the lamp with motion until the pairing sequence has been completed.

- Press the fob button once. The lamp will turn ON for 3 seconds, and back OFF again, to indicate it has been registered.

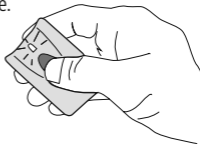

Note: If you have more than one fob to pair (Up to 6 max) then press the fob buttons, one at a time, waiting for the lamp to turn ON for 3 seconds and back OFF again each time, between presses. You cannot pair a 7th fob. If attempted, the lamp will flash twice to indicate it has not been paired.

- After the last fob press, wait for approximately 30 seconds until the lamp flashes twice. This will indicate that your fob(s) have successfully been paired.

Note: once the lamp has flashed twice, the PIR light controller will begin to trigger with motion once again.

- Test your fob(s) by pressing the fob button once to turn the lamp ON, and once to turn the lamp OFF. If you are using more than fobs, you are able to turn the lamp ON using one fob, and turn the lamp OFF using another.

Erase all RF Remote Fobs from the PIR Light Controller

- Press and hold the centre button, located on the bottom of the PIR light controller, for approximately 5 seconds. The lamp will flash 5 times. This indicates that un-pairing has been successful.

Installing a RF Remote Fob into a Wall Switch

- Remove the rubber caps from the bottom of the fob as shown.

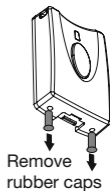

- Using 2 of the wires supplied, push them firmly into the 2 spring clamp terminals. Check they are both secure with a light tug.

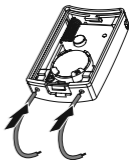

- Follow the wall switch wiring image for connection.

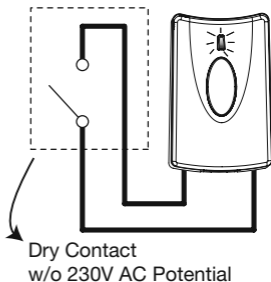

11. Troubleshooting Guide

PROBLEM

- Lamp stays ON all the time night and day.
- Lamp stays ON all the time at night, or PIR keeps activating at random for no apparent reason

SOLUTION

Check wiring connections.

Wires to L and L' terminals may be transposed.

The unit may be suffering from false activation. Cover the sensor lens completely with black PVC tape. This will prevent the sensor from 'seeing' anything. If the unit now switches off after the set time duration and does not re-activate, this indicated that the problem was caused by false activation. The problem may be solved by slightly adjusting the direction/angle of the sensor head (see previous section). If however, the unit continues to remain ON or to operate randomly then the unit is faulty and should be replaced.

You may not be allowing the unit time to complete its warm-up period. Stand well out of the detection range and wait (the warm-up period should never exceed 5 minutes). Occasionally, winds may activate the sensor. Sometimes passages between buildings etc. can cause a "wind tunnel" effect. Ensure the unit is not positioned so as to allow detection of cars/people using public thoroughfares adjacent to your property. Ensure that the unit is mounted securely, even the slightest movement can result in a false detection.

- PIR sensor will not operate at all. Check that the power is switched ON at the circuit breaker/internal wall switch. Turn OFF the power to the unit and check the wiring connections as per the diagram (see 7. Connection Diagram). Ensure no connections are loose. Check the bulb (if it's replaceable). If the bulb has failed, replace (do not hold the bulb directly with fingers, use a tissue or clean dry cloth). Where relevant, ensure the bulb is seated correctly in the bulb holder.
- The PIR sensor will not operate at night. Refer to section 8. Setting Up for DUSK control adjustment.
- Unit activates during the daytime. Refer to section 8. Setting Up for DUSK control adjustment.

- PIR coverage is poor/ sporadic. Unit may be poorly located. See Section 5. Selecting a Location and re-locate the unit.
- Detection range varies from day to day. PIR sensors are influenced by climatic conditions. The colder the ambient temperature, the more effective the sensor will be. You may need to make seasonal adjustments to the sensor head position to ensure trouble-free operation all year round.

3 Year Guarantee

In the unlikely event of this product becoming faulty due to defective material or manufacture within 3 years of the date of purchase, please return it to your supplier in the first year with proof of purchase and it will be replaced free of charge. For the second and third years or any difficulty in the first year telephone the helpline on 020 8450 0515.

Note: A proof of purchase is required in all cases. For all eligible replacements (where agreed by Timeguard) the customer is responsible for all shipping/postage charges outside of the UK. All shipping costs are to be paid in advance before a replacement is sent out.



If you experience problems, do not immediately return the unit to the store.

Telephone the Timeguard Customer Helpline:

HELPLINE
020 8450 0515

or email helpline@timeguard.com

Qualified Customer Support Coordinators will be online to assist in resolving your query.



A **theben** Group Company

For a product brochure please contact:

Timeguard Limited.

Victory Park, 400 Edgware Road,
London NW2 6ND

Sales Office: 020 8452 1112
or email csc@timeguard.com

www.timeguard.com

67.058.622 (Issue 2)