

LQM18PN1R0NC0#

indicates a package specification code.



< List of part numbers with package codes >
 LQM18PN1R0NC0L , LQM18PN1R0NC0B

Shape

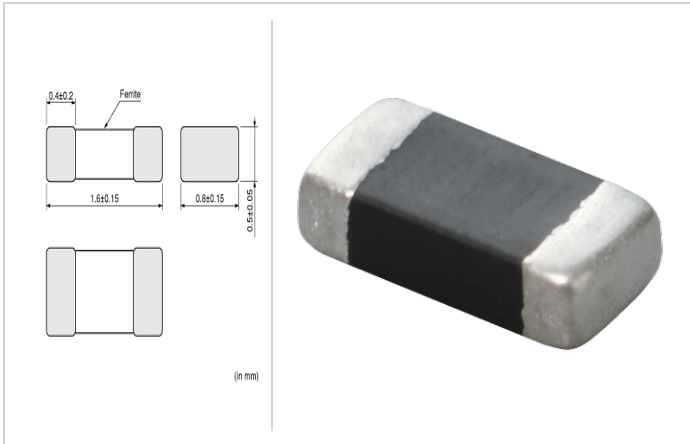

L size	1.6 ±0.15mm
W size	0.8 ±0.15mm
T size	0.5 ±0.05mm
Size code in inch (mm)	0603 (1608)

References

Packaging code	Specifications	Minimum quantity
L	φ 180mm Embossed taping	4000
B	Packing in bulk	1000

Mass (Typ.)	
1 piece	0.003g

Specifications

Inductance	1.0μH ±30%
Inductance test frequency	1MHz
Rated current (Itemp) (Based on Temperature rise)	750mA
Max. of DC resistance	0.25Ω
Avg. of DC resistance	0.20Ω ±25%
Self resonance frequency (min.)	50MHz
Operating temperature range	-55°C to 125°C
Class of magnetic shield	Ferrite Core
Series	LQM18PN_C0

Attention

- 1.This datasheet is downloaded from the website of Murata Manufacturing Co., Ltd. Therefore, it's specifications are subject to change or our products in it may be discontinued without advance notice. Please check with our sales representatives or product engineers before ordering.
- 2.This datasheet has only typical specifications because there is no space for detailed specifications. Therefore, please review our product specifications or consult the approval sheet for product specifications before ordering.

Chart of characteristic data (The charts below may show another part number which shares its characteristics.)

▪ Inductance-Frequency characteristics (Typ.)

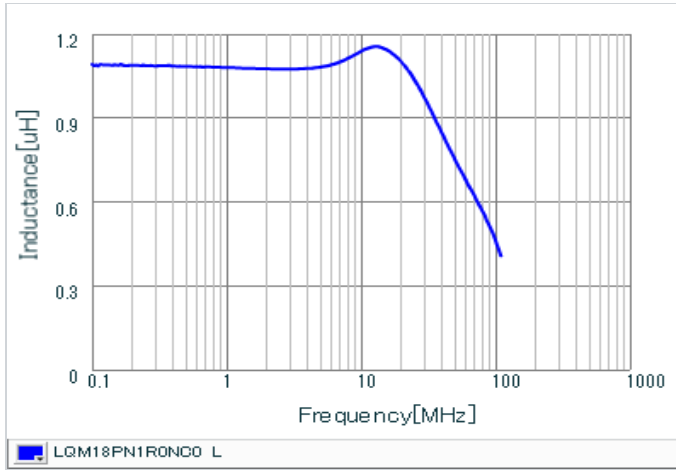

▪ Inductance-Current characteristics (Typ.)

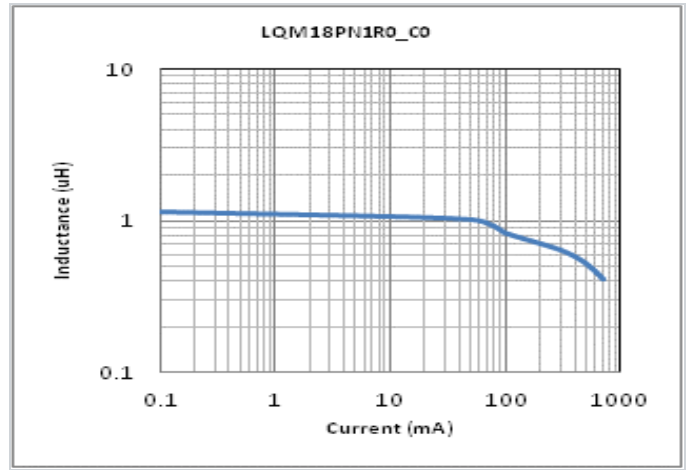

▪ Temperature rise characteristics (Typ.)

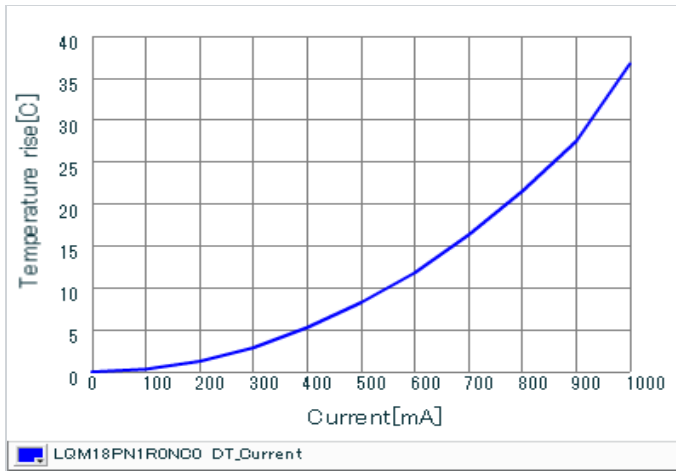

⚠ Attention

- 1.This datasheet is downloaded from the website of Murata Manufacturing Co., Ltd. Therefore, it's specifications are subject to change or our products in it may be discontinued without advance notice. Please check with our sales representatives or product engineers before ordering.
- 2.This datasheet has only typical specifications because there is no space for detailed specifications. Therefore, please review our product specifications or consult the approval sheet for product specifications before ordering.