

LQP02TN1N9B02#

"#" indicates a package specification code.



< List of part numbers with package codes >
 LQP02TN1N9B02L , LQP02TN1N9B02D , LQP02TN1N9B02B

Shape

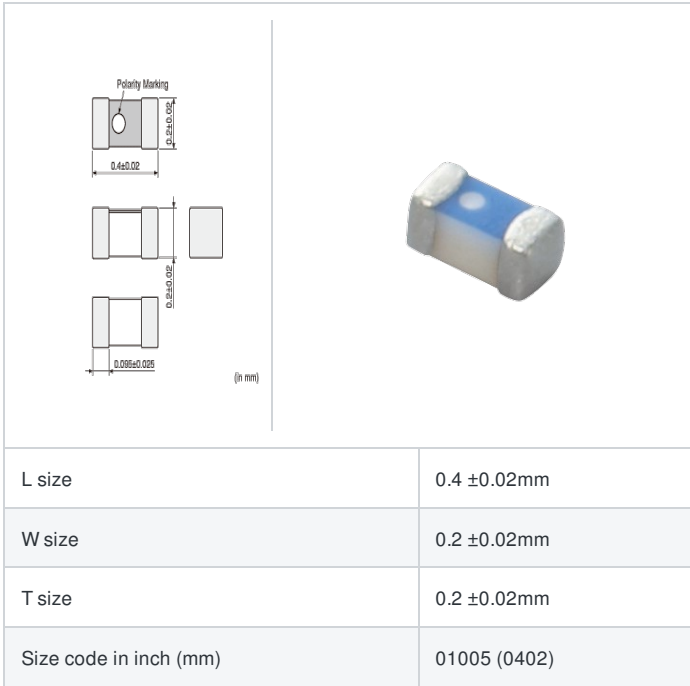

References

Packaging code	Specifications	Minimum quantity
D	φ 180mm Paper taping	20000
L	φ 180mm Embossed taping	40000
B	Packing in bulk	500

Mass (Typ.)	
1 piece	0.00005g

Specifications

Inductance	1.9nH ±0.1nH
Inductance test frequency	500MHz
Rated current (Itemp) (Based on Temperature rise)	200mA
Max. of DC resistance	0.75Ω
Q (min.)	8
Q test frequency	500MHz
Self resonance frequency (min.)	9000MHz
Operating temperature range (Self-temperature rise is not included)	-55°C to 125°C
Series	LQP02TN_02

Attention

- 1.This datasheet is downloaded from the website of Murata Manufacturing Co., Ltd. Therefore, it's specifications are subject to change or our products in it may be discontinued without advance notice. Please check with our sales representatives or product engineers before ordering.
- 2.This datasheet has only typical specifications because there is no space for detailed specifications. Therefore, please review our product specifications or consult the approval sheet for product specifications before ordering.

Chart of characteristic data (The charts below may show another part number which shares its characteristics.)

▪ Inductance-Frequency characteristics (Typ.)

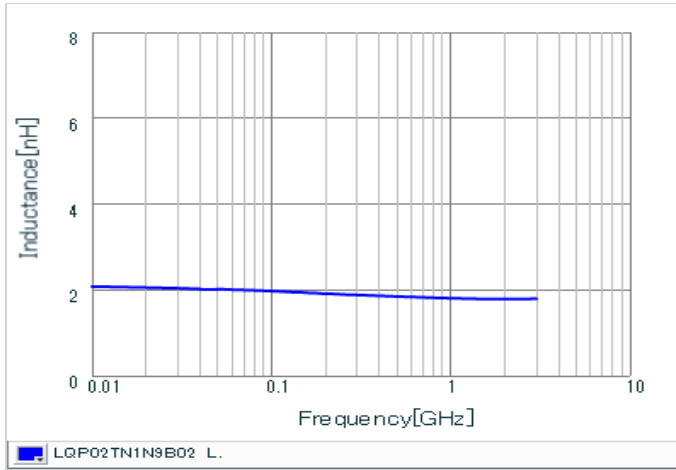

▪ Q-Frequency characteristics (Typ.)

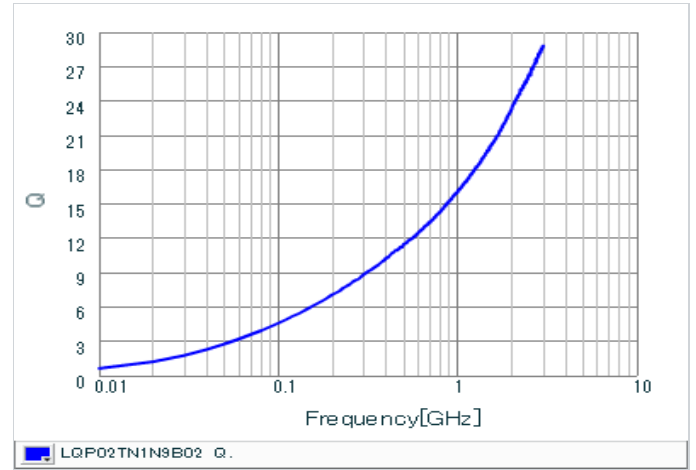

⚠ Attention

- 1.This datasheet is downloaded from the website of Murata Manufacturing Co., Ltd. Therefore, it's specifications are subject to change or our products in it may be discontinued without advance notice. Please check with our sales representatives or product engineers before ordering.
- 2.This datasheet has only typical specifications because there is no space for detailed specifications.
Therefore, please review our product specifications or consult the approval sheet for product specifications before ordering.