

LQH5BPN4R7N38#

"#" indicates a package specification code.



< List of part numbers with package codes >
LQH5BPN4R7N38L , LQH5BPN4R7N38K

Shape

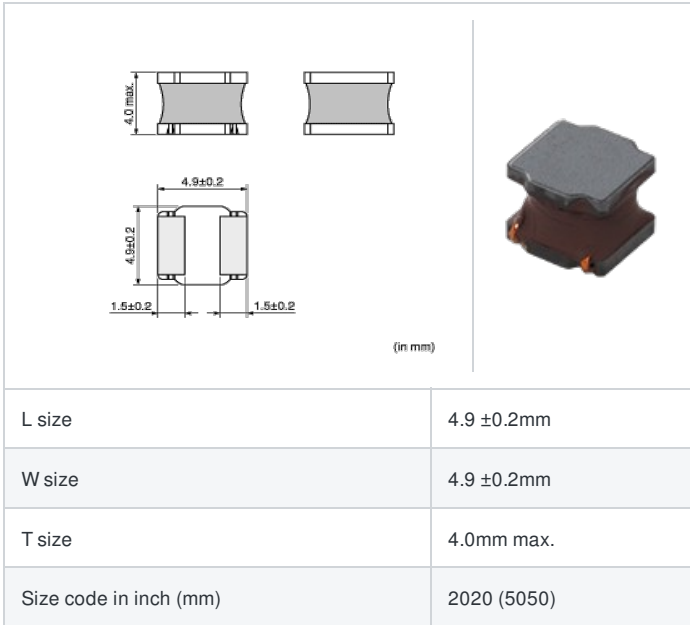

Notes

When rated current is applied to the products, inductance will be within ±30% of initial inductance value range.
When rated current is applied to the products, the temperature rise caused by self-generated heat shall be limited to 40°C max. (ambient temperature 85°C).
Keep the temperature (ambient temperature plus self-generation of heat) under 125°C.

References

Packaging code	Specifications	Minimum quantity
L	φ180mm Embossed taping	400
K	φ330mm Embossed taping	1500

Mass (Typ.)	
1 piece	0.35g

Specifications

Inductance	4.7μH ±30%
Inductance test frequency	100kHz
Rated current (I _{sat}) (Based on Inductance change)	3500mA
Rated current (I _{temp}) (Based on Temperature rise)	3800mA
Max. of DC resistance	0.0312Ω
Avg. of DC resistance	0.026Ω ±20%
Self resonance frequency (min.)	17MHz
Operating temperature range (Self-temperature rise is included)	-40°C to 125°C
Operating temperature range (Self-temperature rise is not included)	-40°C to 85°C
Class of magnetic shield	Magnetic Resin
Series	LQH5BPN_38

Attention

- This datasheet is downloaded from the website of Murata Manufacturing Co., Ltd. Therefore, it's specifications are subject to change or our products in it may be discontinued without advance notice. Please check with our sales representatives or product engineers before ordering.
- This datasheet has only typical specifications because there is no space for detailed specifications. Therefore, please review our product specifications or consult the approval sheet for product specifications before ordering.

Chart of characteristic data (The charts below may show another part number which shares its characteristics.)

▪ Inductance-Frequency characteristics (Typ.)

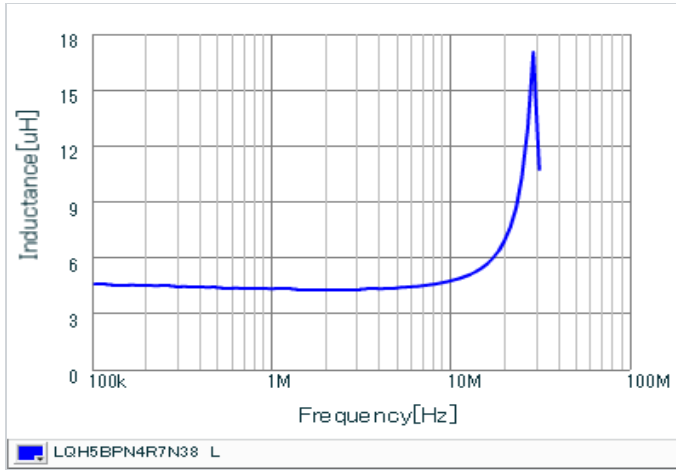

▪ Inductance-Current characteristics (Typ.)

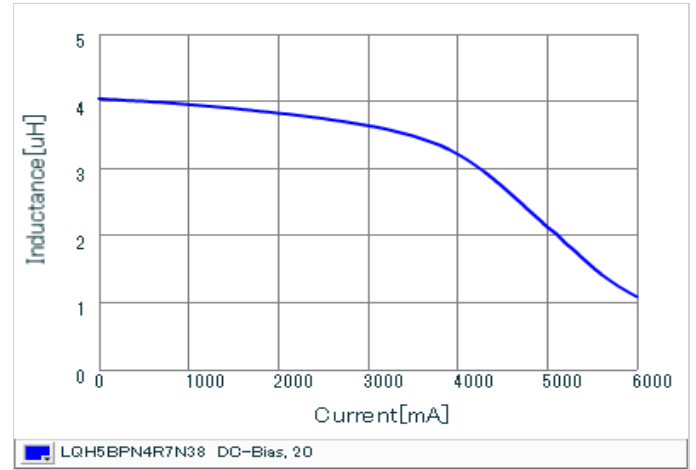

▪ Temperature rise characteristics (Typ.)

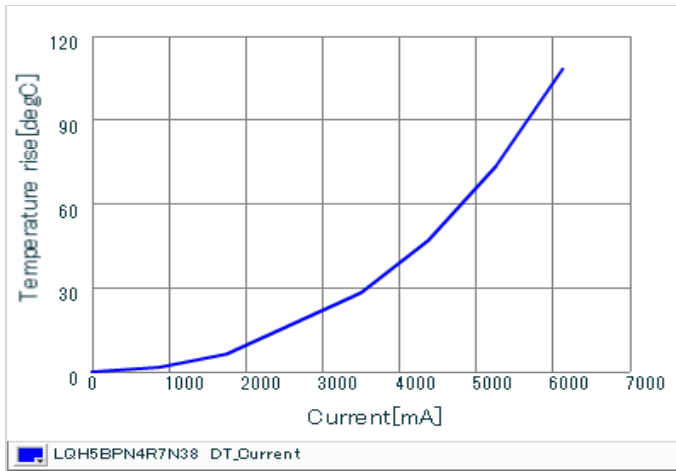

⚠ Attention

- 1.This datasheet is downloaded from the website of Murata Manufacturing Co., Ltd. Therefore, it's specifications are subject to change or our products in it may be discontinued without advance notice. Please check with our sales representatives or product engineers before ordering.
- 2.This datasheet has only typical specifications because there is no space for detailed specifications. Therefore, please review our product specifications or consult the approval sheet for product specifications before ordering.