

LQW15CAR11K00#

indicates a package specification code.



< List of part numbers with package codes >
LQW15CAR11K00D , LQW15CAR11K00B

Shape

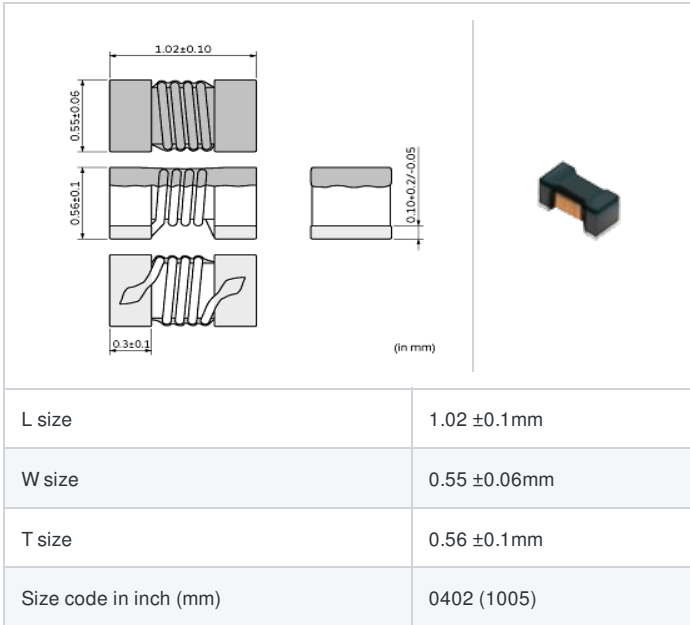

Notes

Typical impedance: 580Ω (typ) @ 900MHz/1000Ω (typ) @ 1.7GHz

References

Packaging code	Specifications	Minimum quantity
D	φ180mm Paper taping	10000
B	Packing in bulk	500

Mass (Typ.)	
1 piece	0.0012g

Specifications

Inductance	110nH ±10%
Inductance test frequency	10MHz
Rated current (Itemp) (Based on Temperature rise)	900mA
Max. of DC resistance	0.13Ω
Self resonance frequency (min.)	1600MHz
Operating temperature range (Self-temperature rise is included)	-40°C to 125°C
Class of magnetic shield	No Shield
Series	LQW15CA_00

Attention

- 1.This datasheet is downloaded from the website of Murata Manufacturing Co., Ltd. Therefore, it's specifications are subject to change or our products in it may be discontinued without advance notice. Please check with our sales representatives or product engineers before ordering.
- 2.This datasheet has only typical specifications because there is no space for detailed specifications. Therefore, please review our product specifications or consult the approval sheet for product specifications before ordering.

Chart of characteristic data (The charts below may show another part number which shares its characteristics.)

▪ Inductance-Frequency characteristics (Typ.)

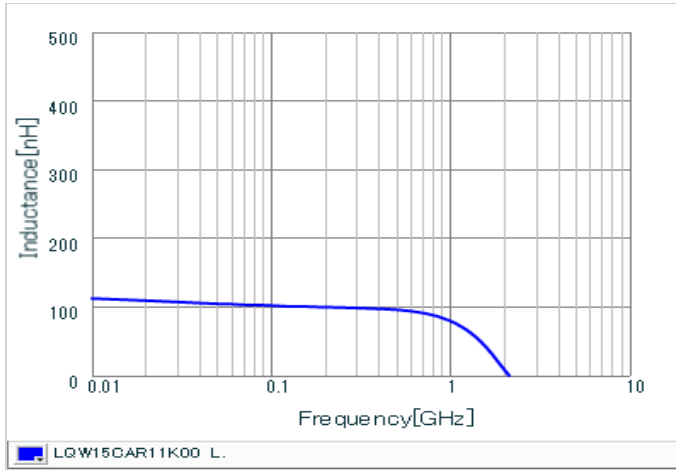

▪ Q-Frequency characteristics (Typ.)

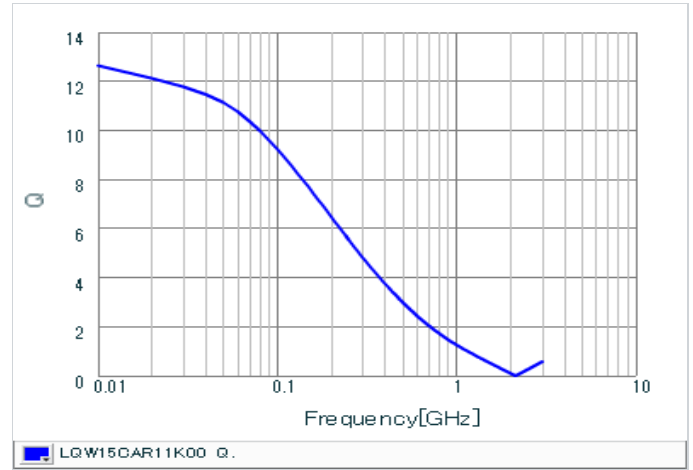

⚠ Attention

- 1.This datasheet is downloaded from the website of Murata Manufacturing Co., Ltd. Therefore, it's specifications are subject to change or our products in it may be discontinued without advance notice. Please check with our sales representatives or product engineers before ordering.
- 2.This datasheet has only typical specifications because there is no space for detailed specifications.
Therefore, please review our product specifications or consult the approval sheet for product specifications before ordering.