

# LQW18AN75NJ0Z#

# indicates a package specification code.



< List of part numbers with package codes >  
 LQW18AN75NJ0ZD , LQW18AN75NJ0ZJ , LQW18AN75NJ0ZB

## Shape

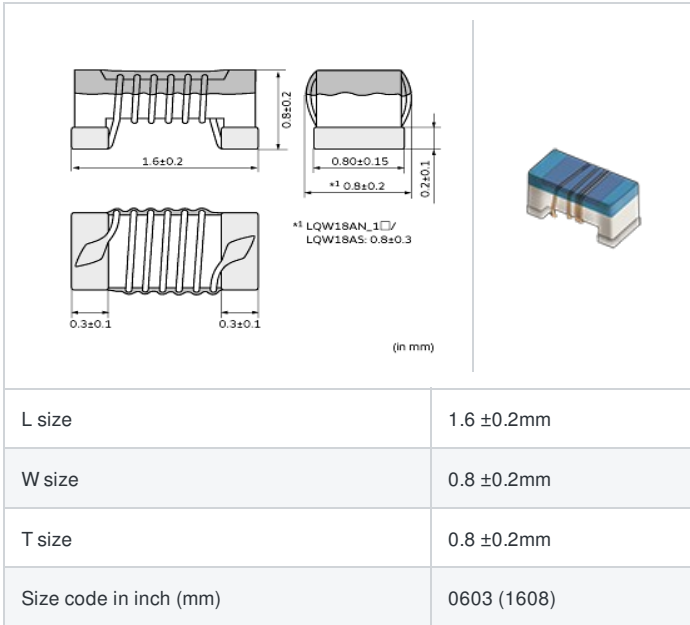

## References

Packaging code	Specifications	Minimum quantity
D	φ180mm Paper taping	4000
J	φ330mm Paper taping	10000
B	Packing in bulk	500

Mass (Typ.)	
1 piece	0.003g

## Specifications

Inductance	75nH ±5%
Inductance test frequency	100MHz
Rated current (Itemp) (Based on Temperature rise)	270mA
Max. of DC resistance	0.56Ω
Q (min.)	34
Q test frequency	150MHz
Self resonance frequency (min.)	2050MHz
Operating temperature range (Self-temperature rise is not included)	-55°C to 125°C
Series	LQW18AN_0Z

### Attention

- 1.This datasheet is downloaded from the website of Murata Manufacturing Co., Ltd. Therefore, it's specifications are subject to change or our products in it may be discontinued without advance notice. Please check with our sales representatives or product engineers before ordering.
- 2.This datasheet has only typical specifications because there is no space for detailed specifications. Therefore, please review our product specifications or consult the approval sheet for product specifications before ordering.

**Chart of characteristic data (The charts below may show another part number which shares its characteristics.)**

▪ Inductance-Frequency characteristics (Typ.)

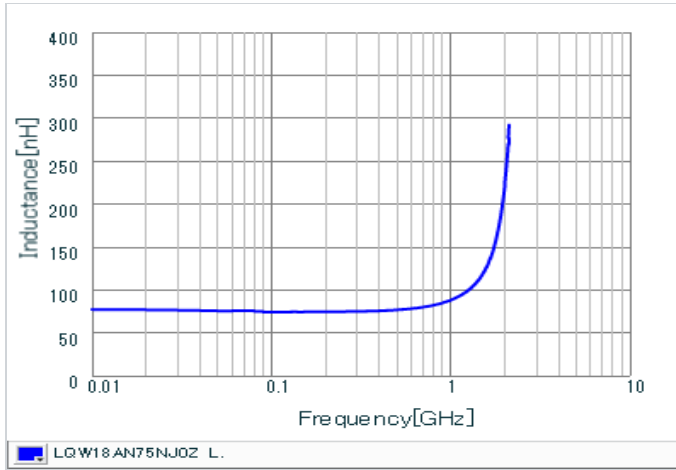

▪ Q-Frequency characteristics (Typ.)

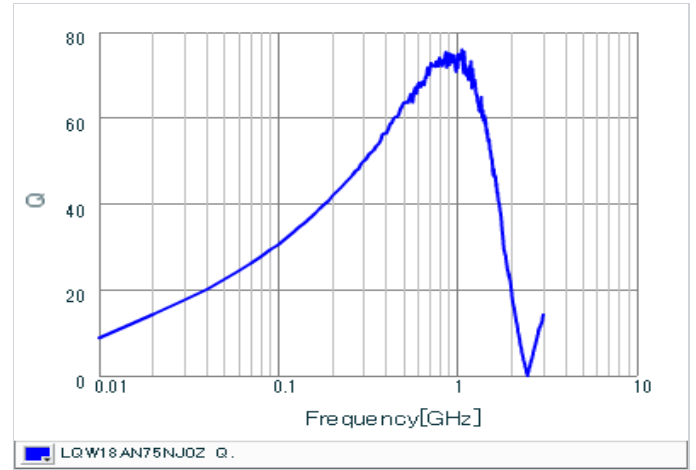

**⚠ Attention**

- 1.This datasheet is downloaded from the website of Murata Manufacturing Co., Ltd. Therefore, it's specifications are subject to change or our products in it may be discontinued without advance notice. Please check with our sales representatives or product engineers before ordering.
- 2.This datasheet has only typical specifications because there is no space for detailed specifications.  
Therefore, please review our product specifications or consult the approval sheet for product specifications before ordering.